



# MORGAN AND MORECAMBE OFFSHORE WIND FARMS: TRANSMISSION ASSETS

## Outline Highway Access Management Plan



~~September~~ December 2024  
Rev: F024

MOR001-FLO-CON-ENV-PLN-0059  
MRCNS-J3303-RPS-10076

PINS Reference: EN020028  
APFP Regulations: 5(2)(j)  
Document reference: J8/F02

Document status					
Version	Purpose of document	Approved by	Date	Approved by	Date
F01	For issue	AS	September 2024	IM	September 2024
<a href="#">F02</a>	<a href="#">S51 advice update</a>	<a href="#">AS</a>	<a href="#">December 2024</a>	<a href="#">IM</a>	<a href="#">December 2024</a>

The report has been prepared for the exclusive use and benefit of the Applicants and solely for the purpose for which it is provided. Unless otherwise agreed in writing by RPS Group Plc, any of its subsidiaries, or a related entity (collectively 'RPS') no part of this report should be reproduced, distributed or communicated to any third party. RPS does not accept any liability if this report is used for an alternative purpose from which it is intended, nor to any third party in respect of this report. The report does not account for any changes relating to the subject matter of the report, or any legislative or regulatory changes that have occurred since the report was produced and that may affect the report.

The report has been prepared using the information provided to RPS by its client, or others on behalf of its client. To the fullest extent permitted by law, RPS shall not be liable for any loss or damage suffered by the client arising from fraud, misrepresentation, withholding of information material relevant to the report or required by RPS, or other default relating to such information, whether on the client's part or that of the other information sources, unless such fraud, misrepresentation, withholding or such other default is evident to RPS without further enquiry. It is expressly stated that no independent verification of any documents or information supplied by the client or others on behalf of the client has been made. The report shall be used for general information only.

**Prepared by:**

**RPS**

**Prepared for:**

**Morgan Offshore Wind Limited,  
Morecambe Offshore Windfarm Ltd**

# Contents

<b>1</b>	<b>OUTLINE HIGHWAY ACCESS MANAGEMENT PLAN .....</b>	<b>1</b>
1.1	Background .....	1
1.1.1	Introduction .....	1
1.1.2	Project overview .....	1
1.1.3	Purpose of the Outline Highway Access Management Plan .....	2
1.1.4	Structure of this document .....	2
1.1.5	Implementation of the Outline Highway Access Management Plan .....	3
1.2	Highway accesses .....	4
1.3	Access designs .....	12
1.3.2	Haul road crossings of public highways .....	25
1.3.3	Road safety .....	26
1.3.4	Technical approval .....	26
1.3.5	Road safety audit .....	27
1.4	Traffic management for temporary highway access points .....	27
1.4.1	Overview .....	27
1.4.2	Road works .....	27
1.5	References .....	33
<del>1</del>	<del>OUTLINE HIGHWAY ACCESS MANAGEMENT PLAN .....</del>	<del>1</del>
<del>1.1</del>	<del>Background .....</del>	<del>1</del>
<del>1.1.1</del>	<del>Introduction .....</del>	<del>1</del>
<del>1.1.2</del>	<del>Project overview .....</del>	<del>1</del>
<del>1.1.3</del>	<del>Purpose of the Outline Highway Access Management Plan .....</del>	<del>2</del>
<del>1.1.4</del>	<del>Structure of this document .....</del>	<del>2</del>
<del>1.1.5</del>	<del>Implementation of the Outline Highway Access Management Plan .....</del>	<del>3</del>
<del>1.2</del>	<del>Highway accesses .....</del>	<del>4</del>
<del>1.3</del>	<del>Access designs .....</del>	<del>9</del>
<del>1.3.2</del>	<del>Haul road crossings of public highways .....</del>	<del>22</del>
<del>1.3.3</del>	<del>Road safety .....</del>	<del>23</del>
<del>1.3.4</del>	<del>Technical approval .....</del>	<del>23</del>
<del>1.3.5</del>	<del>Road safety audit .....</del>	<del>24</del>
<del>1.4</del>	<del>Traffic management for temporary highway access points .....</del>	<del>24</del>
<del>1.4.1</del>	<del>Overview .....</del>	<del>24</del>
<del>1.4.2</del>	<del>Road works .....</del>	<del>24</del>
<del>1.5</del>	<del>References .....</del>	<del>30</del>
<del>1</del>	<del>OUTLINE HIGHWAY ACCESS MANAGEMENT PLAN .....</del>	<del>1</del>
<del>1.1</del>	<del>Background .....</del>	<del>1</del>
<del>1.1.1</del>	<del>Introduction .....</del>	<del>1</del>
<del>1.1.2</del>	<del>Project overview .....</del>	<del>1</del>
<del>1.1.3</del>	<del>Purpose of the Outline Highway Access Management Plan .....</del>	<del>2</del>
<del>1.1.4</del>	<del>Structure of this document .....</del>	<del>2</del>
<del>1.1.5</del>	<del>Implementation of the Outline Highway Access Management Plan .....</del>	<del>3</del>
<del>1.2</del>	<del>Highway accesses .....</del>	<del>4</del>
<del>1.3</del>	<del>Access designs .....</del>	<del>6</del>
<del>1.3.2</del>	<del>Haul road crossings of public highways .....</del>	<del>19</del>
<del>1.3.3</del>	<del>Road safety .....</del>	<del>20</del>
<del>1.3.4</del>	<del>Technical approval .....</del>	<del>20</del>
<del>1.3.5</del>	<del>Road safety audit .....</del>	<del>24</del>
<del>1.4</del>	<del>Traffic management for temporary highway access points .....</del>	<del>24</del>
<del>1.4.1</del>	<del>Overview .....</del>	<del>24</del>
<del>1.4.2</del>	<del>Road works .....</del>	<del>24</del>

4.5—References .....	27
----------------------	----

## Tables

Table 1.1: Preliminary access design summary .....	13
<del>Table 1.1: Preliminary access design summary .....</del>	<del>10</del>
<del>Table 1.1: Preliminary access design summary .....</del>	<del>7</del>

## Figures

Figure 1.1: Construction highway accesses and haul road crossing points (West) .....	8
Figure 1.2: Construction highway accesses and haul road crossing points (East) .....	10
Figure 1.3: Haul route crossing .....	25
Figure 1.4: Priority signs on a two-lane single carriageway road .....	29
Figure 1.5: Stop/go signs on a two-lane single carriageway road .....	30
Figure 1.6: Manually operated stop/go signs and priority signs .....	31
Figure 1.7: Roadworks at a T-junction – traffic control by means of portable traffic signals .....	32
<del>Figure 1.1: Construction highway accesses and haul road crossing points .....</del>	<del>7</del>
<del>Figure 1.2: Haul route crossing .....</del>	<del>22</del>
<del>Figure 1.3: Priority signs on a two-lane single carriageway road .....</del>	<del>26</del>
<del>Figure 1.4: Stop/go signs on a two-lane single carriageway road .....</del>	<del>27</del>
<del>Figure 1.5: Manually operated stop/go signs and priority signs .....</del>	<del>28</del>
<del>Figure 1.6: Roadworks at a T-junction – traffic control by means of portable traffic signals .....</del>	<del>29</del>
<del>Figure 1.1: Construction highway accesses and haul road crossing points .....</del>	<del>5</del>
<del>Figure 1.2: Haul route crossing .....</del>	<del>19</del>
<del>Figure 1.3: Priority signs on a two-lane single carriageway road .....</del>	<del>23</del>
<del>Figure 1.4: Stop/go signs on a two-lane single carriageway road .....</del>	<del>24</del>
<del>Figure 1.5: Manually operated stop/go signs and priority signs .....</del>	<del>25</del>
<del>Figure 1.6: Roadworks at a T-junction – traffic control by means of portable traffic signals .....</del>	<del>26</del>

## Appendices

APPENDIX A : PRELIMINARY ACCESS DESIGNS .....	34
<del>APPENDIX A : PRELIMINARY ACCESS DESIGNS .....</del>	<del>31</del>
<del>APPENDIX A : PRELIMINARY ACCESS DESIGNS .....</del>	<del>28</del>

## Glossary

Term	Meaning
400 kV grid connection cable corridor	The corridor within which the 400 kV grid connection cables will be located.
Applicants	Morgan Offshore Wind Limited (Morgan OWL) and Morecambe Offshore Windfarm Ltd (Morecambe OWL).
Commitment	This term is used interchangeably with mitigation and enhancement measures. The purpose of commitments is to avoid, prevent, reduce or, if possible, offset significant adverse environmental effects. Primary and tertiary commitments are taken into account and embedded within the assessment set out in the ES.
Environmental Statement	The document presenting the results of the Environmental Impact Assessment process.
Generation Assets	The generation assets associated with the Morgan Offshore Wind Project and the Morecambe Offshore Windfarm include the offshore wind turbines, inter-array cables, offshore substation platforms and platform link (interconnector) cables to connect offshore substations.
Haul road	The haul road will provide vehicle access along the onshore export cable corridor and 400 kV grid connection cable corridor off the public highway and will be used where needed throughout the installation of the onshore export cables and 400 kV Grid Connection Cable. The haul road will be 6 m wide (excluding passing places).
Highway Authorities	Lancashire County Council and Blackpool Council as the Local Highway Authority and National Highways as the highway authority for the strategic network collectively referred to as the Highway Authorities.
Landfall	The area in which the offshore export cables make landfall (come on shore) and the transitional area between the offshore cabling and the onshore cabling. This term applies to the entire landfall area at Lytham St. Annes between Mean Low Water Springs and the transition joint bay inclusive of all construction works, including the offshore and onshore cable routes, intertidal working area and landfall compound(s).
Local Highway Authority	A body responsible for the public highways in a particular area of England and Wales, as defined in the Highways Act 1980.
Local Planning Authority	The local government body (e.g., Borough Council, District Council, etc.) responsible for determining planning applications within a specific area.
Mean High Water Springs	The height of mean high water during spring tides in a year.
Mean Low Water Springs	The height of mean low water during spring tides in a year.
Mobilisation period	Period before and after standard construction working hours for deliveries, arrival of construction workers etc.
Morecambe Offshore Windfarm: Transmission Assets	The offshore export cables, landfall and onshore infrastructure required to connect the Morecambe Offshore Windfarm to the National Grid.
Morgan Offshore Wind Project: Transmission Assets	The offshore export cables, landfall and onshore infrastructure required to connect the Morgan Offshore Wind Project to the National Grid.

Term	Meaning
Morgan and Morecambe Offshore Wind Farms: Transmission Assets	The offshore and onshore infrastructure connecting the Morgan Offshore Wind Project and the Morecambe Offshore Windfarm to the national grid. This includes the offshore export cables, landfall site, onshore export cables, onshore substations, 400 kV grid connection cables and associated grid connection infrastructure such as circuit breaker compounds.  Also referred to in this report as the Transmission Assets, for ease of reading.
Onshore export cable corridor	The corridor within which the onshore export cables will be located.
Onshore substation	The onshore substations will include a substation for the Morgan Offshore Wind Project: Transmission Assets and a substation for the Morecambe Offshore Windfarm: Transmission Assets. These will each comprise a compound containing the electrical components for transforming the power supplied from the generation assets to 400 kV and to adjust the power quality and power factor, as required to meet the UK Grid Code for supply to the National Grid.
Outline Construction Traffic Management Plan	A plan establishing vehicle routing and to ensure that vehicles can safely access the onshore elements of Transmission Assets.

## Acronyms

Acronym	Meaning
CoT	Commitment
CTMP	Construction Traffic Management Plan
DCO	Development Consent Order
ES	Environmental Statement
GPS	Global Positioning System
HA	Highway Authority
HAs	Highway Authorities
HAMP	Highways Access Management Plan
HGVs	Heavy Goods Vehicles
LHA	Local Highway Authority
LPA	Local Planning Authority
MfS	Manual for Street (standards)
MHWS	Mean High Water Springs
OCTMP	Outline Construction Traffic Management Plan
OHAMP	Outline Highways Access Management Plan
RSA	Road Safety Audit

## Units

Unit	Description
kV	Kilovolt

# 1 Outline Highway Access Management Plan

## 1.1 Background

### 1.1.1 Introduction

1.1.1.1 This document forms the Outline Highway Access Management Plan (OHAMP) prepared for the Morgan and Morecambe Offshore Wind Farms: Transmission Assets (referred to hereafter as ‘the Transmission Assets’).

### 1.1.2 Project overview

1.1.2.1 Morgan Offshore Wind Limited (Morgan OWL), a joint venture between bp Alternative Energy Investments Ltd. (bp) and Energie Baden-Württemberg AG (EnBW), is developing the Morgan Offshore Wind Project. The Morgan Offshore Wind Project is a proposed wind farm in the east Irish Sea.

1.1.2.2 Morecambe Offshore Windfarm Ltd (Morecambe OWL), a joint venture between Zero-E Offshore Wind S.L.U. (Spain) (a Cobra group company) (Cobra) and Flotation Energy Ltd, is developing the Morecambe Offshore Windfarm, also located in the east Irish Sea.

1.1.2.3 The purpose of the Transmission Assets is to connect the Morgan Offshore Wind Project: Generation Assets and Morecambe Offshore Windfarm: Generation Assets (referred to collectively as the ‘Generation Assets’) to the National Grid.

1.1.2.4 Morgan OWL and Morecambe OWL (the Applicants) are jointly seeking a single consent for their electrically separate transmission assets comprising aligned offshore export cable corridors to landfall and aligned onshore export cable corridors to separate onshore substations, and onward connection to the National Grid at Penwortham, Lancashire.

1.1.2.5 The key components of the Transmission Assets include offshore elements, landfall and onshore elements. Details of the activities and infrastructure associated with the Transmission Assets are set out in Volume 1, Chapter 3: Project Description of the Environmental Statement (ES) (document reference F1.3).

1.1.2.6 This OHAMP has been developed for onshore elements of Transmission Assets, landwards of Mean High Water Springs (MLWS). The elements of the Transmission Assets relevant to this plan are:

- Landfall:
  - landfall site: this is where the offshore export cables are jointed to the onshore export cables via the transition joint bays. This term applies to the entire area between Mean Low Water Springs (MLWS) and the transition joint bays.
- Onshore elements:



- onshore export cables: these export cables will be jointed to the offshore export cables via the transition joint bays at the landfall site, and will bring the electricity generated by the Generation Assets to the onshore substations;
- onshore substations: the two electrically separate onshore substations will contain the components for transforming the power supplied via the onshore export cables up to 400 kV; and
- 400 kV grid connection cables: these export cables will bring the electricity generated by the Generation Assets from the two electrically separate onshore substations to the existing National Grid substation at Penwortham.

1.1.2.7 Full details of the activities and infrastructure associated with the Transmission Assets are set out in Volume 1, Chapter 3: Project Description of the Environmental Statement ([document reference F1.3](#)).

## 1.1.3 Purpose of the Outline Highway Access Management Plan

1.1.3.1 The purpose of this OHAMP is to present the details and preliminary access designs for the accesses and haul road crossings associated with the Transmission Assets. The general arrangement for any street works which may be necessary to facilitate the installation of any site accesses has also been included.

1.1.3.2 The detailed HAMP(s) will set out any updated to the access designs including the location, frontage, general layout, visibility and embedded mitigation measures for points of access to the Transmission Assets.

1.1.3.3 This OHAMP references the following documents:

- Volume 3, Chapter 7: Traffic and transport ([document reference 3.7](#)) of the ES.
- Outline Construction Traffic Management Plan (OCTMP) ([document reference J5](#)).
- Outline Code of Construction Practice (document reference J1).

1.1.3.4 Wider traffic management measure, including information on delivery routes and any potential monitoring are provided in the OCTMP (see document reference J5).

## 1.1.4 Structure of this document

1.1.4.1 This document is set out as follows.

- **Section 1.1** presents an introduction to the OHAMP.
- **Section 1.2** presents outline details for highway accesses.
- **Section 1.3** presents the preliminary access designs and requirements for securing accesses.

- **Section 1.4** presents traffic management relating to accesses and haul road crossings.

## 1.1.5 Implementation of the Outline Highway Access Management Plan

- 1.1.5.1 Following the granting of consent for the Transmission Assets, detailed Highway Access Management Plan(s) (HAMP) will be prepared on behalf of Morgan OWL and/or Morecambe OWL, prior to commencement of the relevant stage of works and will follow the principles established in this OHAMP. The detailed HAMP(s) will require approval by the relevant highways authority.
- 1.1.5.2 The Applicants have committed to implementation of detailed HAMP via the following commitment, CoT23 (see Volume 1, Annex 5.3: Commitments Register, document reference F1.5.3), and is secured by inclusion of Requirement 10 of the draft Development Consent Order (DCO) (document reference C1) Schedules 2A & 2B.
- (10) – (1) No stage of the Project A onshore works may be commenced until for that stage written details (which accord with the outline highway access management plan) of the siting, design, layout, sequencing and timing and any access management measures for any new permanent or temporary means of access to a highway to be used by vehicular traffic, or any alteration to an existing means of access to a highway, have been submitted to and approved by the highway authority.*
- (2) The highway access for that stage must be constructed or altered, and the works described in paragraph (1) in relation to access management measures carried out, in accordance with the approved details before the relevant highway accesses are brought into use for the purposes of the authorised project.*
- (3) Onshore site preparation works must be carried out in accordance with the applicable details set out in the outline construction traffic management plan and the outline highway access management plan.*
- 1.1.5.3 The Transmission Assets may adopt a staged approach to the approval of DCO requirements enabling requirements to be approved in part or in whole, prior to the commencement of the relevant stage of works according to whether a staged approach is to be taken to the delivery of the each of the offshore wind farms.
- 1.1.5.4 For onshore and intertidal works this approach will be governed by the inclusion of Requirement 3 within the draft DCO, which requires notification to be submitted to the relevant planning authority/authorities detailing whether Project A or Project B relevant works will be constructed in a single stage; or in two or more stages to be approved prior to the commencement of the authorised development.
- 1.1.5.5 Pre-construction and/or site preparation activities may be undertaken prior to the commencement of construction. These activities would comprise the following, in accordance with the definition of ‘onshore site

preparation works' as defined by the draft DCO and deemed marine licenses (Document Reference C1) and Volume 1, Chapter 3: Project Description ([document reference 1.3\) of the ES:](#)

- site clearance;
- demolition;
- early planting of landscaping works
- archaeological investigations;
- environmental surveys;
- ecological mitigation;
- biodiversity benefit works;
- removal of hedgerows and trees;
- surveys and investigations for the purpose of assessing ground conditions;
- remedial work in respect of contamination or other adverse ground conditions;
- diversion and laying of utilities and services;
- site security works;
- the erection of temporary means of enclosure;
- the erection of temporary hard standing;
- the erection of welfare facilities and compounds for welfare facilities;
- creation of site accesses;
- onshore substation preparatory ground works; and
- temporary display of site notices or advertisements.

## 1.2 Highway accesses

- 1.2.1.1 This OHAMP includes temporary construction accesses onto the public highway and haul road crossings of the public highway as presented on **Figure 1.1**.
- 1.2.1.2 The construction accesses provide for both ingress and egress to and from the public highway.
- 1.2.1.3 Access points assigned as 'haul road crossing only points' will only permit construction traffic to cross from one side of the existing public highway to the other from one part of the haul road to another. No construction ingress or egress to or from the public highway would be permitted at these points.
- 1.2.1.4 There are some highway access points presented on **Figure 1.1** that also act as haul road crossing points. These will provide for both ingress and egress to and from the public highway and will also be used to cross the public highway from one part of the haul road to another.

1.2.1.5 The onshore substation temporary accesses will also become permanent access points to enable ongoing access for operation and maintenance phases.

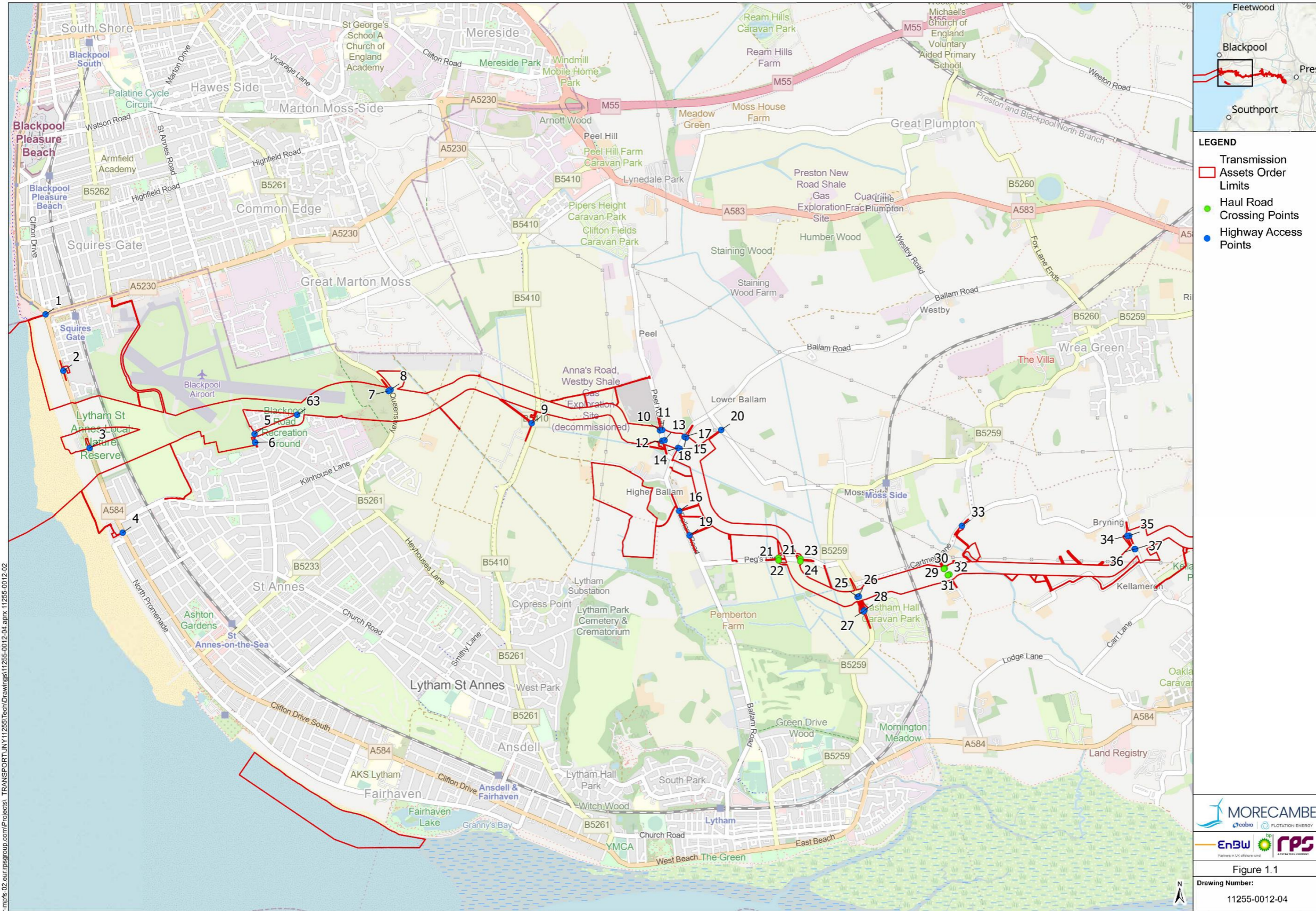

**LEGEND**

- Transmission Assets Order Limits
- Haul Road Crossing Points
- Highway Access Points

**MORECAMBE**  
cobro FLOTATION ENERGY

**EnBW** **rps**  
Partners in UK offshore wind

**Figure 1.1**  
Drawing Number:  
11255-0012-04

Project Name:  
MORGAN AND MORECAMBE OFFSHORE WIND FARMS: TRANSMISSION ASSETS

Drawing Title:  
CONSTRUCTION HIGHWAY ACCESS AND HAUL ROAD CROSSING POINTS (WEST)

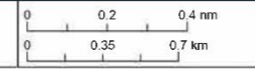

Geodetic Information:  
Datum: OSGB 1936  
Projection: British National Grid  
Scale@379mmx231mm: 1:28,000

Data Sources: Client, The Crown Estate, MMO, NRW, ScotGov, MarineRegions.org

© Crown copyright. All rights reserved. 2024 License number 100031673.  
Service layer credits: Esri UK, Esri, TomTom, Garmin, Foursquare, FMO, METI/NASA, USGS, Map data © OpenStreetMap contributors, Microsoft, Facebook, Inc. and its affiliates, Esri Community Maps contributors, Map layer by Esri, Esri, CGIAR, USGS

VER	DATE	DETAILS	BY	CHECK
00	03/12/24	FINAL	JM	LS

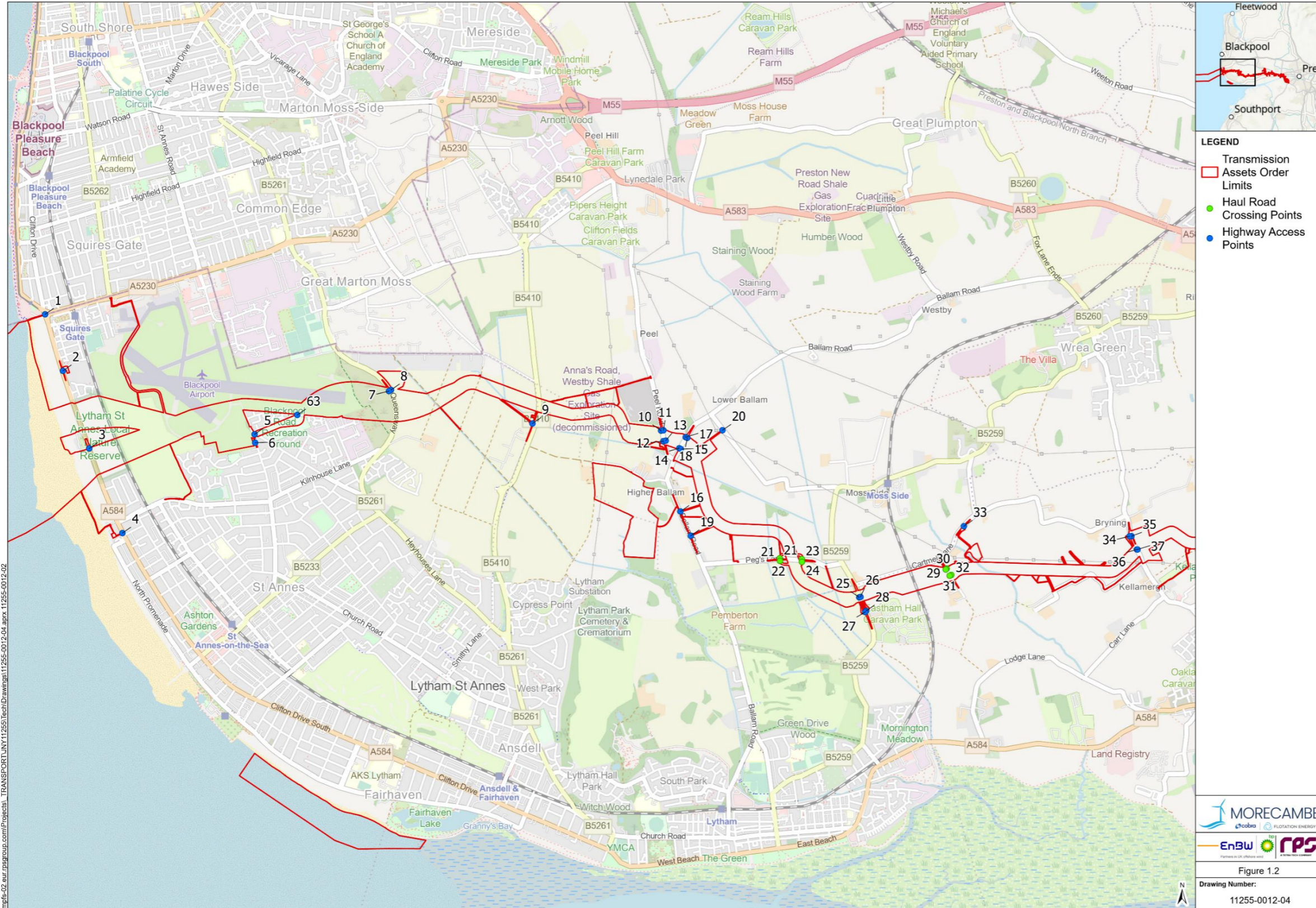

Path: P:\eur\mpfs-02\_eur\_rpsgroup.com\Projects\_TRANSPORT\UNY11255\TechDrawings\11255-0012-04.aprx.11255-0012-02

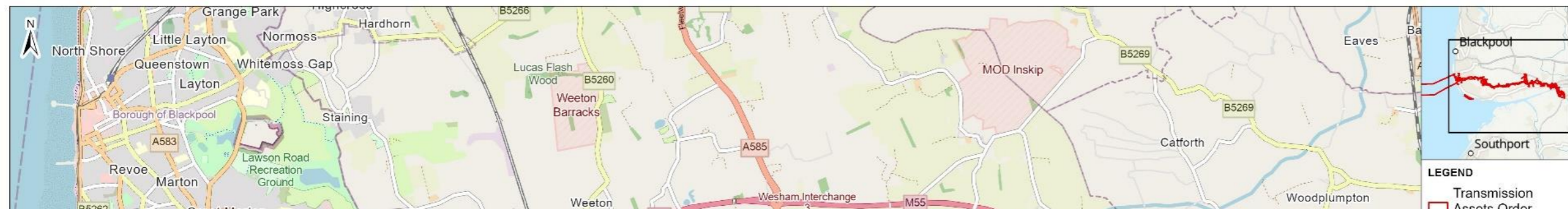

[Figure 1.1: Construction highway accesses and haul road crossing points \(West\)](#)

~~Figure 1.1: Construction highway accesses and haul road crossing points~~

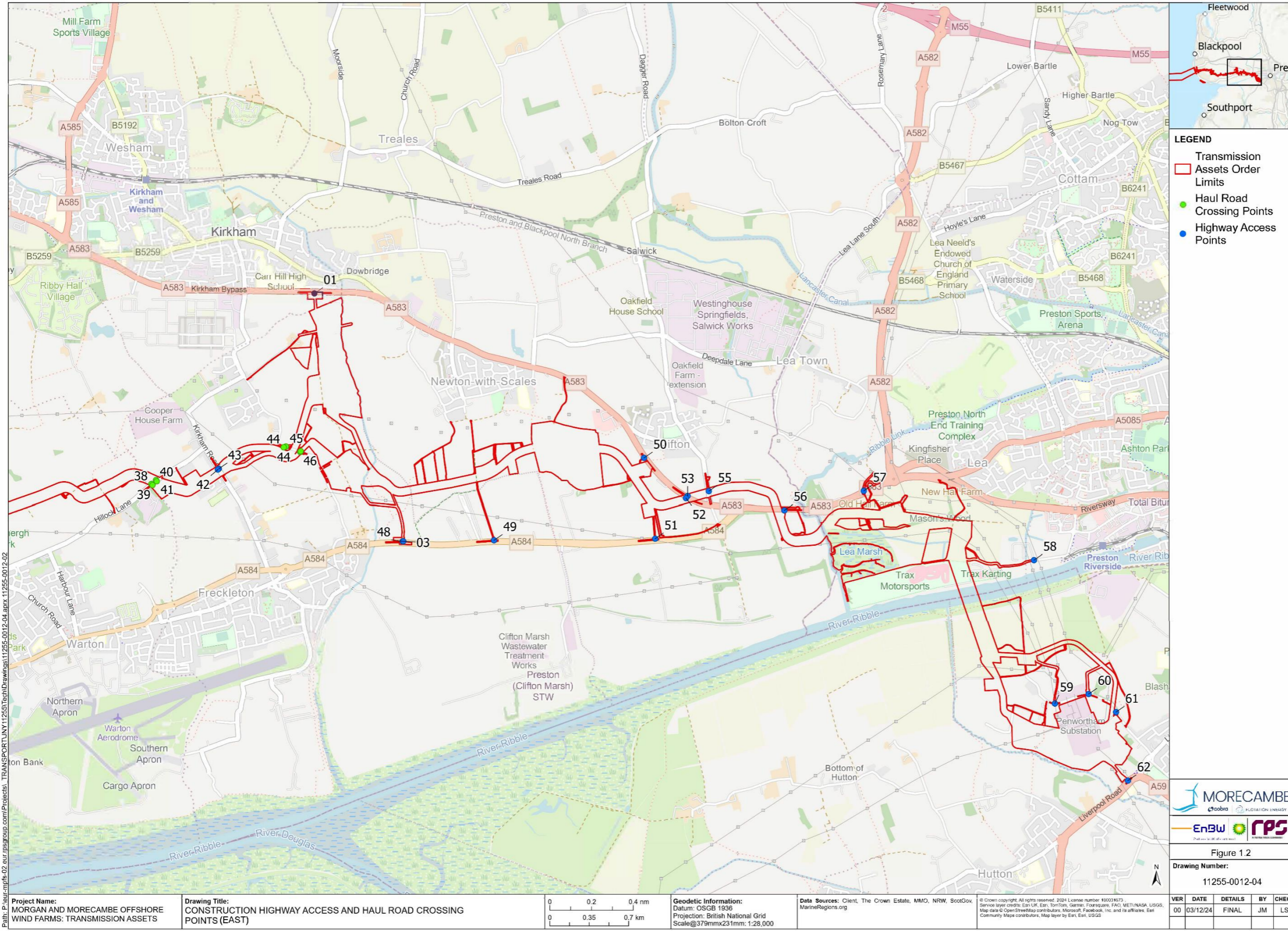



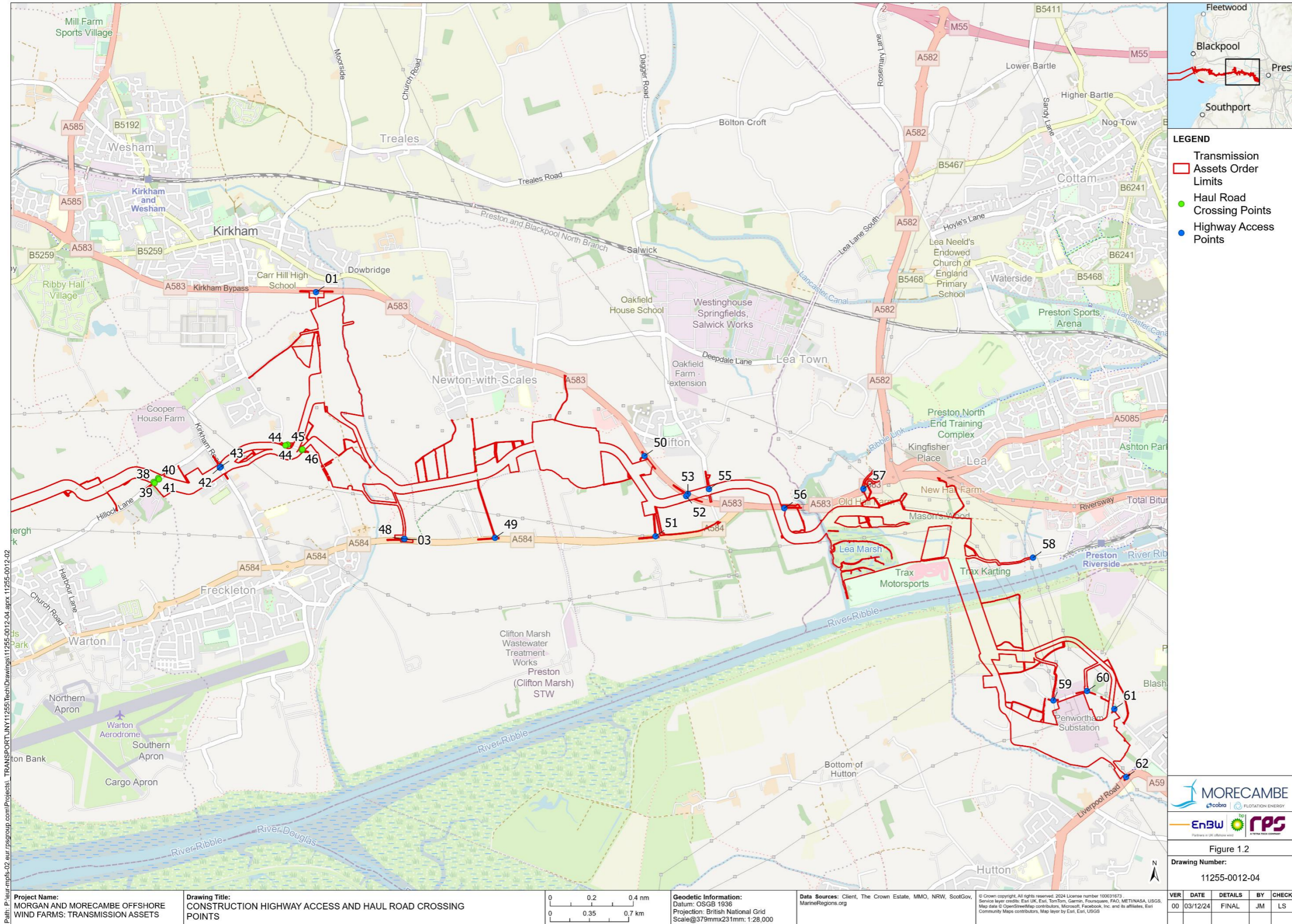

**Figure 1.2: Construction highway accesses and haul road crossing points (East)** **Figure 1.1: Construction highway accesses and haul road crossing points**

**Construction highway accesses and haul road crossing points**

## 1.3 Access designs

1.3.1.1 Access designs of the accesses and crossings are included at **Appendix A**.

1.3.1.2 **Table 1.1** ~~Table 1.1~~ presents the construction accesses and crossings, the operation and maintenance accesses for which construction works are required and the preliminary design drawing numbers related to each. Should changes to these access designs need to be made post-consent, including the movement of the location of the access points within the Order Limits, these will be agreed in accordance with Requirements 10 of the DCO.

~~1.3.1.2~~ 1.3.1.3 Please note that the highway access points on directly correspond to the access ID in **Table 1.1** ~~Table 1.1~~ **Table 1.1** ~~Table 1.1~~ and **Appendix A** (i.e., access point 1 is equivalent to access ID A1).

**Table 1.1: Preliminary access design summary**

Access ID	Road name	Access type	Posted Speed Limit (PSL) or measured speed (mph)	Required visibility splay distance for the PSL or measured speed (*) **	Drawing number	Notes
A1	Starr Gate	Existing Access	30 (PSL)	N/A	PC1165-RHD-ZZ-XX-SW-TP-0066	N/A
A2	Clifton Dr N	Existing Access	30 (PSL)	90m	PC1165-RHD-ZZ-XX-SW-TP-0149 & 0150	N/A
A3	A584	Existing Access	33.5 (Measured Speed)	90m	PC1165-RHD-ZZ-XX-SW-TP-0001 & 0050	N/A
A4	A584, opp. Norwood Road	Existing Access	30 (PSL)	90m	PC1165-RHD-ZZ-XX-SW-TP-0074 & 0068	N/A
A5	Blackpool Road N/ Leach Lane	New Access (Existing pedestrian access)	20 (PSL)	43m (MfS)	PC1165-RHD-ZZ-XX-SW-TP-0147 & 0148	N/A
A6	Leach Lane	New Access	20 (PSL)	70m	PC1165-RHD-ZZ-XX-SW-TP-0002 & 0051	N/A
A7 & A8	B5261	New Access	40 (PSL)	120m	PC1165-RHD-ZZ-XX-SW-TP-0004 & 0052	N/A
	B5261	New Access	40 (PSL)	120m		N/A
A10 & A11	Peel Road	New Access	40 (PSL)	120m	PC1165-RHD-ZZ-XX-SW-TP-0084,	N/A
		New Access	40 (PSL)	120m		

Access ID	Road name	Access type	Posted Speed Limit (PSL) or measured speed (mph)	Required visibility splay distance for the PSL or measured speed (*) **	Drawing number	Notes
A12 & A13		New Access	40 (PSL)	120m	PC1165-RHD-ZZ-XX-SW-TP-0085	
		New Access	40 (PSL)	120m	PC1165-RHD-ZZ-XX-SW-TP-0086, PC1165-RHD-ZZ-XX-SW-TP-0087	
A14 & A15	Ballam Road	New Access	40 (PSL)	120m	PC1165-RHD-ZZ-XX-SW-TP-0088, PC1165-RHD-ZZ-XX-SW-TP-0089	N/A
		New Access	40 (PSL)	120m		
A16	Ballam Road	New Access	44.7 (Measured Speed)	160m	PC1165-RHD-ZZ-XX-SW-TP-0005 & 0053	N/A
A17 & A18	Ballam Road	New Access	40 (PSL)	120m	PC1165-RHD-ZZ-XX-SW-TP-0090, PC1165-RHD-ZZ-XX-SW-TP-0091	N/A
		New Access	40 (PSL)	120m		
A19	Ballam Road	New Access	44.7 (Measured Speed)	160m	PC1165-RHD-ZZ-XX-SW-TP-0006 & 0054	N/A
A21 & A22	Peg's Lane	New Crossing	60 (PSL)	215 (Reduced to 120m)	PC1165-RHD-ZZ-XX-SW-TP-0094	The posted speed limit on Peg's Lane is 60mph. It is considered however that vehicles would
	Peg's Lane	New Crossing	60 (PSL)	215 (Reduced to 120m)		

Access ID	Road name	Access type	Posted Speed Limit (PSL) or measured speed (mph)	Required visibility splay distance for the PSL or measured speed (*) **	Drawing number	Notes
A23 & A24	Peg's Lane	New Crossing	60 (PSL)	215 (Reduced to 120m)	PC1165-RHD-ZZ-XX-SW-TP-0093	<p>not be travelling at the posted speed limit due to the narrow nature of the existing road. It is assumed that vehicles will be traveling at no more than 40mph on this road. Therefore, a visibility splay of 120m, equivalent to a design speed of 40mph, is proposed.</p> <p>A temporary reduction in the speed limit would be adopted at this access.</p>
	Peg's Lane	New Crossing	60 (PSL)	215 (Reduced to 120m)		
A25 & A26	B5259	New Access	48.3 (Measured Speed)	160m	PC1165-RHD-ZZ-XX-SW-TP-0011 & 0056	N/A
	B5259	New Access	48.3 (Measured Speed)	160m		
A27 & A28	B5259	New Access	48.3 (Measured Speed)	160m	PC1165-RHD-ZZ-XX-SW-TP-0013 & 0057	N/A
	B5259	New Access	48.3 (Measured Speed)	160m		

Access ID	Road name	Access type	Posted Speed Limit (PSL) or measured speed (mph)	Required visibility splay distance for the PSL or measured speed (*) **	Drawing number	Notes
A29 & A30	Huck Lane	New Crossing	60 (PSL)	215 (Reduced to 120m)	PC1165-RHD-ZZ-XX-SW-TP-0044 & 0129	The posted speed limit on Huck Lane is 60mph. It is considered however that vehicles would not be travelling at the posted speed limit due to the single-track nature of the existing road. It is assumed that vehicles will be traveling at no more than 40mph on this road. Therefore, a visibility splay of 120m, equivalent to a design speed of 40mph, is proposed.
	Huck Lane	New Crossing	60 (PSL)	215 (Reduced to 120m)		
A31 & A32	Huck Lane	New Crossing	60 (PSL)	215 (Reduced to 120m)	PC1165-RHD-ZZ-XX-SW-TP-0045 & 0130	A temporary reduction in the speed limit would be adopted at this access.
	Huck Lane	New Crossing	60 (PSL)	215 (Reduced to 120m)		
A33	Cartmell Lane	New Access	60 (PSL)	215 (Reduced to 90m)	PC1165-RHD-ZZ-XX-SW-TP-0138 & 0139	The posted speed limit on Cartmell Lane is 60mph. It is considered however that vehicles would not be travelling at the

Access ID	Road name	Access type	Posted Speed Limit (PSL) or measured speed (mph)	Required visibility splay distance for the PSL or measured speed (*) **	Drawing number	Notes
						<p>posted speed limit due to the narrow nature of the existing road.</p> <p>It is assumed that vehicles will be traveling at no more than 30mph on this road. Therefore, a visibility splay of 90m, equivalent to a design speed of 30mph is proposed.</p> <p>A temporary reduction in the speed limit would be adopted at this access.</p>
A34 & A35	Bryning Lane	New Access	47.5 (Measured Speed)	160 (Reduced to 120m)	PC1165-RHD-ZZ-XX-SW-TP-0015 & 0058	<p>The posted speed limit on Bryning Lane is 60mph, but the measured speed at this location is 47.5mph. This speed requires a visibility splay of 160m. However, a 160m visibility splay at this location would</p>
	Bryning Lane	New Access	47.5 (Measured Speed)	160 (Reduced to 120m)		
A36 & A37	Bryning Lane	New Access	47.5 (Measured Speed)	160 (Reduced to 120m)	PC1165-RHD-ZZ-XX-SW-TP-0017 & 0059	
	Bryning Lane	New Access	47.5 (Measured Speed)	160 (Reduced to 120m)		



Access ID	Road name	Access type	Posted Speed Limit (PSL) or measured speed (mph)	Required visibility splay distance for the PSL or measured speed (*) **	Drawing number	Notes
						<p>interfere with the building and third-party land to the north. To avoid this, a visibility splay of 120m, equivalent to a design speed of 40mph, is proposed.</p> <p>A temporary reduction in the speed limit would be adopted at this access.</p>
A38 & A39	Hillock Lane	New Crossing	60 (PSL)	215 (Reduced to 120m)	PC1165-RHD-ZZ-XX-SW-TP-0095	<p>The posted speed limit on Hillock Lane is 60mph. It is considered however that vehicles would not be travelling at the posted speed limit due to the narrow nature of the existing road. It is assumed that vehicles will be traveling at no more than 40mph on this road. Therefore, a visibility splay of 120m, equivalent to a</p>
	Hillock Lane	New Crossing	60 (PSL)	215 (Reduced to 120m)		

Access ID	Road name	Access type	Posted Speed Limit (PSL) or measured speed (mph)	Required visibility splay distance for the PSL or measured speed (*) **	Drawing number	Notes
						<p>design speed of 40mph, is proposed.</p> <p>A temporary reduction in the speed limit would be adopted at this access.</p>
A40 & A41	Hillock Lane	New Crossing	60 (PSL)	215 (Reduced to 120m)	PC1165-RHD-ZZ-XX-SW-TP-0019	<p>The posted speed limit on Hillock Lane is 60mph. It is considered however that vehicles would not be travelling at the posted speed limit due to the single-track nature of the existing road. It is assumed that vehicles will be traveling at no more than 40mph on this road. Therefore, a visibility splay of 120m, equivalent to a design speed of 40mph, is proposed.</p> <p>A temporary reduction in the speed limit</p>
	Hillock Lane	New Crossing	60 (PSL)	215 (Reduced to 120m)		

Access ID	Road name	Access type	Posted Speed Limit (PSL) or measured speed (mph)	Required visibility splay distance for the PSL or measured speed (*) **	Drawing number	Notes
						would be adopted at this access.
A42 & A43	Kirkham Road	New Access	40 (PSL)	120m	PC1165-RHD-ZZ-XX-SW-TP-0022 & 0060	N/A
	Kirkham Road	New Access	40 (PSL)	120m		
A44 & A45	Lower Lane	New Crossing	41.4 (Measured Speed)	120 (Reduced to 70m)	PC1165-RHD-ZZ-XX-SW-TP-0023	The posted speed limit on Lower Lane is 60mph and measured speeds to the north of this location are 41.4mph. This speed requires a visibility splay of 120m. However, existing bends and woodland on Lower Lane prevent achieving a 120m visibility splay. Given the existing bends and narrow nature of the road it is anticipated that vehicles will travel at lower speeds than the posted speed limit and measured speeds to the north (where the road is straighter).
	Lower Lane	New Crossing	41.4 (Measured Speed)	120 (Reduced to 70m)		
A46 & A47	Lower Lane	New Crossing	41.4 (Measured Speed)	120 (Reduced to 70m)	PC1165-RHD-ZZ-XX-SW-TP-0024	
	Lower Lane	New Crossing	41.4 (Measured Speed)	120 (Reduced to 70m)		

Access ID	Road name	Access type	Posted Speed Limit (PSL) or measured speed (mph)	Required visibility splay distance for the PSL or measured speed (*) **	Drawing number	Notes
						<p>It is assumed that vehicles will be traveling at less than 30mph on this road. Therefore, a visibility splay of 70m, equivalent to a design speed of 30mph, is proposed.</p> <p>A temporary reduction in the speed limit would be adopted at this access.</p>
A48 (incorporating A03)	A584/Preston New Road	New Access	50 (PSL)	160m	PC1165-RHD-ZZ-XX-SW-TP-0107, 0108 and 0121	Transformer consideration for A03 only.
A49	A584/Preston New Road	New Access	50(PSL)	160m	PC1165-RHD-ZZ-XX-SW-TP-0126 & 0127	N/A
A50	A583	New Access	50 (PSL)	160m	PC1165-RHD-ZZ-XX-SW-TP-0025 & 0061	N/A
A51	A584	New Access	50.2 (Measured Speed)	160m	PC1165-RHD-ZZ-XX-SW-TP-0026 & 0062	N/A

Access ID	Road name	Access type	Posted Speed Limit (PSL) or measured speed (mph)	Required visibility splay distance for the PSL or measured speed (*) **	Drawing number	Notes
A52 & A53	A583	New Access	50 (PSL)	160m	PC1165-RHD-ZZ-XX-SW-TP-0028 & PC1165-RHD-ZZ-XX-SW-TP-0063	N/A
	A583	New Access	50 (PSL)	160m		
A55	Lodge Lane	New Access	50 (PSL)	160m	PC1165-RHD-ZZ-XX-SW-TP-0029, PC1165-RHD-ZZ-XX-SW-TP-0064,	N/A
A56	A583/Preston New Road	New Access	50(PSL)	160m	PC1165-RHD-ZZ-XX-SW-TP-0113 & 0114	N/A
A57	A583/Blackpool Road	Existing Access	50 (PSL)	160m	PC1165-RHD-ZZ-XX-SW-TP-0124 & 0125	N/A
A58	Wallend Road	New Access	20 (PSL)	43m (MfS)	PC1165-RHD-ZZ-XX-SW-TP-0115 & 0116	N/A
A59	Howick Cross Lane	Existing Access	30 (PSL)	43m (MfS)	PC1165-RHD-ZZ-XX-SW-TP-0134 & 0135	N/A
A60	Howick Cross Lane	Existing private access + proposed widening	30 (PSL)	43m (MfS)	PC1165-RHD-ZZ-XX-SW-TP-0136 & 0137	N/A

Access ID	Road name	Access type	Posted Speed Limit (PSL) or measured speed (mph)	Required visibility splay distance for the PSL or measured speed (*) **	Drawing number	Notes
A61	Howick Cross Lane	Existing Access	30 (PSL)	43m (MfS)	PC1165-RHD-ZZ-XX-SW-TP-0154 & 0155	N/A
A62	A59/Liverpool Road	Existing Access	40 (PSL)	120m	PC1165-RHD-ZZ-XX-SW-TP-0132 & 0133	N/A
A63	The Hamlet	New Access	20 (PSL)	43m (MfS)	PC1165-RHD-ZZ-XX-SW-TP-0152 & 0153	N/A
A01	A583/Kirkham Bypass	New Access	50 (PSL)	160m	PC1165-RHD-ZZ-XX-SW-TP-0103, 0104 and 0119	N/A
A02	Lower Lane (West of Morecambe Substation)	New Access	60 (PSL)	215 (Reduced to 120m)	PC1165-RHD-ZZ-XX-SW-TP-0142 & 0143	<p>The posted speed limit on Lower Lane is 60mph. It is considered however that vehicles would not be travelling at the posted speed limit due to the narrow nature of the existing road.</p> <p>It is assumed that vehicles will be traveling at no more than 40mph on this road. Therefore, a</p>

Access ID	Road name	Access type	Posted Speed Limit (PSL) or measured speed (mph)	Required visibility splay distance for the PSL or measured speed (*) **	Drawing number	Notes
						visibility splay of 120m, equivalent to a design speed of 40mph, is proposed.

\*Number in brackets represents where a visibility splay less than required for the posted speed limit has been assumed. Further explanation of the rationale for this adopted approach is provided within the notes column.

\*\*Visibility splays have been informed by the requirement of the Design Manual for Roads and Bridges unless noted otherwise by (MfS) where Manual for Street standards have been adopted.

## 1.3.2 Haul road crossings of public highways

1.3.2.1 Where the haul roads cross the public highway, traffic management would be used to ensure the safety of highway users and haul road vehicles. An example of a haul road crossing using traffic signals is set out on [Figure 1.3](#)~~Figure 1.3~~~~Figure 1.2~~~~Figure 1.2~~, extracted from The Traffic Signs Manual, Chapter 8, Part 1, Traffic Safety Measures and Signs for Road Works and Temporary Situations, Department for Transport/Highways Agency, 2009.

1.3.2.2 If the crossing is not signal controlled, the variant of diagram 511 (as shown on [Figure 1.3](#)~~Figure 1.3~~~~Figure 1.2~~~~Figure 1.2~~) 'heavy plant crossing' should be placed in advance of the crossing place.

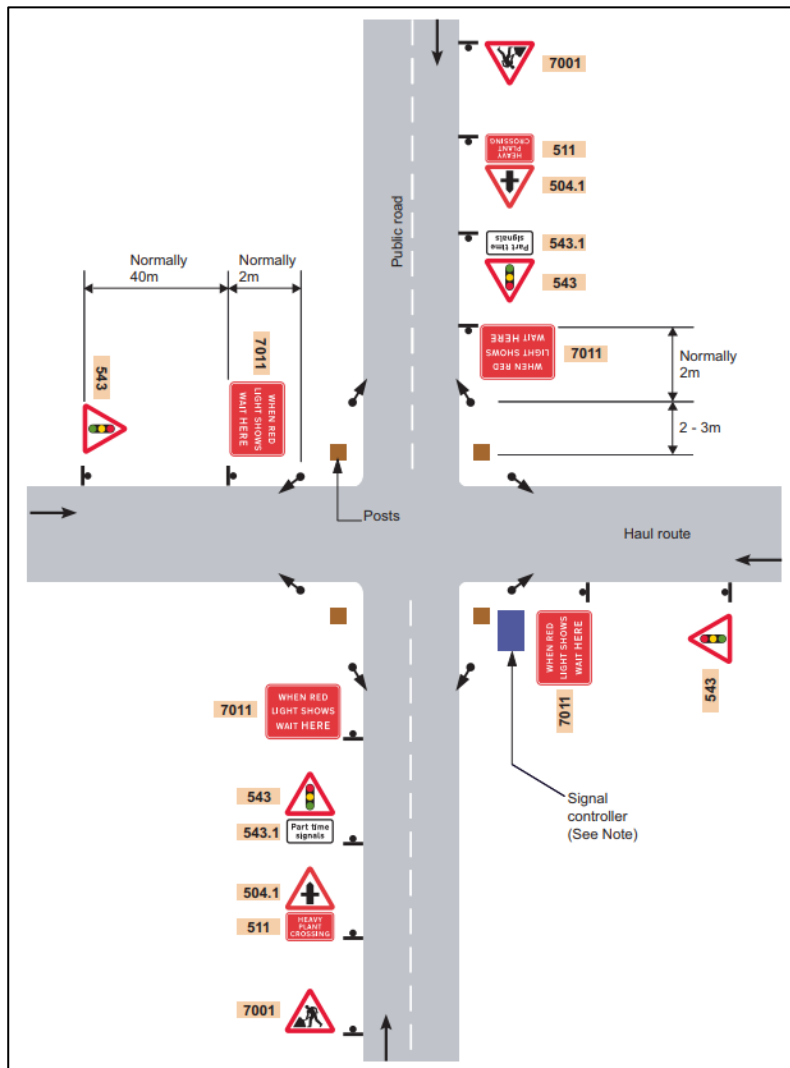

**Figure 1.3**~~1.2~~: Haul route crossing



### 1.3.3 Road safety

- 1.3.3.1 The following mitigation measures have been developed to reduce the risk to the travelling public and construction personnel and are applied to accesses and crossings, where applicable.
- Temporary direction and warning signs to advise of turning vehicles would be provided for all accesses. This signage would highlight the proposed accesses to construction personnel traffic to avoid late breaking manoeuvres and highlight to the travelling public the potential for turning vehicles.
  - Temporary warning signs to advise of crossing vehicles would be provided for all crossings. This signage would highlight to the travelling public the potential for crossing vehicles.
  - Where applicable, crossings constructed to prevent access from the highway, ensuring vehicles do not attempt to access or egress these locations.
  - All priority controlled accesses and crossings provided with appropriate visibility splays to allow vehicles to safely ingress and egress. Visibility splays identified within the Order Limits will be maintained by the Principal Contractor(s) for the duration of use of the access.
  - All accesses onto and crossings over the public highway to incorporate a bound (concrete or asphalt) surface to prevent dust and dirt being tracked on to the highway.
  - Temporary reduction in the existing speed limit in the vicinity of all accesses and crossings to be considered to reduce the speed of vehicles in the vicinity of these locations. Any such traffic management would be agreed prior to construction.
  - Where appropriate a banksman will be situated at an access to assist construction vehicles to ingress and egress.

### 1.3.4 Technical approval

- 1.3.4.1 Once Principal Contractor(s) have been appointed, any updates to the detailed designs for the accesses, crossings and any associated traffic management measures will be submitted to the relevant highways authority, in accordance with DCO (document reference: C1).
- 1.3.4.2 The technical approval process will include submission of any updated drawings, showing information, including any relevant access and crossing arrangements, drainage, lighting, signing, and standard construction details.
- 1.3.4.3 The accesses highlighted within this OHAMP are temporary, save for those to the permanent access points for each of the onshore substations, and following completion of construction would be reinstated to their former state.

1.3.4.4 All temporary speed limit restrictions associated with temporary accesses will be implemented by the relevant highways authority following an application by the Applicant(s) or Principal Contractor(s).

### 1.3.5 Road safety audit

1.3.5.1 The technical approval process will comply with the Road Safety Audit (RSA) process (as outlined within the Design for Manual Roads and Bridges GG 119, National Highways, January 2022) for all accesses and crossings. The RSA process comprises of a systematic process for the independent safety review of highway schemes. The purpose of the RSA process is to minimise the future occurrences and severity of collisions once a scheme has been built.

## 1.4 Traffic management for temporary highway access points

### 1.4.1 Overview

1.4.1.1 Where applicable, temporary traffic management will be implemented at each of the accesses and crossings to maintain highway safety and to ensure minimal delays to existing road users.

1.4.1.2 In addition, to minimise the impacts of construction traffic on the wider highway associated with the construction of the accesses and crossings, wider control measures proportionate to the scale of the proposed works are detailed below. Details of traffic management not related to temporary access points, and therefore related to wider traffic management will be included in the detailed Construction Traffic Management Plan(s) (see document reference J5, for the Outline Construction Traffic Management Plan).

### 1.4.2 Road works

1.4.2.1 Traffic management measures may be required for various reasons and the type of traffic management measure to adopt will depend upon the location on the highway, the nature and level of traffic on the highway, what is served by the highway, and the alternative routes available.

1.4.2.2 Traffic management measures that could be used would include stopping traffic on the highway, this could be via temporary portable signals or via manually operated stop/go signs.

1.4.2.3 Shuttle working is where one direction of travel receives priority over the other. This could be via temporary portable signals or via give way signs.

1.4.2.4 Some example layouts of these traffic management measures and features are shown on [Figure 1.4](#) [Figure 1.4](#) [Figure 1.3](#) [Figure 1.3](#) to [Figure 1.7](#) [Figure 1.7](#) [Figure 1.6](#) [Figure 1.6](#). These examples are extracted from The Traffic Signs Manual, Chapter 8, Part 1, Traffic Safety Measures and Signs for Road Works and Temporary Situations, Department for Transport/Welsh Government/Transport Scotland/

Department for Infrastructure, 2009. The extracts are generic in nature, and they are not designed to be specific to any particular location or circumstance but designed to be implemented in accordance with the advice contained within the document.

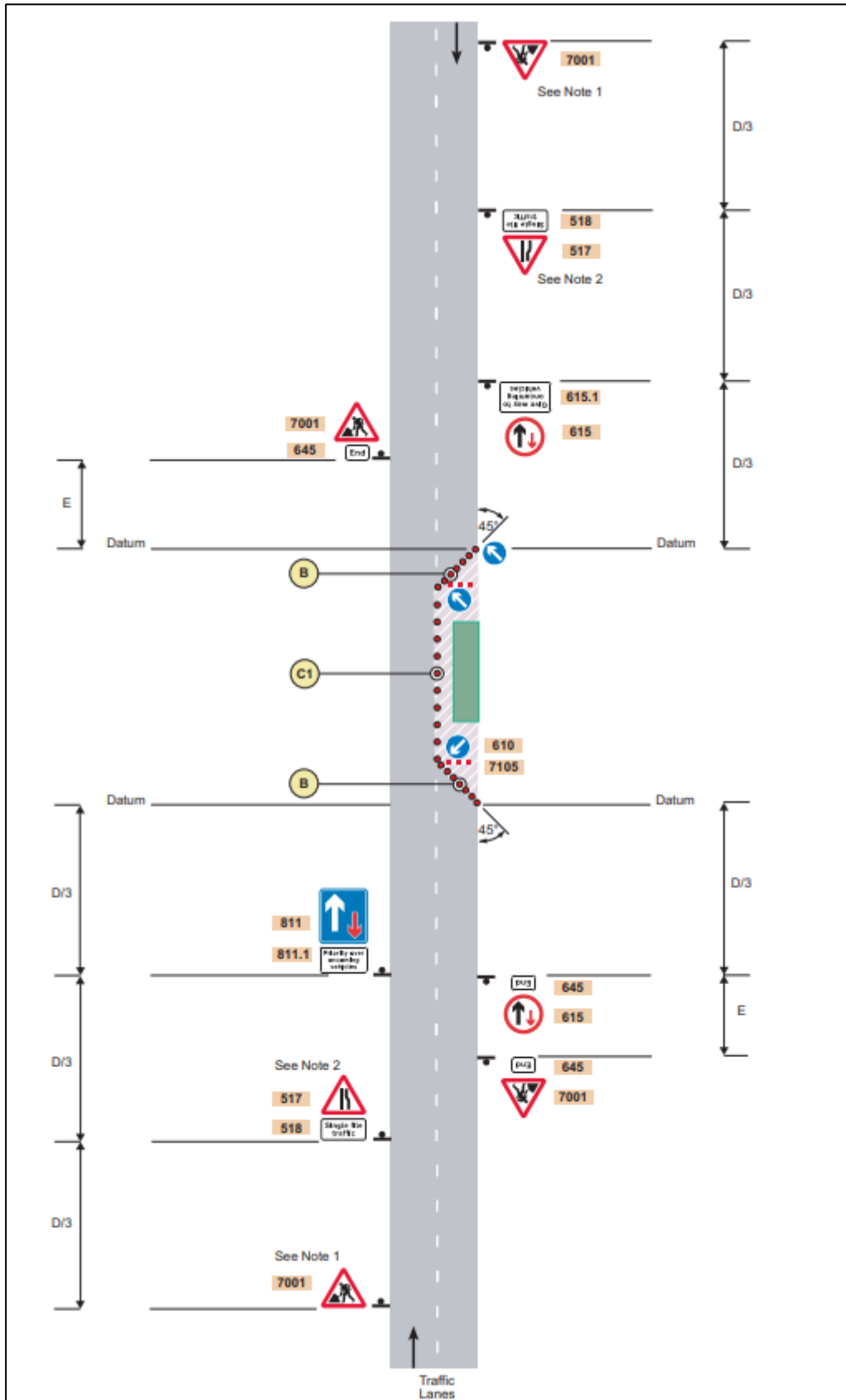

**Figure 1.4.1.3: Priority signs on a two-lane single carriageway road**

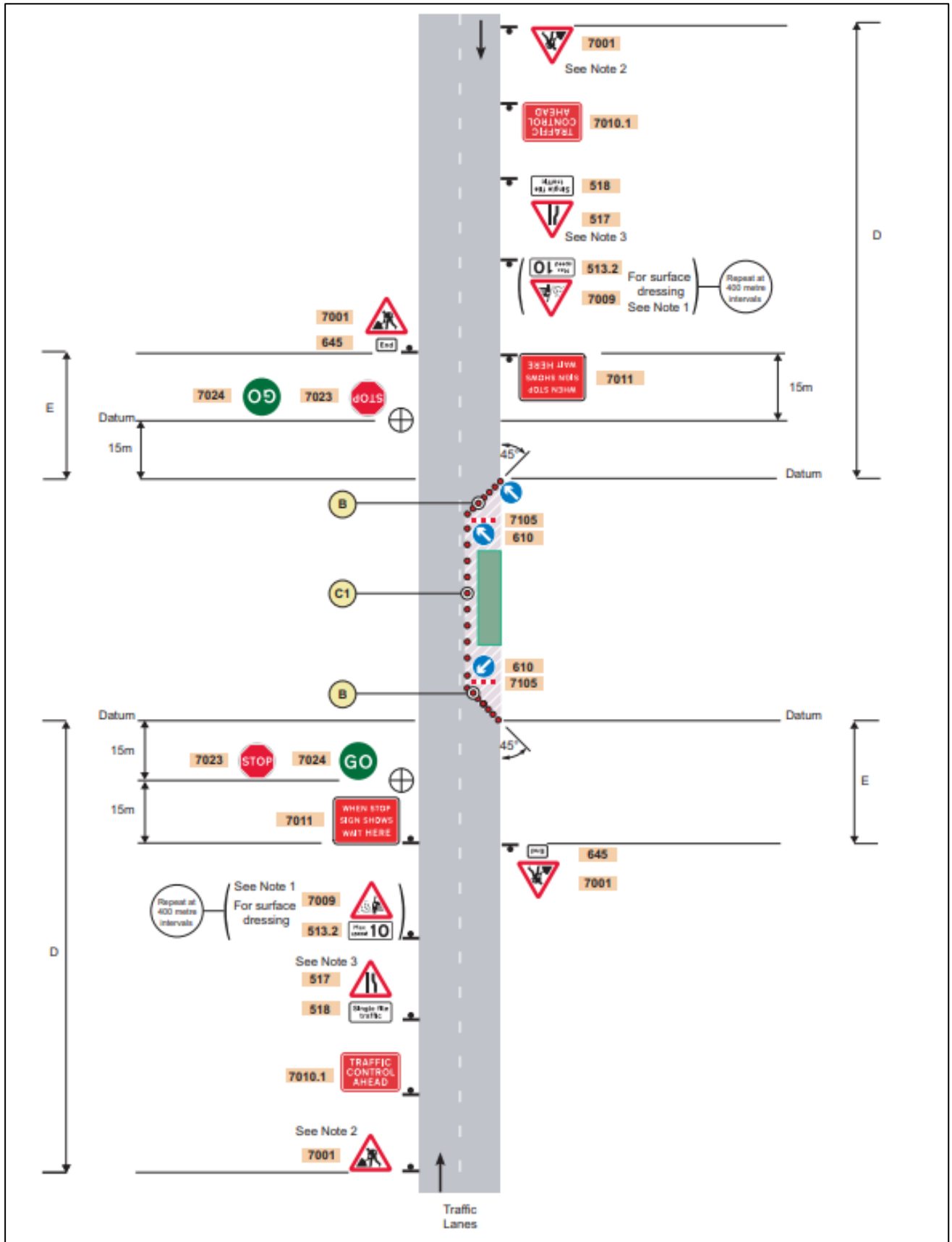

**Figure 1.51.4:** Stop/go signs on a two-lane single carriageway road



Figure 1.6.1-5: Manually operated stop/go signs and priority signs

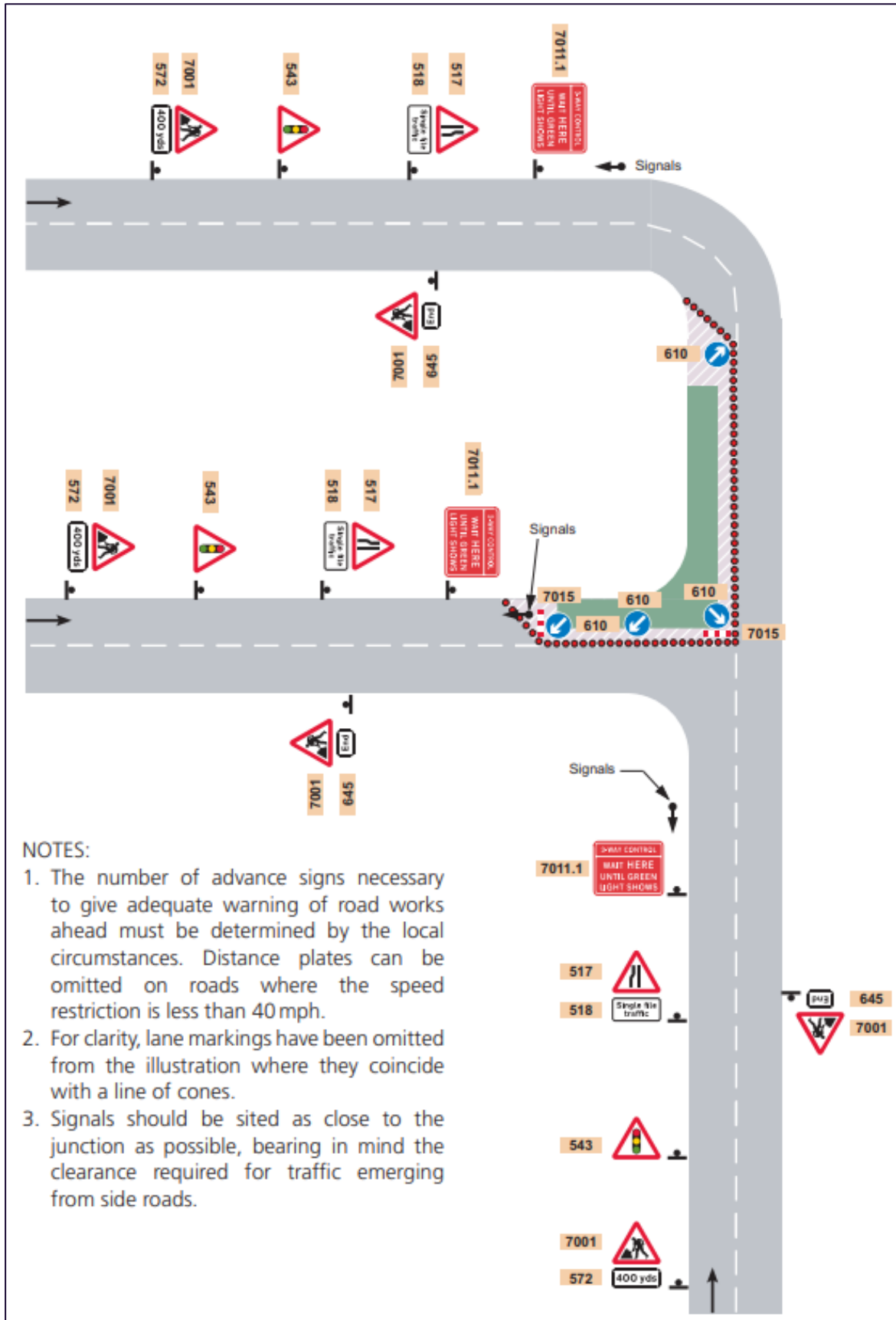

**Figure 1.7.1-6: Roadworks at a T-junction – traffic control by means of portable traffic signals.**

## 1.5 References

Department for Transport/Welsh Government/Transport Scotland/Department for Infrastructure (2009) Traffic Signs Manual Chapter 8, Traffic Safety Measures and Signs for Road Works and Temporary Situations Part 1: Design. Available at <https://assets.publishing.service.gov.uk/media/5a74adeaed915d7ab83b5ab2/traffic-signs-manual-chapter-08-part-01.pdf>. Accessed December 2023.

Department for Transport/ Communities and Local Government/Welsh Assembly Government (2007) Manual for Streets. Available at: [https://assets.publishing.service.gov.uk/government/uploads/system/uploads/attachment\\_data/file/341513/pdfmanforstreets.pdf#:~:text=A%20comprehensive%20guide%20for%20designing](https://assets.publishing.service.gov.uk/government/uploads/system/uploads/attachment_data/file/341513/pdfmanforstreets.pdf#:~:text=A%20comprehensive%20guide%20for%20designing). Accessed December 2023.

Highways England/Transport Scotland/Welsh Government/Department for Infrastructure (2020). Design Manual for Roads and Bridges (DMRB) CD 123 - Geometric design of at-grade priority and signal controlled junctions. Available at

[REDACTED]  
[REDACTED]  
[REDACTED]  
[REDACTED]  
[REDACTED]  
[REDACTED] Accessed December 2023.

Highways England/Transport Scotland/Welsh Government/Department for Infrastructure (2020). Design Manual for Roads and Bridges (DMRB) GG119–Road Safety Audit. Available at

[REDACTED]  
[REDACTED] Accessed December 2023

The Chartered Institute of Highways and Transportation (2010) Manual for Streets 2 – Wider Application of the Principles. Available at

[REDACTED] Accessed December 2023



## Appendix A: Preliminary access designs



**NOTES**  
 1. Do not scale from this drawing, all dimensions are in metres unless noted otherwise.  
 2. This drawing has been based upon Ordnance Survey Maps and Royal HaskoningDHV can not guarantee the accuracy of data.

**KEY**

	EXISTING ARRANGEMENT
	MORGAN AND MORECAMBE ORDER LIMITS

**VEHICLE TRACKING**

Max Legal Length (UK) Articulated Vehicle (16.5m)  
 Overall Length 15.500m  
 Overall Width 2.550m  
 Overall Body Height 3.581m  
 Min Body Ground Clearance 0.411m  
 Max Track Width 2.500m  
 Lock to lock time 6.00s  
 Kerb to Kerb Turning Radius 6.530m

	VEHICLE BODY SWEEP PATH (FORWARD GEAR)
	VEHICLE CHASSIS SWEEP PATH

P01	15.05.23	FIRST ISSUE	CB	SKT	SKT
REV	DATE	DESCRIPTION	BY	CHK	APP

REVISIONS

CLIENT

**MORECAMBE OFFSHORE WIND FARM LTD AND MORGAN OFFSHORE WINDFARM LTD**

**MORGAN AND MORECAMBE OFFSHORE WIND FARMS TRANSMISSION ASSETS**

TITLE

**ACCESS A1  
SWEPT PATH ANALYSIS**



DRAWN	CB	CHECKED	SKT	APPROVED	SKT
DATE	15.05.2023	SCALE AT A3	1:1000	AUTOCAD REF.	
DRAWING No.	PC1165-RHD-ZZ-XX-SW-TP-0066				REVISION
CLIENT DWG No.					P01



2.4m x 90m

R15.0m

7.5m

R11.0m



2.4m x 90m

- NOTES**
1. Do not scale from this drawing, all dimensions are in metres unless noted otherwise.
  2. This drawing has been based upon Ordnance Survey Maps and Royal HaskoningDHV can not guarantee the accuracy of data.
  3. X-distance - the set back from the nearest edge of the carriageway from which the access will be taken
  4. Y-Distance - the SSD measured along the nearest edge of the carriageway to its intersection with the centreline of the access.
  5. All vegetation to be cleared/trimmed within identified visibility envelope and thereafter maintained in accordance with Local Highway Authority maintenance practices.

**KEY**

- EXISTING ARRANGEMENT
- PROPOSED ACCESS BOUNDARY/ROAD MARKINGS
- MORGAN AND MORECAMBE ORDER LIMITS
- VISIBILITY SPLAY FOR ASSUMED JUNCTION LOCATION
- FULL DEPTH CARRIAGEWAY CONSTRUCTION WITH BOUND SURFACE

REV	DATE	DESCRIPTION	BY	CHK	APP
P01	21.05.24	FIRST ISSUE	CB	SKT	SKT

REVISIONS

CLIENT

MORECAMBE OFFSHORE WIND FARM LTD AND MORGAN OFFSHORE WINDFARM LTD

PROJECT  
MORGAN AND MORECAMBE OFFSHORE WIND FARMS TRANSMISSION ASSETS

TITLE  
ACCESS A2  
GENERAL ARRANGEMENT



DRAWN	CHECKED	APPROVED
CB	SKT	SKT

DATE	SCALE	AUTOCAD REF.	REVISION
21.05.24	AT A3 1:500		

DRAWING No.	CLIENT DWG No.
PC1165-RHD-ZZ-XX-SW-TP-0149	P01



**NOTES**  
 1. Do not scale from this drawing, all dimensions are in metres unless noted otherwise.  
 2. This drawing has been based upon Ordnance Survey Maps and Royal HaskoningDHV can not guarantee the accuracy of data.

**KEY**

- EXISTING ARRANGEMENT
- PROPOSED ACCESS BOUNDARY/ROAD MARKINGS
- MORGAN AND MORECAMBE ORDER LIMITS

**VEHICLE TRACKING**

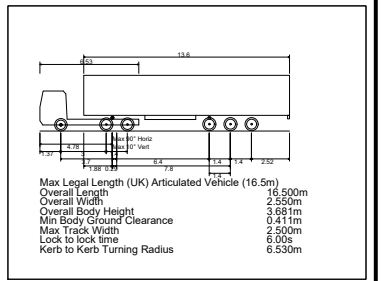

▨ VEHICLE BODY SWEPT PATH (FORWARD GEAR)  
 — VEHICLE CHASSIS SWEPT PATH

REV	DATE	DESCRIPTION	BY	CHK	APP
P01	21.05.24	FIRST ISSUE	CB	SKT	SKT

**REVISIONS**

CLIENT

**MORECAMBE OFFSHORE WIND FARM LTD AND MORGAN OFFSHORE WINDFARM LTD**

**MORGAN AND MORECAMBE OFFSHORE WIND FARMS TRANSMISSION ASSETS**

**ACCESS A2 SWEPT PATH ANALYSIS**



DRAWN	CHECKED	APPROVED
CB	SKT	SKT
DATE	SCALE AT A3	AUTOCAD REF.
21.05.24	1:500	
DRAWING No.	PC1165-RHD-ZZ-XX-SW-TP-0150	REVISION
CLIENT DWG No.		P01

ARTICULATED HGV INGRESS

ARTICULATED HGV EGRESS

DRAWING No.  
PC1165-RHD-ZZ-XX-SW-TP-0001

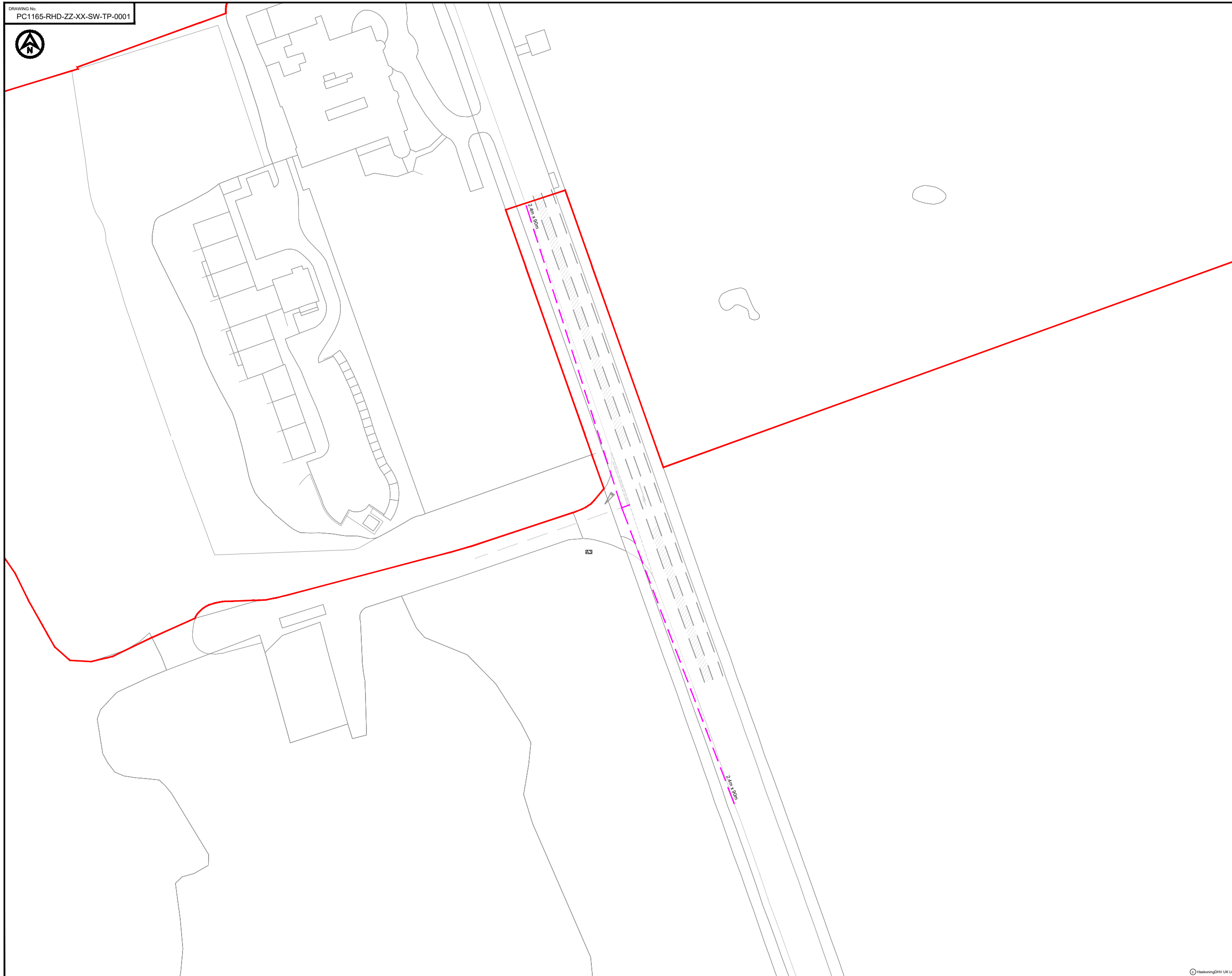

- NOTES**
1. Do not scale from this drawing, all dimensions are in metres unless noted otherwise.
  2. This drawing has been based upon Ordnance Survey Maps and Royal HaskoningDHV can not guarantee the accuracy of data. Carriageway lines are estimated from aerial mapping due to recent highway scheme not being recorded on OS mapping.
  3. X-distance - the set back from the nearest edge of the carriageway from which the access will be taken.
  4. Y-Distance - the SSD measured along the nearest edge of the carriageway to its intersection with the centreline of the access.
  5. All vegetation to be cleared/trimmed within identified visibility envelope and thereafter maintained in accordance with Local Highway Authority maintenance practices.

**KEY**

	EXISTING ARRANGEMENT
	VISIBILITY SPLAY FOR ASSUMED JUNCTION LOCATION
	MORGAN AND MORECAMBE ORDER LIMITS

REV	DATE	DESCRIPTION	BY	CHK	APP
P02	15.05.23	UPDATED IN LINE WITH COMMENTS	CB	SKT	SKT
P01	05.05.23	FIRST ISSUE	CB	SKT	SKT

REVISIONS

CLIENT

**MORECAMBE OFFSHORE WIND FARM LTD AND MORGAN OFFSHORE WINDFARM LTD**

**PROJECT**  
MORGAN AND MORECAMBE OFFSHORE WIND FARMS TRANSMISSION ASSETS

**TITLE**  
ACCESS A3  
GENERAL ARRANGEMENT



DRAWN	CB	CHECKED	SKT	APPROVED	SKT
DATE	05.05.23	SCALE AT A3	1:750	AUTOCAD REF.	
DRAWING No.	PC1165-RHD-ZZ-XX-SW-TP-0001				REVISION
CLIENT DWG No.					P02

DRAWING No.  
PC1165-RHD-ZZ-XX-SW-TP-0050



**NOTES**  
 1. Do not scale from this drawing, all dimensions are in metres unless noted otherwise.  
 2. This drawing has been based upon Ordnance Survey Maps and Royal HaskoningDHV can not guarantee the accuracy of data.

**KEY**

	EXISTING ARRANGEMENT
	MORGAN AND MORECAMBE ORDER LIMITS

**VEHICLE TRACKING**

Max Legal Length (UK) Articulated Vehicle (16.5m)  
 Overall Length 16.500m  
 Overall Width 2.550m  
 Overall Body Height 3.681m  
 Min Body Ground Clearance 0.411m  
 Max Track Width 2.500m  
 Lock to lock time 6.90s  
 Kerb to Kerb Turning Radius 6.530m

VEHICLE BODY SWEEP PATH (FORWARD GEAR)  
 VEHICLE CHASSIS SWEEP PATH

REV	DATE	DESCRIPTION	BY	CHK	APP
P02	15.05.23	UPDATED IN LINE WITH COMMENTS	CB	SKT	SKT
P01	05.05.23	FIRST ISSUE	CB	SKT	SKT

REVISIONS

CLIENT

**MORECAMBE OFFSHORE WIND FARM LTD AND MORGAN OFFSHORE WINDFARM LTD**

PROJECT

**MORGAN AND MORECAMBE OFFSHORE WIND FARMS TRANSMISSION ASSETS**

TITLE

**ACCESS A3 SWEEP PATH ANALYSIS**



DRAWN	CB	CHECKED	SKT	APPROVED	SKT
DATE	05.05.2023	SCALE AT A3	1:500	AUTOCAD REF.	
DRAWING No.	PC1165-RHD-ZZ-XX-SW-TP-0050				REVISION
CLIENT DWG No.					P02

ARTICULATED HGV INGRESS

ARTICULATED HGV EGRESS

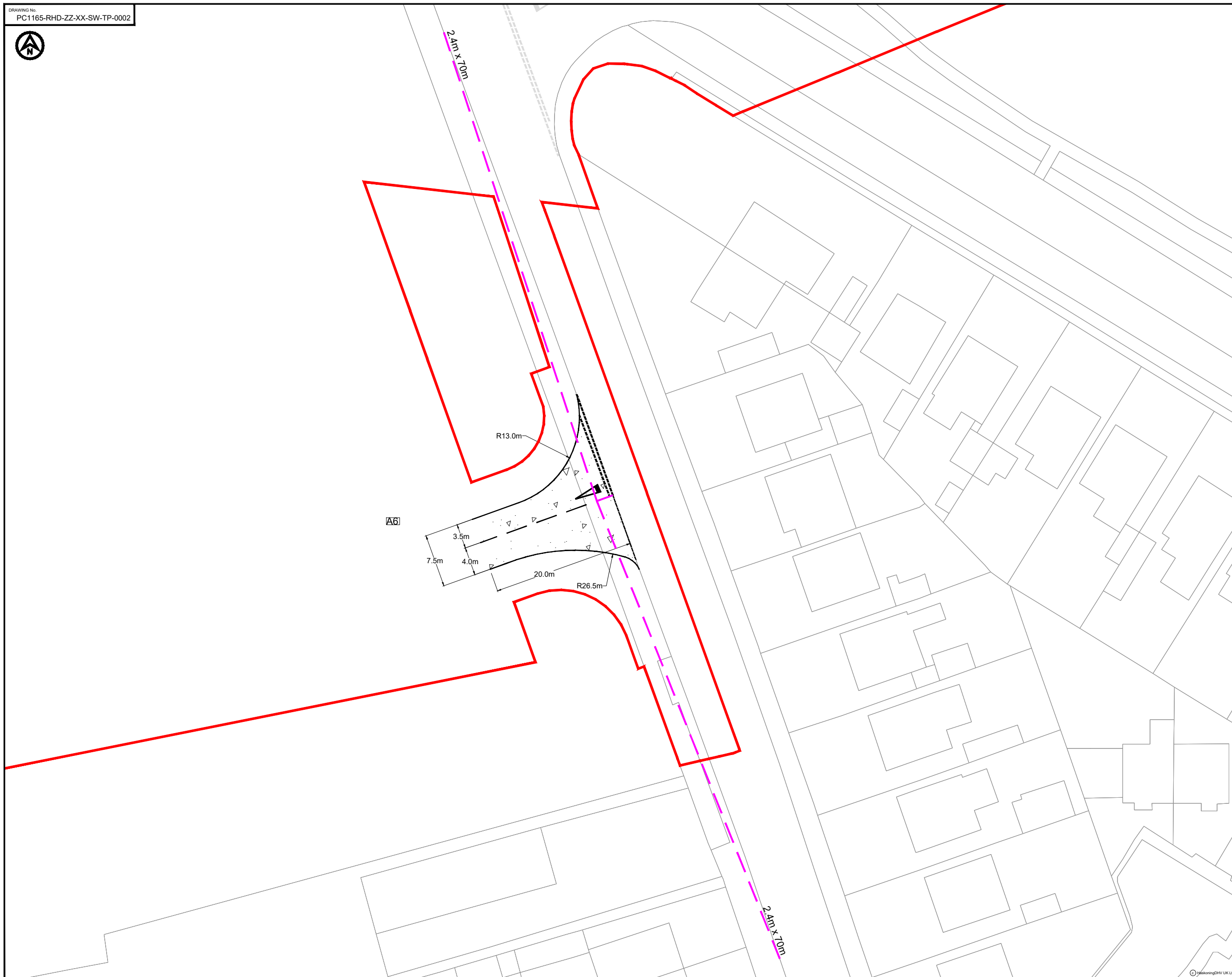

- NOTES**
1. Do not scale from this drawing, all dimensions are in metres unless noted otherwise.
  2. This drawing has been based upon Ordnance Survey Maps and Royal HaskoningDHV can not guarantee the accuracy of data.
  3. X-distance - the set back from the nearest edge of the carriageway from which the access will be taken
  4. Y-Distance - the SSD measured along the nearest edge of the carriageway to its intersection with the centreline of the access.
  5. All vegetation to be cleared/trimmed within identified visibility envelope and thereafter maintained in accordance with Local Highway Authority maintenance practices.

**KEY**

- EXISTING ARRANGEMENT
- PROPOSED ACCESS BOUNDARY/ROAD MARKINGS
- MORGAN AND MORECAMBE ORDER LIMITS
- - - VISIBILITY SPLAY FOR ASSUMED JUNCTION LOCATION
- FULL DEPTH CARRIAGEWAY CONSTRUCTION WITH BOUND SURFACE

REV	DATE	DESCRIPTION	BY	CHK	APP
P04	29.07.24	UPDATED ACCESS BELLMOUTH	AA	SKT	SKT
P03	25.07.24	UPDATED SHARED WORK AREA	AA	SKT	SKT
P02	15.05.23	UPDATED IN LINE WITH COMMENTS	CB	SKT	SKT
P01	05.05.23	FIRST ISSUE	CB	SKT	SKT

REVISIONS

CLIENT

**MORECAMBE OFFSHORE WIND FARM LTD AND MORGAN OFFSHORE WINDFARM LTD**

PROJECT

**MORGAN AND MORECAMBE OFFSHORE WIND FARMS TRANSMISSION ASSETS**

TITLE

**ACCESS A6  
GENERAL ARRANGEMENT**



DRAWN	CHECKED	APPROVED
CB	SKT	SKT
DATE	SCALE AT A3	AUTOCAD REF.
05.05.23	1:500	
DRAWING No.	PC1165-RHD-ZZ-XX-SW-TP-0002	REVISION
CLIENT DWG No.		P04

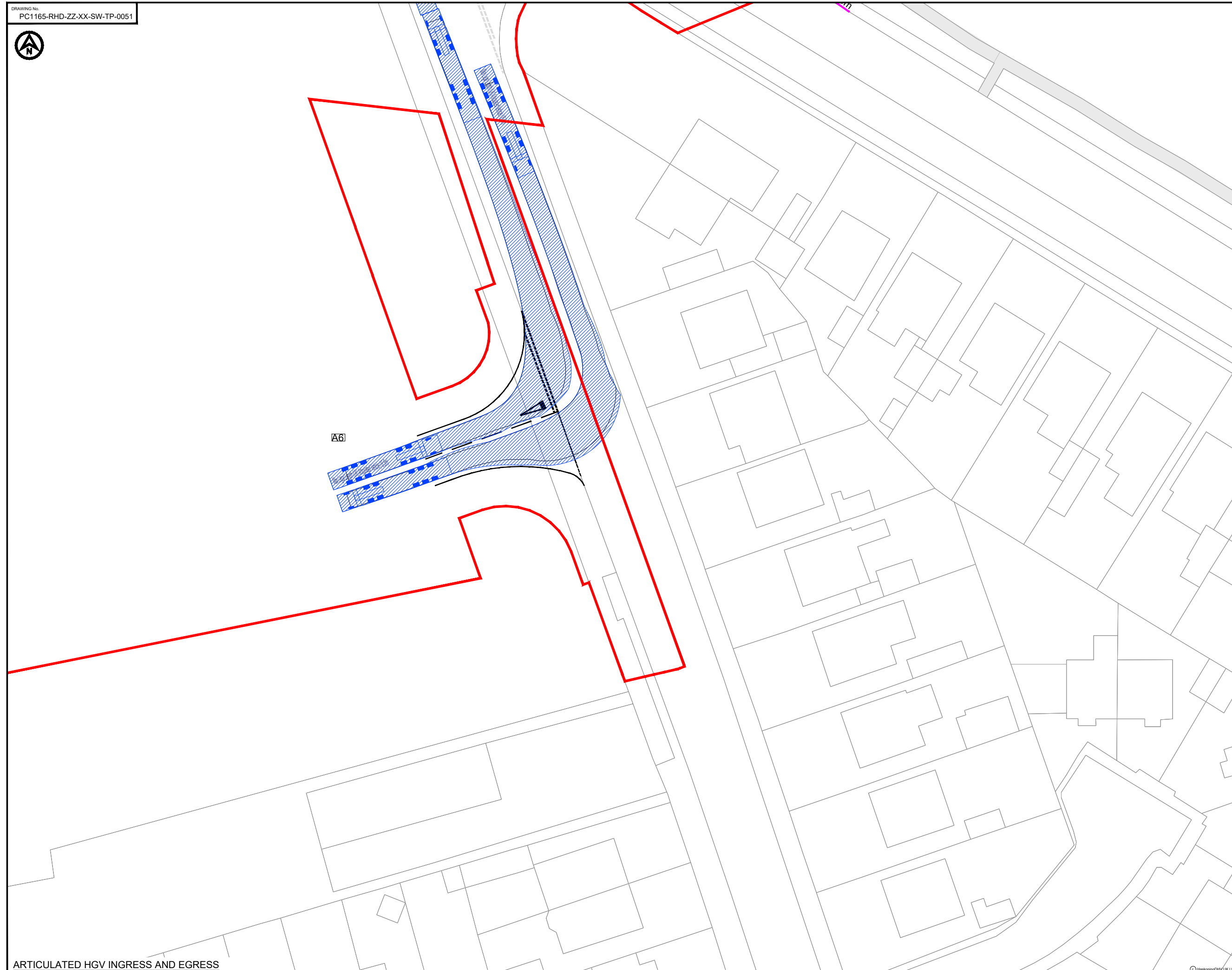

**NOTES**  
 1. Do not scale from this drawing, all dimensions are in metres unless noted otherwise.  
 2. This drawing has been based upon Ordnance Survey Maps and Royal HaskoningDHV can not guarantee the accuracy of data.

**KEY**

- EXISTING ARRANGEMENT
- PROPOSED ACCESS BOUNDARY/ROAD MARKINGS
- MORGAN AND MORECAMBE ORDER LIMITS

**VEHICLE TRACKING**

Max Legal Length (UK) Articulated Vehicle (16.5m)  
 Overall Length 16.500m  
 Overall Width 2.550m  
 Overall Body Height 3.881m  
 Min Body Ground Clearance 0.411m  
 Max Track Width 2.500m  
 Lock to lock time 6.00s  
 Kerb to Kerb Turning Radius 6.530m

▨ VEHICLE BODY SWEEP PATH (FORWARD GEAR)  
 — VEHICLE CHASSIS SWEEP PATH

REV	DATE	DESCRIPTION	BY	CHK	APP
P01	05.05.23	FIRST ISSUE	CB	SKT	SKT

REVISIONS

CLIENT

**MORECAMBE OFFSHORE WIND FARM LTD AND MORGAN OFFSHORE WINDFARM LTD**

PROJECT

**MORGAN AND MORECAMBE OFFSHORE WIND FARMS TRANSMISSION ASSETS**

TITLE

**ACCESS A6 SWEEP PATH ANALYSIS**



DRAWN	CB	CHECKED	SKT	APPROVED	SKT
DATE	05.05.2023	SCALE AT A3	1:500	AUTOCAD REF.	
DRAWING No.	PC1165-RHD-ZZ-XX-SW-TP-0051				REVISION
CLIENT DWG No.					P01





- NOTES**
1. Do not scale from this drawing, all dimensions are in metres unless noted otherwise.
  2. This drawing has been based upon Ordnance Survey Maps and Royal HaskoningDHV can not guarantee the accuracy of data.
  3. X-distance - the set back from the nearest edge of the carriageway from which the access will be taken
  4. Y-Distance - the SSD measured along the nearest edge of the carriageway to its intersection with the centreline of the access.
  5. All vegetation to be cleared/trimmed within identified visibility envelope and thereafter maintained in accordance with Local Highway Authority maintenance practices.

**KEY**

- EXISTING ARRANGEMENT
- PROPOSED ACCESS BOUNDARY/ROAD MARKINGS
- MORGAN AND MORECAMBE ORDER LIMITS
- - - VISIBILITY SPLAY FOR ASSUMED JUNCTION LOCATION
- PROPOSED NEW SHARED USE FACILITY TO TIE INTO EXISTING NETWORK
- PROPOSED NEW UNCONTROLLED TACTILE CROSS OVER
- FULL DEPTH CARRIAGEWAY CONSTRUCTION WITH BOUND SURFACE

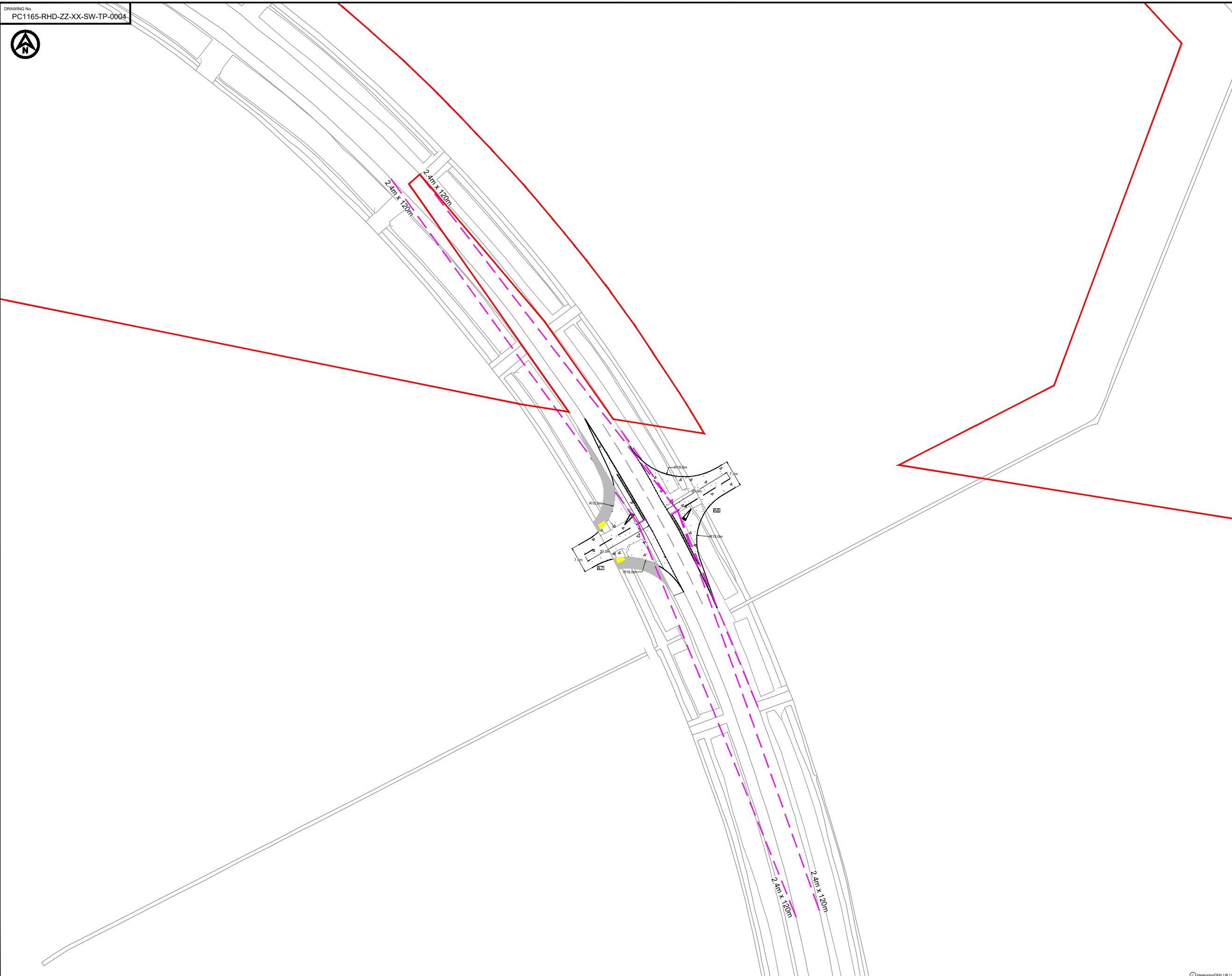

REV	DATE	DESCRIPTION	BY	CHK	APP
P02	15.05.23	UPDATED WORK AREA AND ORDER LIMITS	AA	SKT	SKT
P01	05.05.23	FIRST ISSUE	CB	SKT	SKT

REVISIONS

CLIENT

**MORECAMBE OFFSHORE WIND FARM LTD AND MORGAN OFFSHORE WINDFARM LTD**

PROJECT

**MORGAN AND MORECAMBE OFFSHORE WIND FARMS TRANSMISSION ASSETS**

TITLE

**ACCESS A7 AND A8 GENERAL ARRANGEMENT**



DRAWN	CHECKED	APPROVED
CB	SKT	SKT
DATE	SCALE AT A3	AUTOCAD REF.
05.05.23	1:750	
DRAWING No.	PC1165-RHD-ZZ-XX-SW-TP-0004	REVISION
CLIENT DWG No.		P02

DRAWING No.  
PC1165-RHD-ZZ-XX-SW-TP-0052

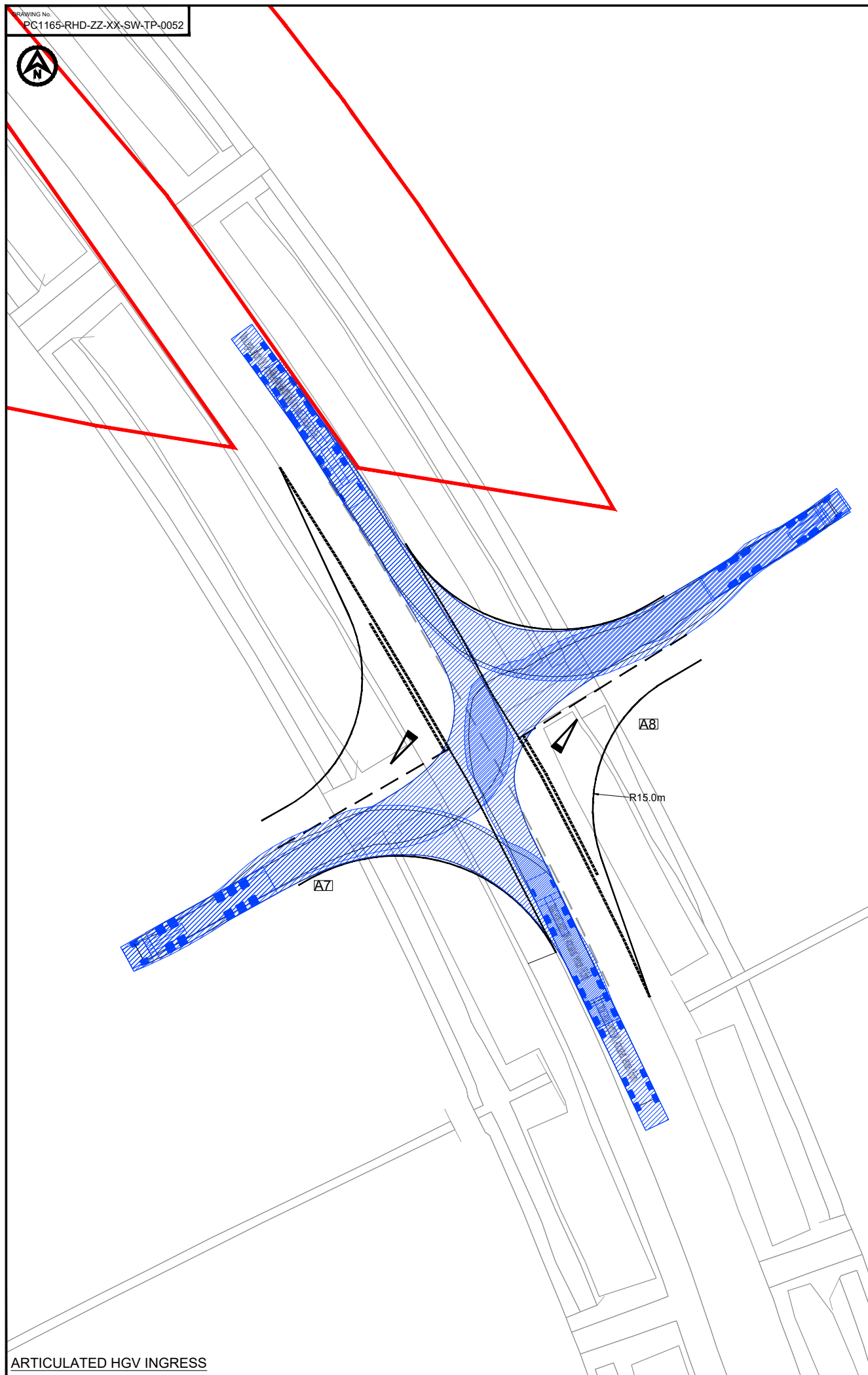

ARTICULATED HGV INGRESS

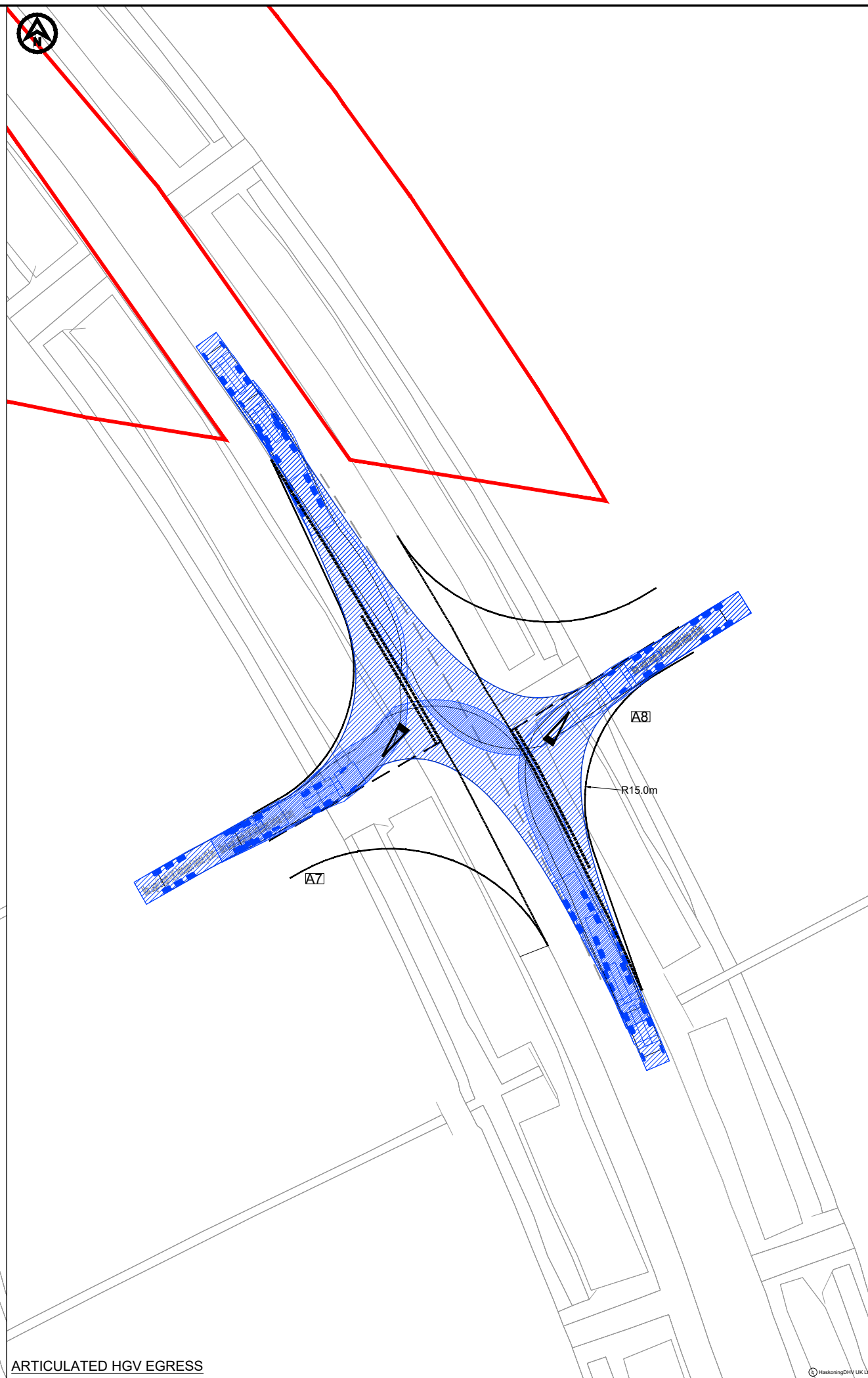

ARTICULATED HGV EGRESS

- NOTES**
1. Do not scale from this drawing, all dimensions are in metres unless noted otherwise.
  2. This drawing has been based upon Ordnance Survey Maps and Royal HaskoningDHV can not guarantee the accuracy of data.

**KEY**

	EXISTING ARRANGEMENT
	PROPOSED ACCESS BOUNDARY/ROAD MARKINGS
	MORGAN AND MORECAMBE ORDER LIMITS

**VEHICLE TRACKING**

Max Legal Length (UK) Articulated Vehicle (16.5m)  
 Overall Length 16.50m  
 Overall Width 2.550m  
 Overall Body Height 3.681m  
 Min Body Ground Clearance 0.411m  
 Max Track Width 2.500m  
 Lock to lock time 6.00s  
 Kerb to Kerb Turning Radius 6.535m

	VEHICLE BODY SWEEP PATH (FORWARD GEAR)
	VEHICLE CHASSIS SWEEP PATH

P01	05.05.23	FIRST ISSUE	CB	SKT	SKT
REV	DATE	DESCRIPTION	BY	CHK	APP

REVISIONS

CLIENT

**MORECAMBE OFFSHORE WIND FARM LTD AND MORGAN OFFSHORE WINDFARM LTD**

PROJECT

**MORGAN AND MORECAMBE OFFSHORE WIND FARMS TRANSMISSION ASSETS**

TITLE

**ACCESS A7 AND A8 SWEEP PATH ANALYSIS**



DRAWN	CB	CHECKED	SKT	APPROVED	SKT
DATE	05.05.2023	SCALE AT A3	1:500	AUTOCAD REF.	
DRAWING No.	PC1165-RHD-ZZ-XX-SW-TP-0052				REVISION
CLIENT DWG No.					P01



- NOTES**
1. Do not scale from this drawing, all dimensions are in metres unless noted otherwise.
  2. This drawing has been based upon Ordnance Survey Maps and Royal HaskoningDHV can not guarantee the accuracy of data.
  3. X-Distance - the set back from the nearest edge of the carriageway from which the access will be taken
  4. Y-Distance - the SSD measured along the nearest edge of the carriageway to its intersection with the centreline of the access.
  5. All vegetation to be cleared/trimmed within identified visibility envelope and thereafter maintained in accordance with Local Highway Authority maintenance practices.

- KEY**
- EXISTING ARRANGEMENT
  - PROPOSED ACCESS BOUNDARY/ROAD MARKINGS
  - MORGAN AND MORECAMBE ORDER LIMITS
  - - - VISIBILITY SPLAY FOR ASSUMED JUNCTION LOCATION
  - FULL DEPTH CARRIAGEWAY CONSTRUCTION WITH BOUND SURFACE

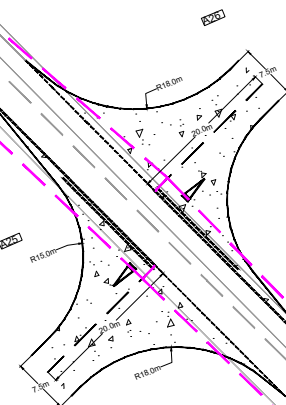
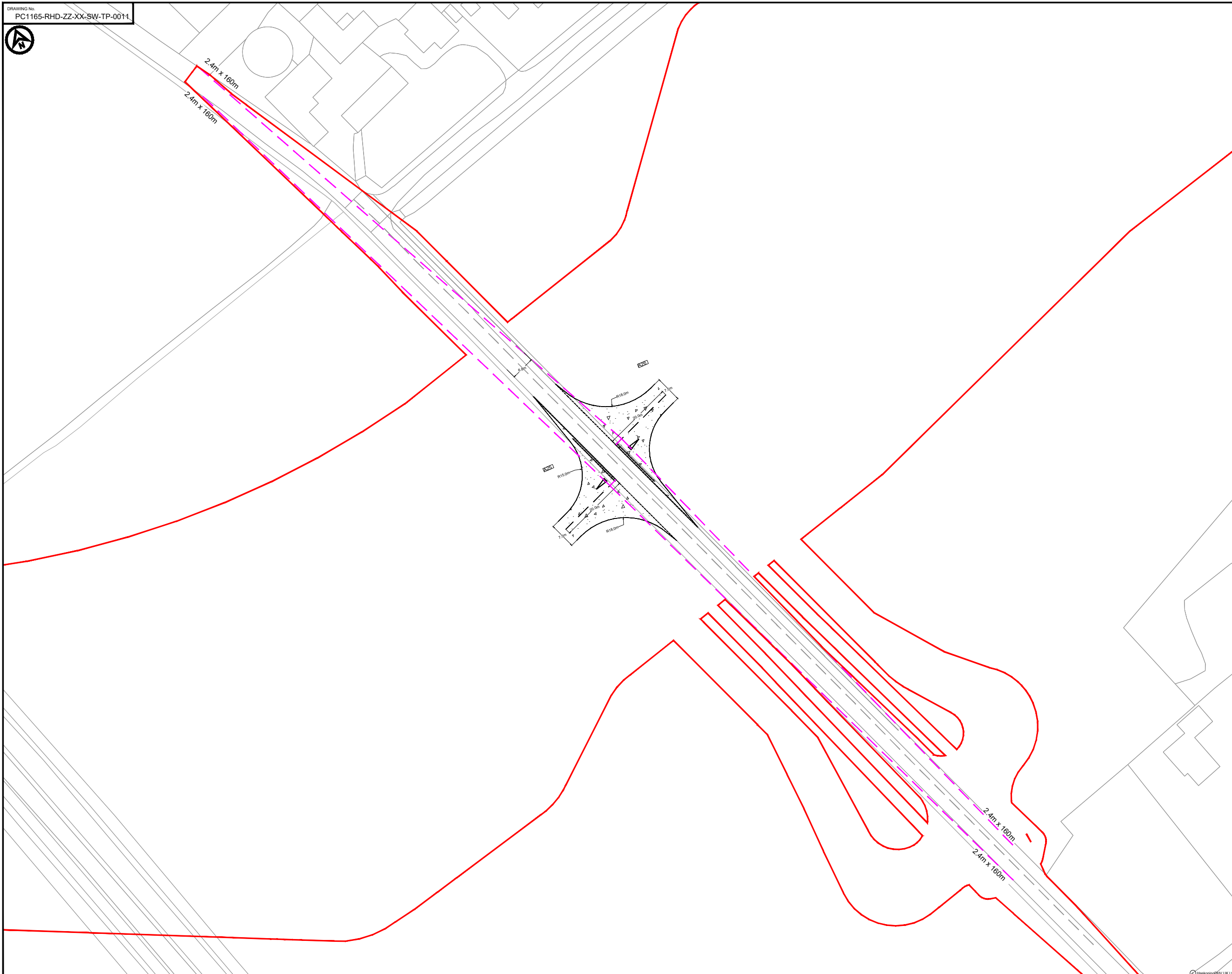

REV	DATE	DESCRIPTION	BY	CHK	APP
P02	01.05.24	UPDATED WORK AREA AND ORDER LIMITS	AA	SKT	SKT
P01	05.05.23	FIRST ISSUE	CB	SKT	SKT

REVISIONS

CLIENT

**MORECAMBE OFFSHORE WIND FARM LTD AND MORGAN OFFSHORE WINDFARM LTD**

**PROJECT**  
MORGAN AND MORECAMBE OFFSHORE WIND FARMS TRANSMISSION ASSETS

**TITLE**  
ACCESS A25 AND A26 GENERAL ARRANGEMENT



DRAWN	CHECKED	APPROVED
CB	SKT	SKT

DATE: 05.05.23 SCALE AT A3: 1:1000 AUTOCAD REF:

DRAWING No.	REVISION
PC1165-RHD-ZZ-XX-SW-TP-0011	P02

CLIENT DWG No.



**NOTES**  
 1. Do not scale from this drawing, all dimensions are in metres unless noted otherwise.  
 2. This drawing has been based upon Ordnance Survey Maps and Royal HaskoningDHV can not guarantee the accuracy of data.

**KEY**  
 — EXISTING ARRANGEMENT  
 — PROPOSED ACCESS BOUNDARY/ROAD MARKINGS  
 — MORGAN AND MORECAMBE ORDER LIMITS

**VEHICLE TRACKING**

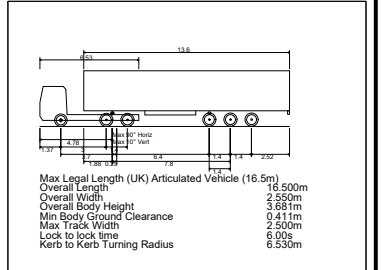

▨ VEHICLE BODY SWEEP PATH (FORWARD GEAR)  
 — VEHICLE CHASSIS SWEEP PATH

REV	DATE	DESCRIPTION	BY	CHK	APP
P01	05.05.23	FIRST ISSUE	CB	SKT	SKT

**REVISIONS**

**CLIENT**

MORECAMBE OFFSHORE WIND FARM LTD AND MORGAN OFFSHORE WINDFARM LTD

**PROJECT**

MORGAN AND MORECAMBE OFFSHORE WIND FARMS TRANSMISSION ASSETS

**TITLE**

ACCESS A25 AND A26 SWEEP PATH ANALYSIS



DRAWN	CB	CHECKED	SKT	APPROVED	SKT
DATE	05.05.2023	SCALE AT A3	1:500	AUTOCAD REF.	
DRAWING No.	PC1165-RHD-ZZ-XX-SW-TP-0056				REVISION
CLIENT DWG No.					P01

ARTICULATED HGV INGRESS

ARTICULATED HGV EGRESS

DRAWING No.  
PC1165-RHD-ZZ-XX-SW-TP-0013



- NOTES**
1. Do not scale from this drawing, all dimensions are in metres unless noted otherwise.
  2. This drawing has been based upon Ordnance Survey Maps and Royal HaskoningDHV can not guarantee the accuracy of data. OS mapping to east and south is currently missing.
  3. X-distance - the set back from the nearest edge of the carriageway from which the access will be taken.
  4. Y-distance - the SSD measured along the nearest edge of the carriageway to its intersection with the centreline of the access.
  5. All vegetation to be cleared/trimmed within identified visibility envelope and thereafter maintained in accordance with Local Highway Authority maintenance practices.

- KEY**
- EXISTING ARRANGEMENT
  - PROPOSED ACCESS BOUNDARY/ROAD MARKINGS
  - VISIBILITY SPLAY FOR ASSUMED JUNCTION LOCATION
  - MORGAN AND MORECAMBE ORDER LIMITS
  - FULL DEPTH CARRIAGEWAY CONSTRUCTION WITH BOUND SURFACE

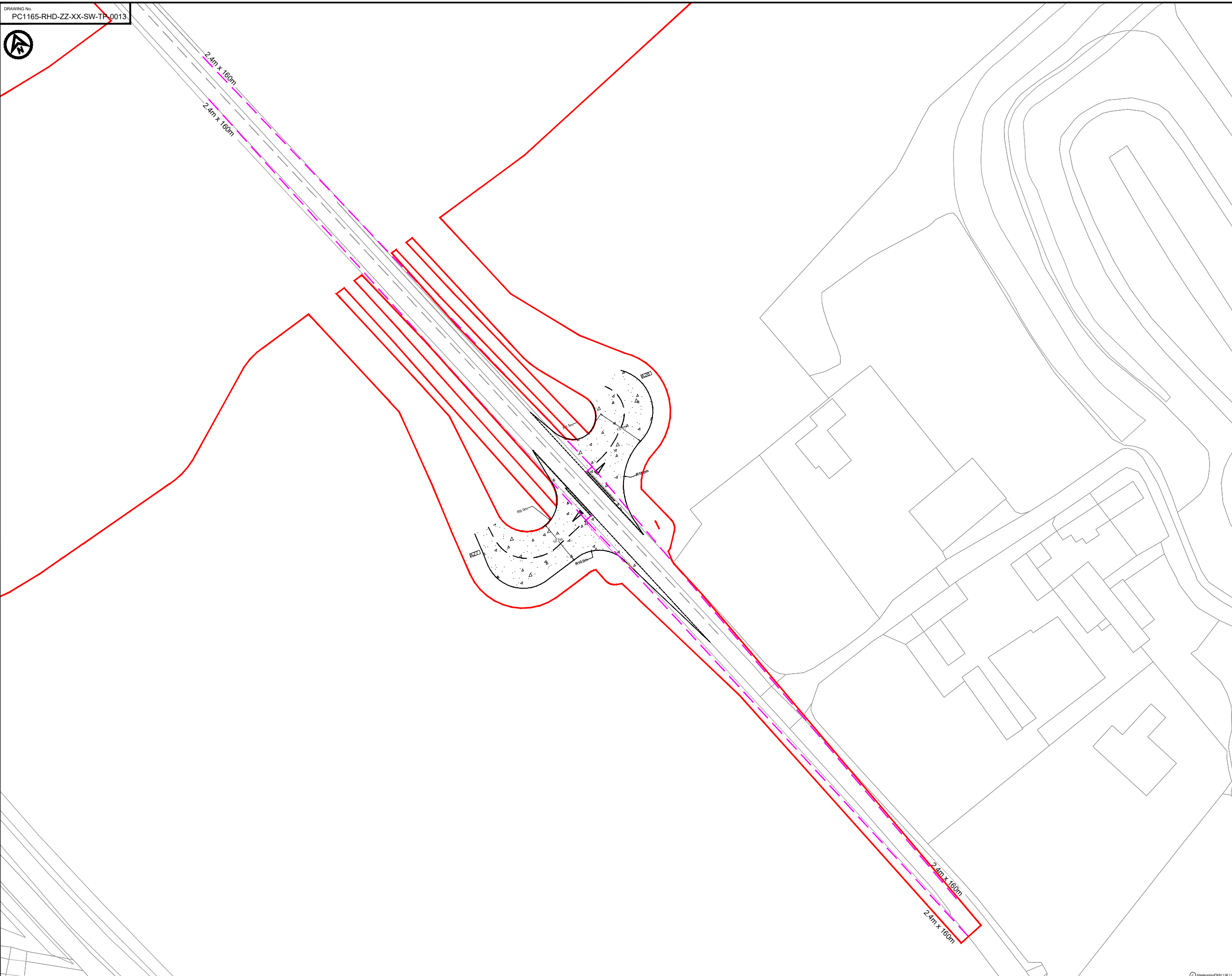

REV	DATE	DESCRIPTION	BY	CHK	APP
P03	01.05.24	UPDATED WORK AREA AND ORDER LIMITS	AA	SKT	SKT
P02	05.01.24	UPDATED THE LOCATION OF A37	AA	RNE	RNE
P01	05.05.23	FIRST ISSUE	CB	SKT	SKT

REVISIONS

CLIENT

**MORECAMBE OFFSHORE WIND FARM LTD AND MORGAN OFFSHORE WINDFARM LTD**

**PROJECT**  
MORGAN AND MORECAMBE OFFSHORE WIND FARMS TRANSMISSION ASSETS

**TITLE**  
ACCESS A27 AND A28 GENERAL ARRANGEMENT



DRAWN	CHECKED	APPROVED
CB	SKT	SKT
DATE	SCALE AT A3	AUTOCAD REF.
05.05.23	1:1000	
DRAWING No. PC1165-RHD-ZZ-XX-SW-TP-0013	REVISION	
CLIENT DWG No.		P03

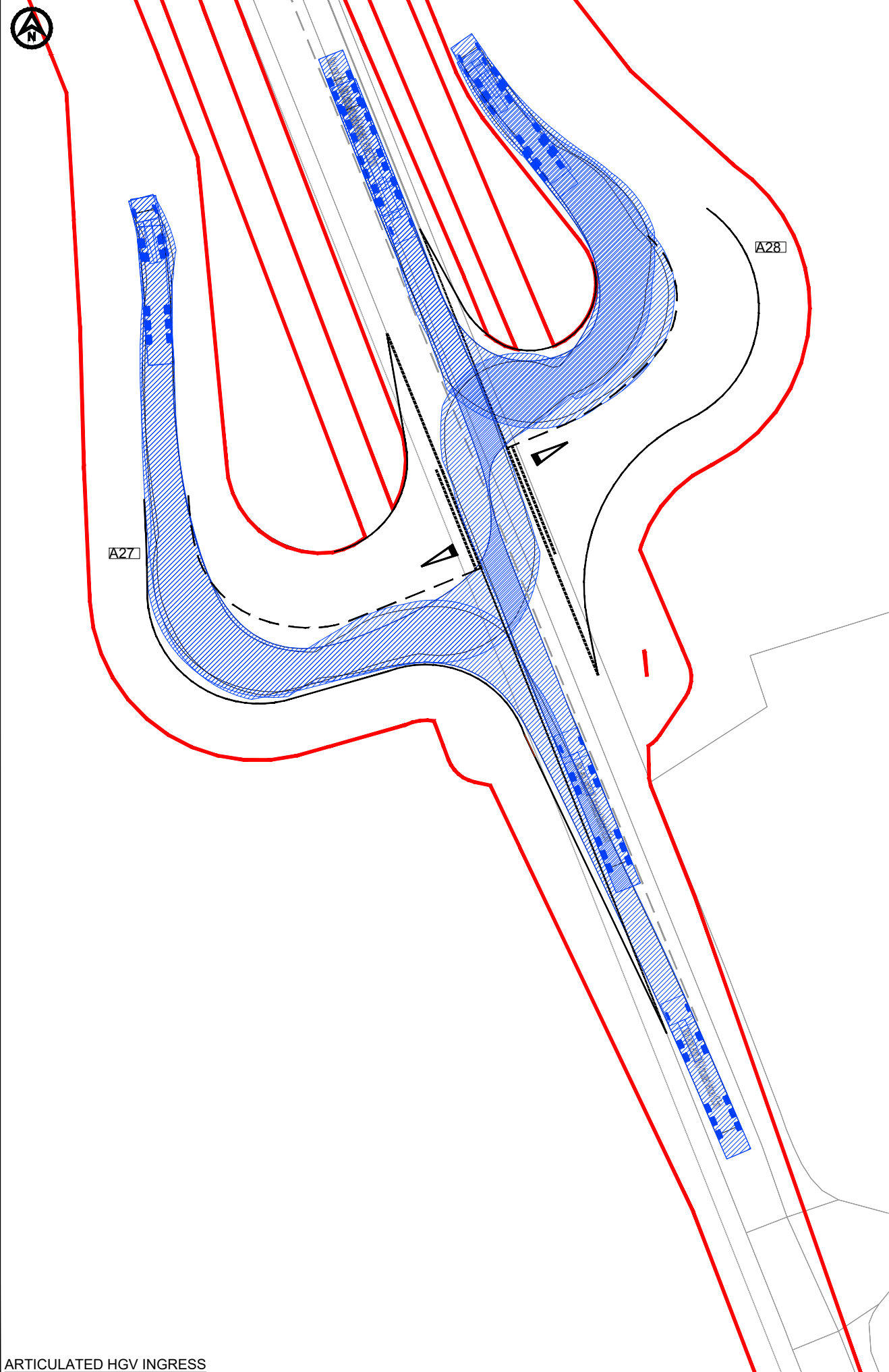

ARTICULATED HGV INGRESS

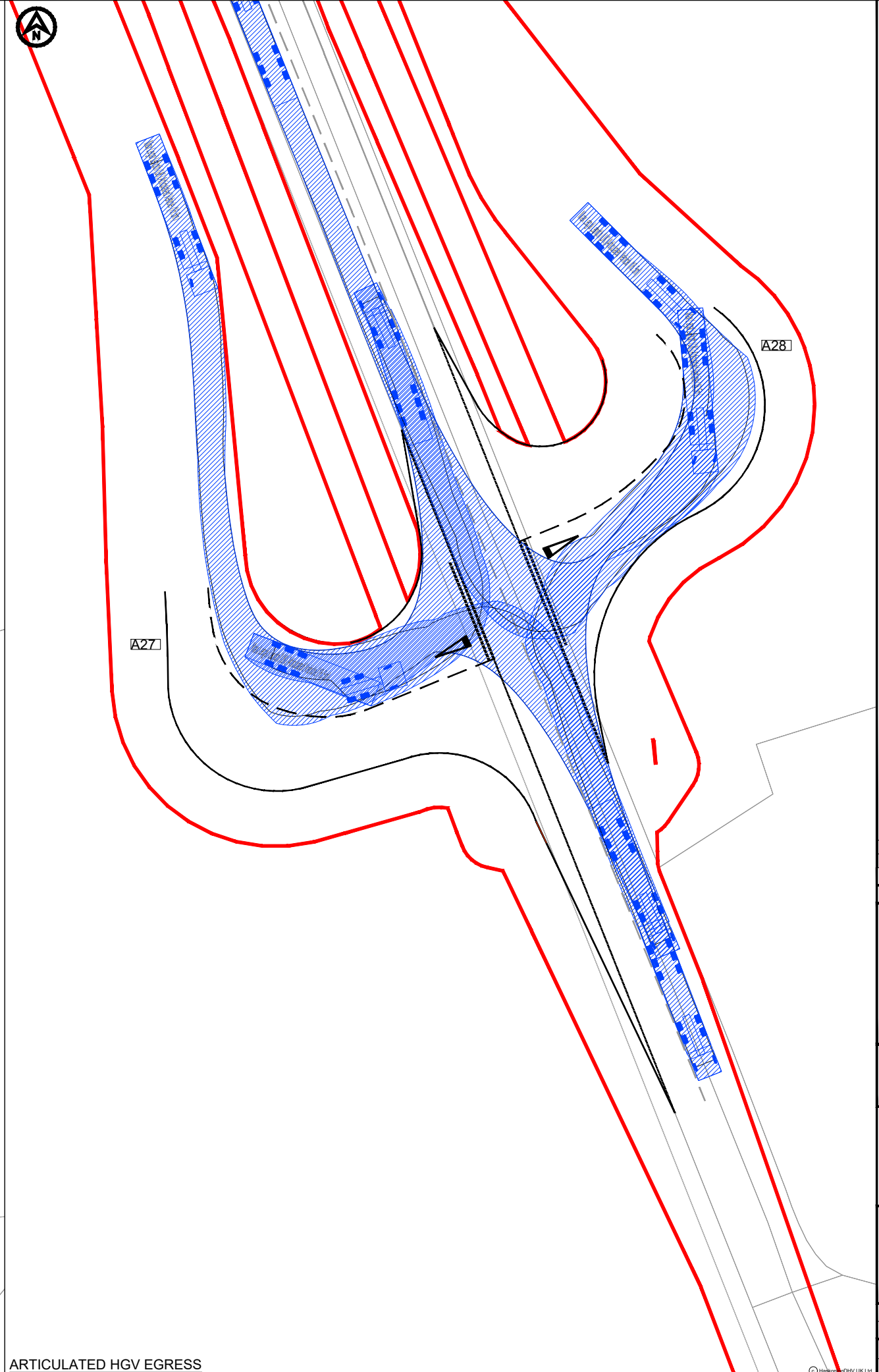

ARTICULATED HGV EGRESS

**NOTES**  
 1. Do not scale from this drawing, all dimensions are in metres unless noted otherwise.  
 2. This drawing has been based upon Ordnance Survey Maps and Royal HaskoningDHV can not guarantee the accuracy of data. OS mapping to east and south is currently missing.

**KEY**

- EXISTING ARRANGEMENT
- - - PROPOSED ACCESS BOUNDARY/ROAD MARKINGS
- MORGAN AND MORECAMBE ORDER LIMITS

**VEHICLE TRACKING**

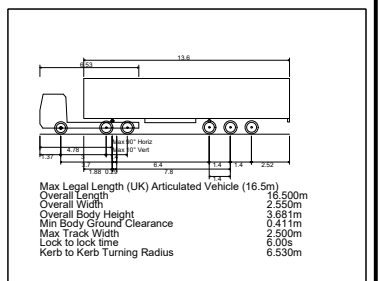

▨ VEHICLE BODY SWEEP PATH (FORWARD GEAR)  
 — VEHICLE CHASSIS SWEEP PATH

REV	DATE	DESCRIPTION	BY	CHK	APP
P02	05.01.24	UPDATED THE LOCATION OF A37	AA	RNE	RNE
P01	05.05.23	FIRST ISSUE	CB	SKT	SKT

**REVISIONS**

**CLIENT**

**MORECAMBE OFFSHORE WIND FARM LTD AND MORGAN OFFSHORE WINDFARM LTD**

**PROJECT**  
 MORGAN AND MORECAMBE OFFSHORE WIND FARMS TRANSMISSION ASSETS

**TITLE**  
 ACCESS A27 AND A28 SWEEP PATH ANALYSIS



DRAWN	CHECKED	APPROVED
CB	SKT	SKT
DATE	SCALE AT A3	AUTOCAD REF.
05.05.2023	1:500	
DRAWING No.	PC1165-RHD-ZZ-XX-SW-TP-0057	REVISION
CLIENT DWG No.		P02

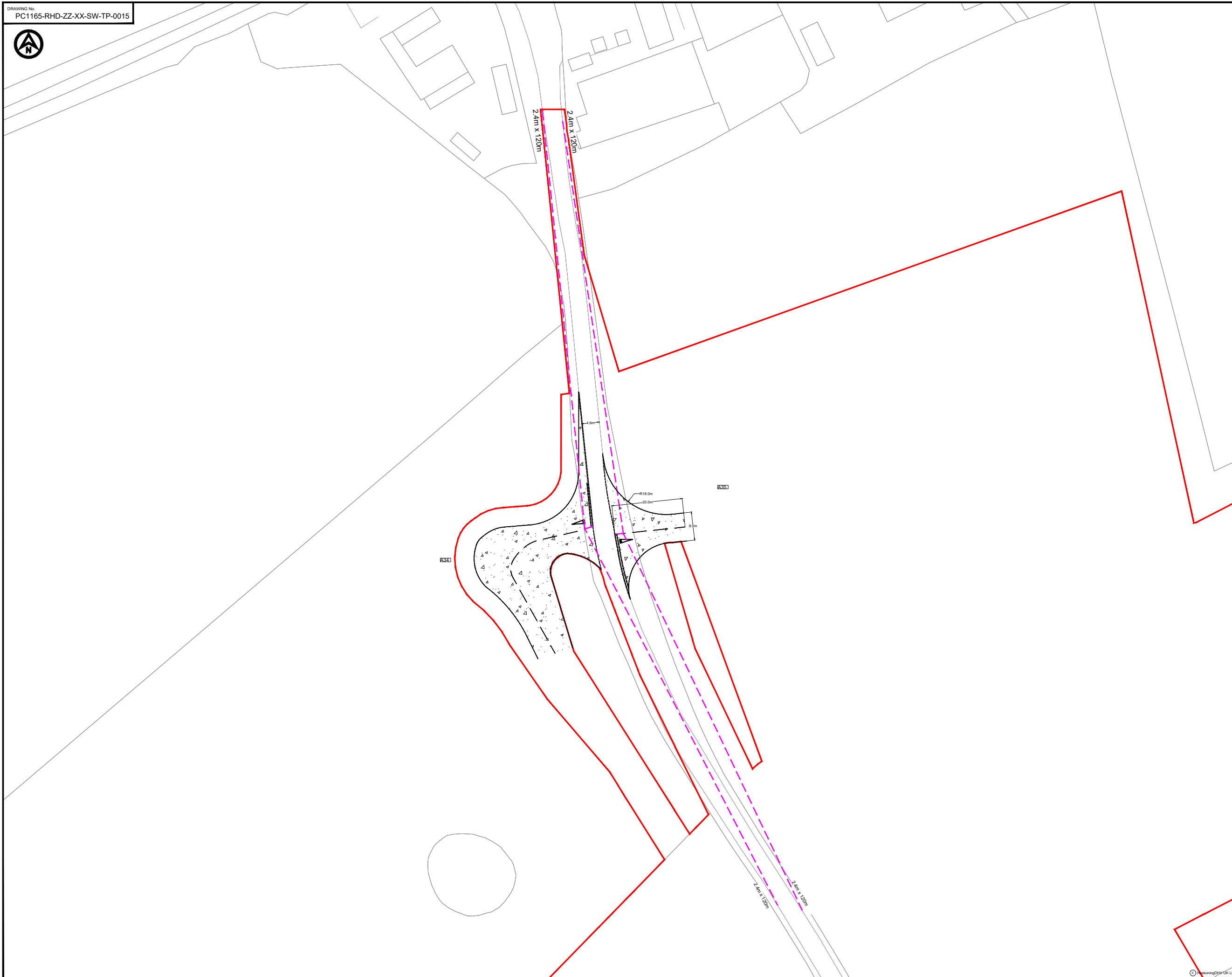

- NOTES**
1. Do not scale from this drawing, all dimensions are in metres unless noted otherwise.
  2. This drawing has been based upon Ordnance Survey Maps and Royal HaskoningDHV can not guarantee the accuracy of data.
  3. X-distance - the set back from the nearest edge of the carriageway from which the access will be taken
  4. Y-Distance - the SSD measured along the nearest edge of the carriageway to its intersection with the centreline of the access.
  5. All vegetation to be cleared/trimmed within identified visibility envelope and thereafter maintained in accordance with Local Highway Authority maintenance practices.

**KEY**

- EXISTING ARRANGEMENT
- PROPOSED ACCESS BOUNDARY/ROAD MARKINGS
- MORGAN AND MORECAMBE ORDER LIMITS
- - - VISIBILITY SPLAY FOR ASSUMED JUNCTION LOCATION
- [Pattern] FULL DEPTH CARRIAGEWAY CONSTRUCTION WITH BOUND SURFACE

P02	03.05.24	UPDATED WORK AREA AND ORDER LIMITS	AA	SKT	SKT
P01	05.05.23	FIRST ISSUE	CB	SKT	SKT
REV	DATE	DESCRIPTION	BY	CHK	APP

REVISIONS

CLIENT

**MORECAMBE OFFSHORE WIND FARM LTD AND MORGAN OFFSHORE WINDFARM LTD**

**PROJECT**  
MORGAN AND MORECAMBE OFFSHORE WIND FARMS TRANSMISSION ASSETS

**TITLE**  
ACCESS A34 AND A35 GENERAL ARRANGEMENT



DRAWN	CB	CHECKED	SKT	APPROVED	SKT
DATE	05.05.23	SCALE AT A3	1:1000	AUTOCAD REF.	
DRAWING No.	PC1165-RHD-ZZ-XX-SW-TP-0015				REVISION
CLIENT DWG No.					P02



**NOTES**  
 1. Do not scale from this drawing, all dimensions are in metres unless noted otherwise.  
 2. This drawing has been based upon Ordnance Survey Maps and Royal HaskoningDHV can not guarantee the accuracy of data.

**KEY**

- EXISTING ARRANGEMENT
- PROPOSED ACCESS BOUNDARY/ROAD MARKINGS
- MORGAN AND MORECAMBE ORDER LIMITS

**VEHICLE TRACKING**

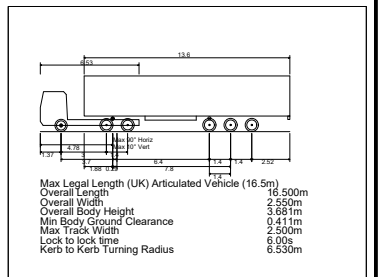

VEHICLE BODY SWEEP PATH (FORWARD GEAR)  
 VEHICLE CHASSIS SWEEP PATH

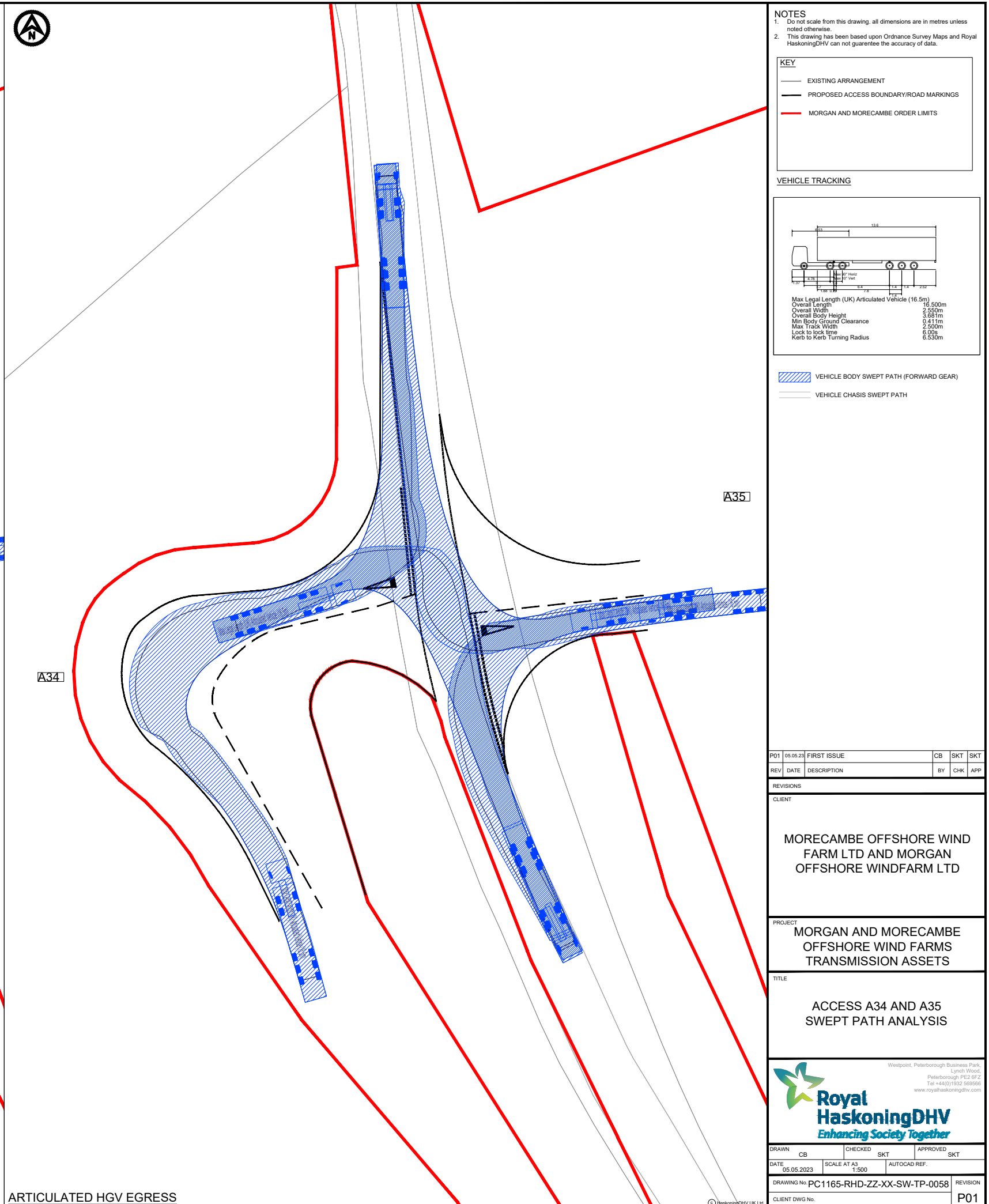
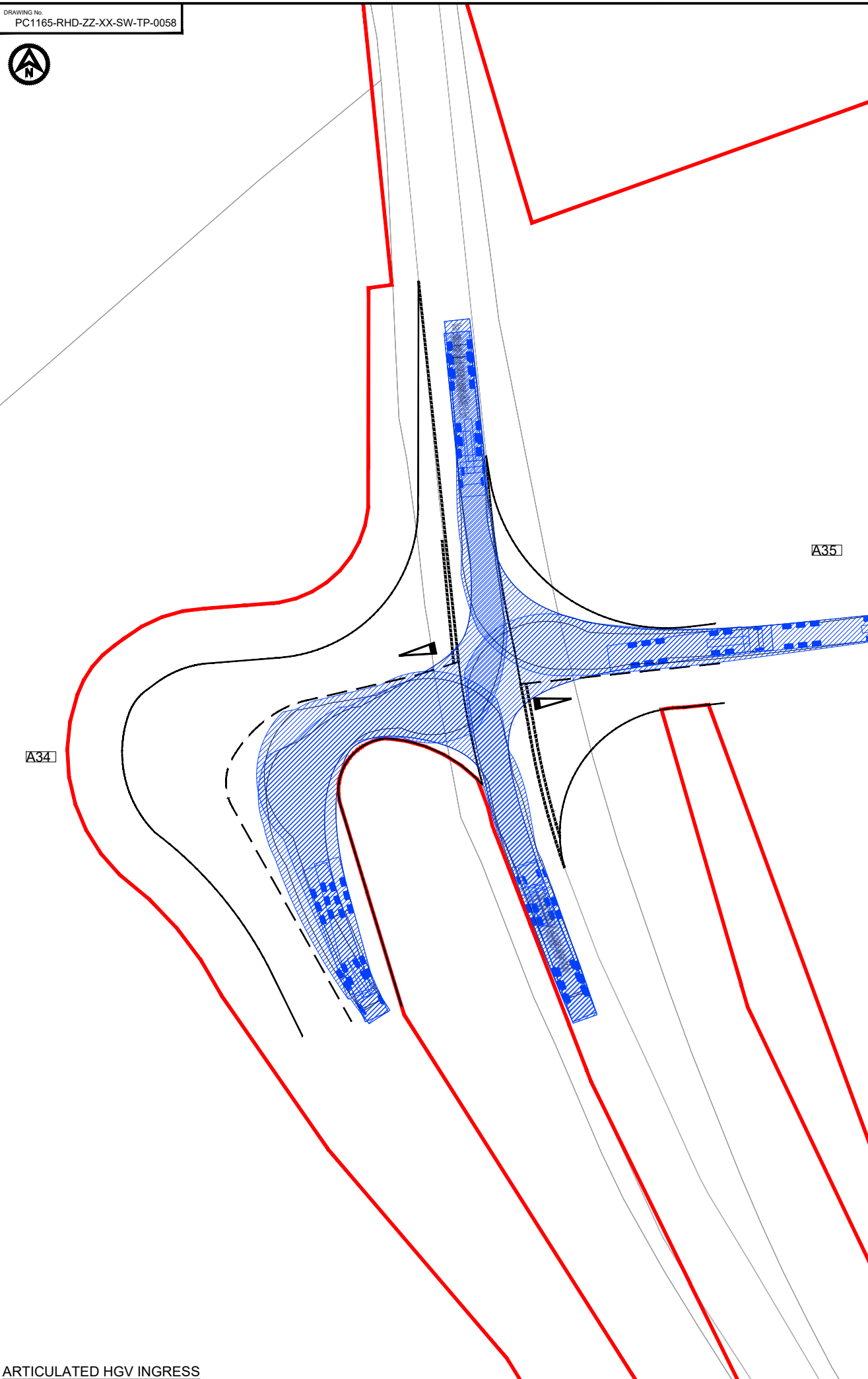

P01	05.05.23	FIRST ISSUE	CB	SKT	SKT
REV	DATE	DESCRIPTION	BY	CHK	APP

REVISIONS

CLIENT

MORECAMBE OFFSHORE WIND FARM LTD AND MORGAN OFFSHORE WINDFARM LTD

PROJECT  
MORGAN AND MORECAMBE OFFSHORE WIND FARMS TRANSMISSION ASSETS

TITLE  
ACCESS A34 AND A35 SWEEP PATH ANALYSIS



DRAWN	CHECKED	APPROVED
CB	SKT	SKT
DATE	SCALE AT A3	AUTOCAD REF.
05.05.2023	1:500	
DRAWING No.	PC1165-RHD-ZZ-XX-SW-TP-0058	REVISION
CLIENT DWG No.		P01

ARTICULATED HGV INGRESS

ARTICULATED HGV EGRESS



DRAWING No.  
PC1165-RHD-ZZ-XX-SW-TP-0017



- NOTES**
1. Do not scale from this drawing, all dimensions are in metres unless noted otherwise.
  2. This drawing has been based upon Ordnance Survey Maps and Royal HaskoningDHV can not guarantee the accuracy of data.
  3. X-Distance - the set back from the nearest edge of the carriageway from which the access will be taken
  4. Y-Distance - the SSD measured along the nearest edge of the carriageway to its intersection with the centreline of the access.
  5. All vegetation to be cleared/trimmed within identified visibility envelope and thereafter maintained in accordance with Local Highway Authority maintenance practices.

- KEY**
- EXISTING ARRANGEMENT
  - PROPOSED ACCESS BOUNDARY/ROAD MARKINGS
  - - - VISIBILITY SPLAY FOR ASSUMED JUNCTION LOCATION
  - MORGAN AND MORECAMBE ORDER LIMITS
  - FULL DEPTH CARRIAGEWAY CONSTRUCTION WITH BOUND SURFACE

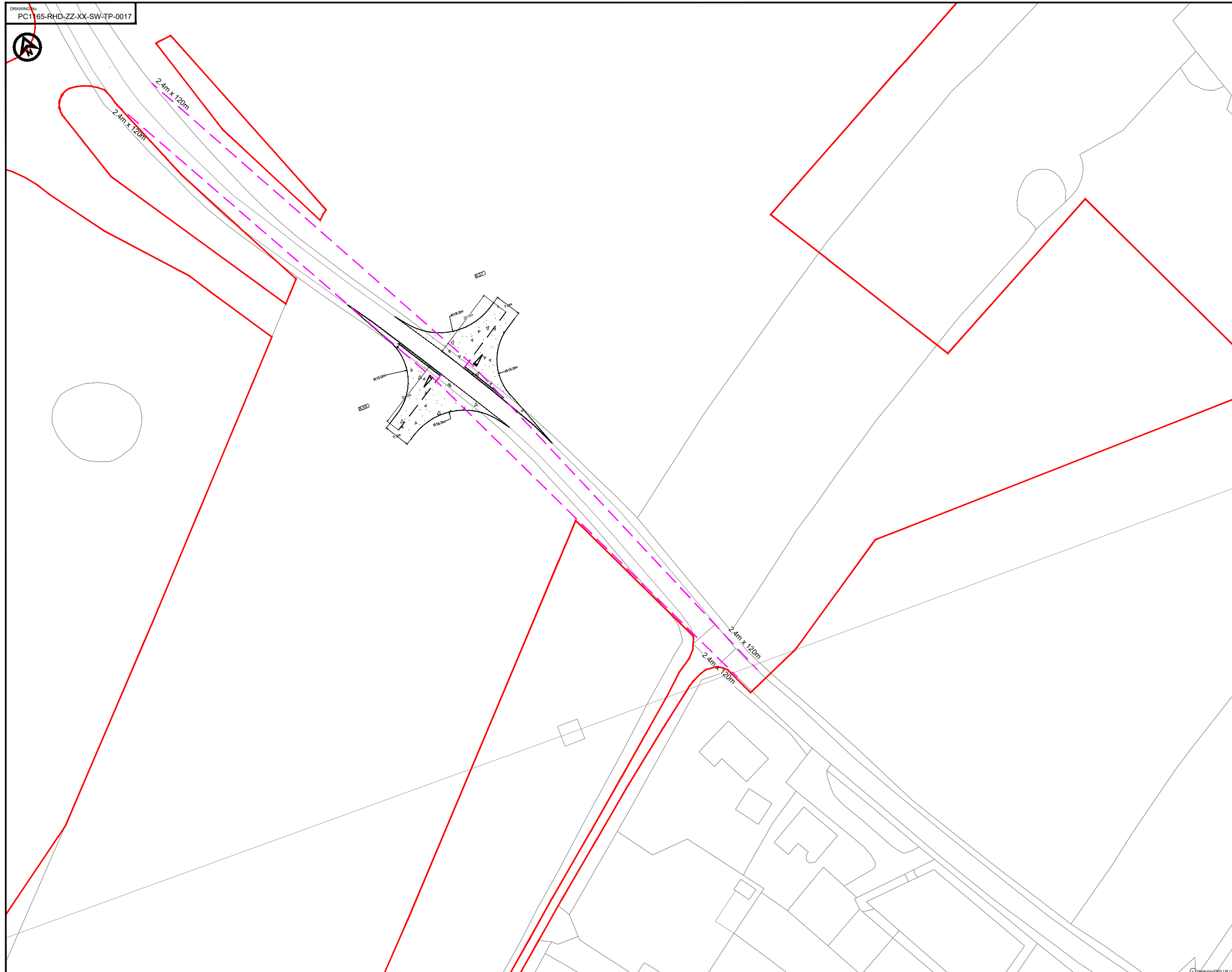

P02	01.05.24	UPDATED WORK AREA AND ORDER LIMITS	AA	SKT	SKT
P01	05.05.23	FIRST ISSUE	CB	SKT	SKT
REV	DATE	DESCRIPTION	BY	CHK	APP

REVISIONS

CLIENT

**MORECAMBE OFFSHORE WIND FARM LTD AND MORGAN OFFSHORE WINDFARM LTD**

**PROJECT**  
MORGAN AND MORECAMBE OFFSHORE WIND FARMS TRANSMISSION ASSETS

**TITLE**  
ACCESS A36 AND A37 GENERAL ARRANGEMENT



DRAWN	CB	CHECKED	SKT	APPROVED	SKT
DATE	05.05.23	SCALE AT A3	1:1000	AUTOCAD REF.	
DRAWING No.	PC1165-RHD-ZZ-XX-SW-TP-0017				REVISION
CLIENT DWG No.					P02

DRAWING No.  
PC1165-RHD-ZZ-XX-SW-TP-0059



**NOTES**  
 1. Do not scale from this drawing, all dimensions are in metres unless noted otherwise.  
 2. This drawing has been based upon Ordnance Survey Maps and Royal HaskoningDHV can not guarantee the accuracy of data.

**KEY**

- EXISTING ARRANGEMENT
- PROPOSED ACCESS BOUNDARY/ROAD MARKINGS
- MORGAN AND MORECAMBE ORDER LIMITS

**VEHICLE TRACKING**

Max Legal Length (UK) Articulated Vehicle (16.5m)  
 Overall Length 16.500m  
 Overall Width 2.550m  
 Overall Body Height 3.681m  
 Min Body Ground Clearance 0.411m  
 Max Track Width 2.500m  
 Lock to lock time 6.00s  
 Kerb to Kerb Turning Radius 6.530m

- VEHICLE BODY SWEEP PATH (FORWARD GEAR)
- VEHICLE CHASSIS SWEEP PATH

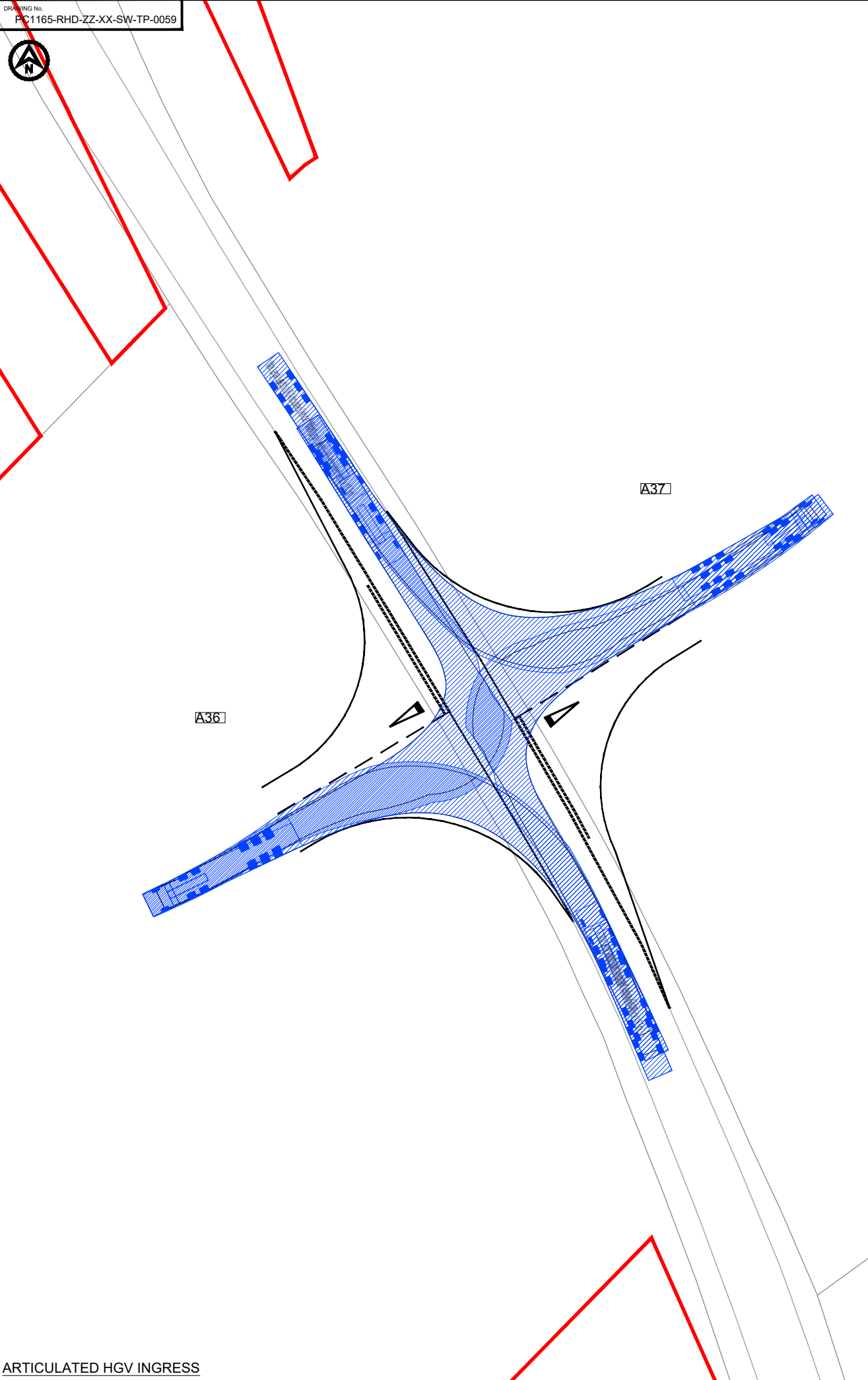

ARTICULATED HGV INGRESS

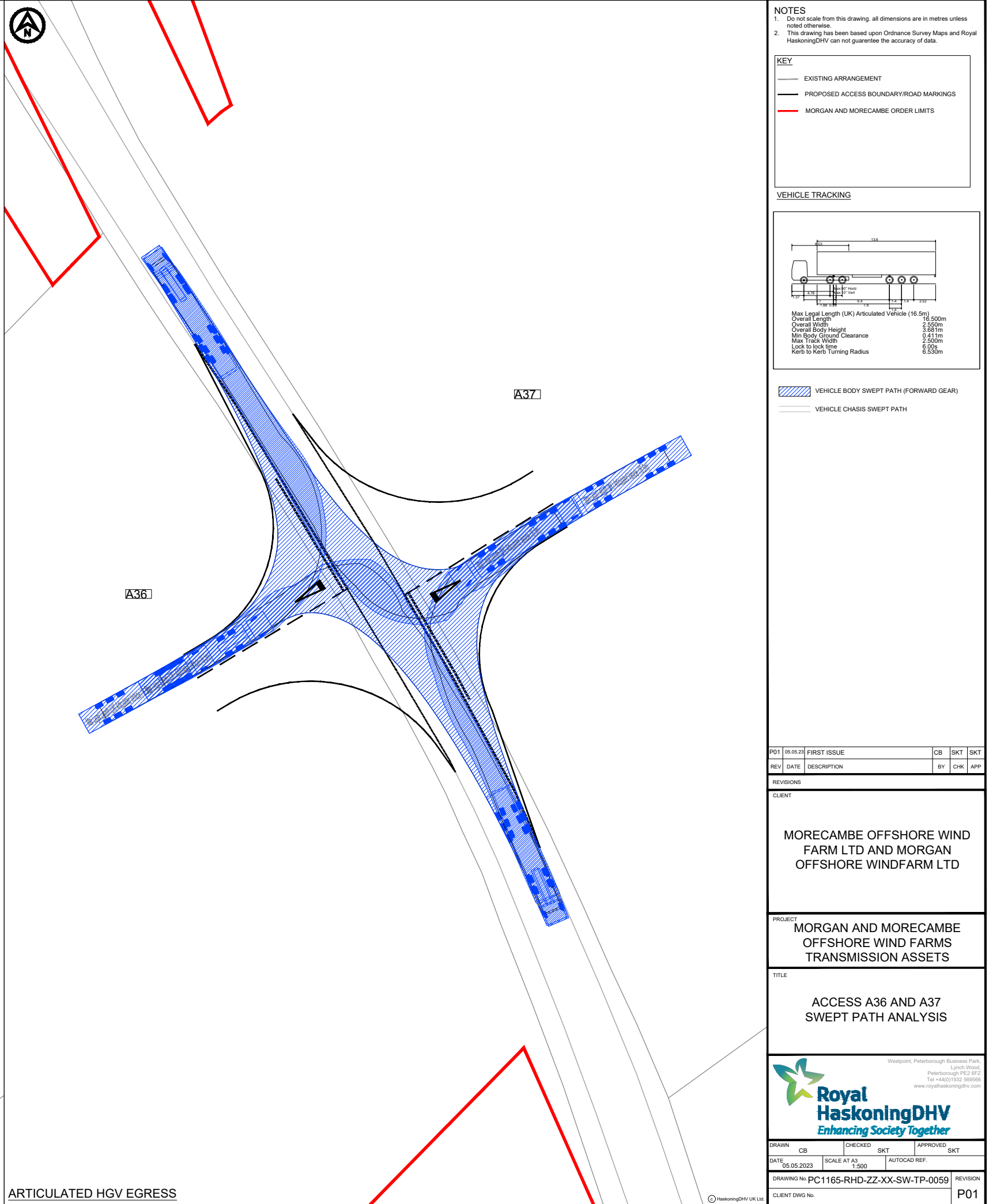

ARTICULATED HGV EGRESS

REV	DATE	DESCRIPTION	BY	CHK	APP
P01	05.05.23	FIRST ISSUE	CB	SKT	SKT

**REVISIONS**

**CLIENT**

MORECAMBE OFFSHORE WIND FARM LTD AND MORGAN OFFSHORE WINDFARM LTD

**PROJECT**

MORGAN AND MORECAMBE OFFSHORE WIND FARMS TRANSMISSION ASSETS

**TITLE**

ACCESS A36 AND A37 SWEEP PATH ANALYSIS



DRAWN	CHECKED	APPROVED
CB	SKT	SKT
DATE	SCALE AT A3	AUTOCAD REF.
05.05.2023	1:500	
DRAWING No. PC1165-RHD-ZZ-XX-SW-TP-0059	REVISION	
CLIENT DWG No.		P01

DRAWING No.  
PC1165-RHD-ZZ-XX-SW-TP-0019



- NOTES**
1. Do not scale from this drawing, all dimensions are in metres unless noted otherwise.
  2. This drawing has been based upon Ordnance Survey Maps and Royal HaskoningDHV can not guarantee the accuracy of data.
  3. X-Distance - the set back from the nearest edge of the carriageway from which the access will be taken
  4. Y-Distance - the SSD measured along the nearest edge of the carriageway to its intersection with the centreline of the access.
  5. All vegetation to be cleared/trimmed within identified visibility envelope and thereafter maintained in accordance with Local Highway Authority maintenance practices.

- KEY**
- EXISTING ARRANGEMENT
  - PROPOSED ACCESS BOUNDARY/ROAD MARKINGS
  - - - VISIBILITY SPLAY FOR ASSUMED JUNCTION LOCATION
  - MORGAN AND MORECAMBE ORDER LIMITS
  - FULL DEPTH CARRIAGEWAY CONSTRUCTION WITH BOUND SURFACE

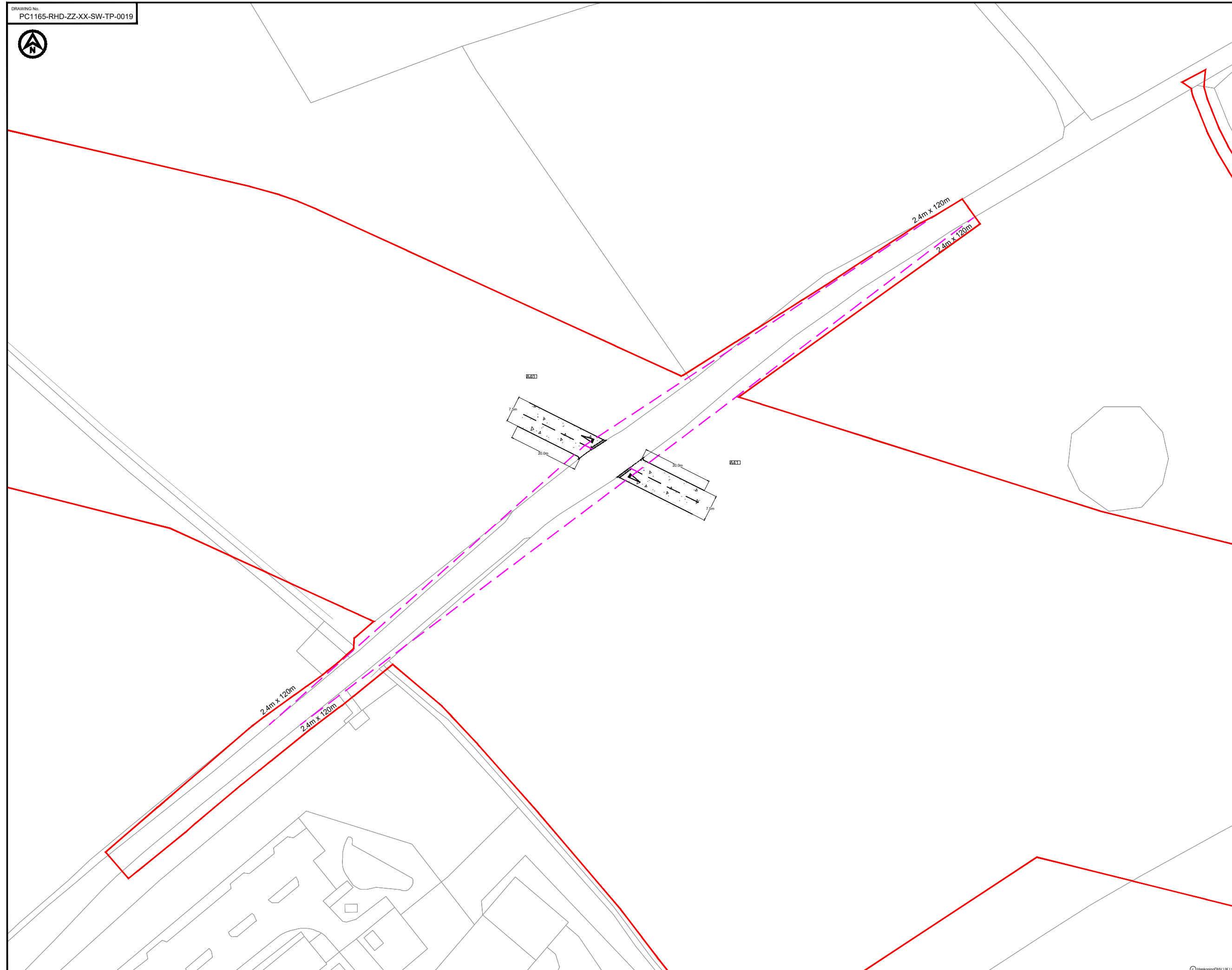

PO2	02.05.24	UPDATED WORK AREA AND ORDER LIMITS	AA	SKT	SKT
P01	05.05.23	FIRST ISSUE	CB	SKT	SKT
REV	DATE	DESCRIPTION	BY	CHK	APP

REVISIONS

CLIENT

**MORECAMBE OFFSHORE WIND FARM LTD AND MORGAN OFFSHORE WINDFARM LTD**

**PROJECT**  
MORGAN AND MORECAMBE OFFSHORE WIND FARMS TRANSMISSION ASSETS

**TITLE**  
CROSSING A40 AND A41 GENERAL ARRANGEMENT



DRAWN	CB	CHECKED	SKT	APPROVED	SKT
DATE	05.05.23	SCALE AT A3	1:1000	AUTOCAD REF.	
DRAWING No.	PC1165-RHD-ZZ-XX-SW-TP-0019			REVISION	
CLIENT DWG No.					P02

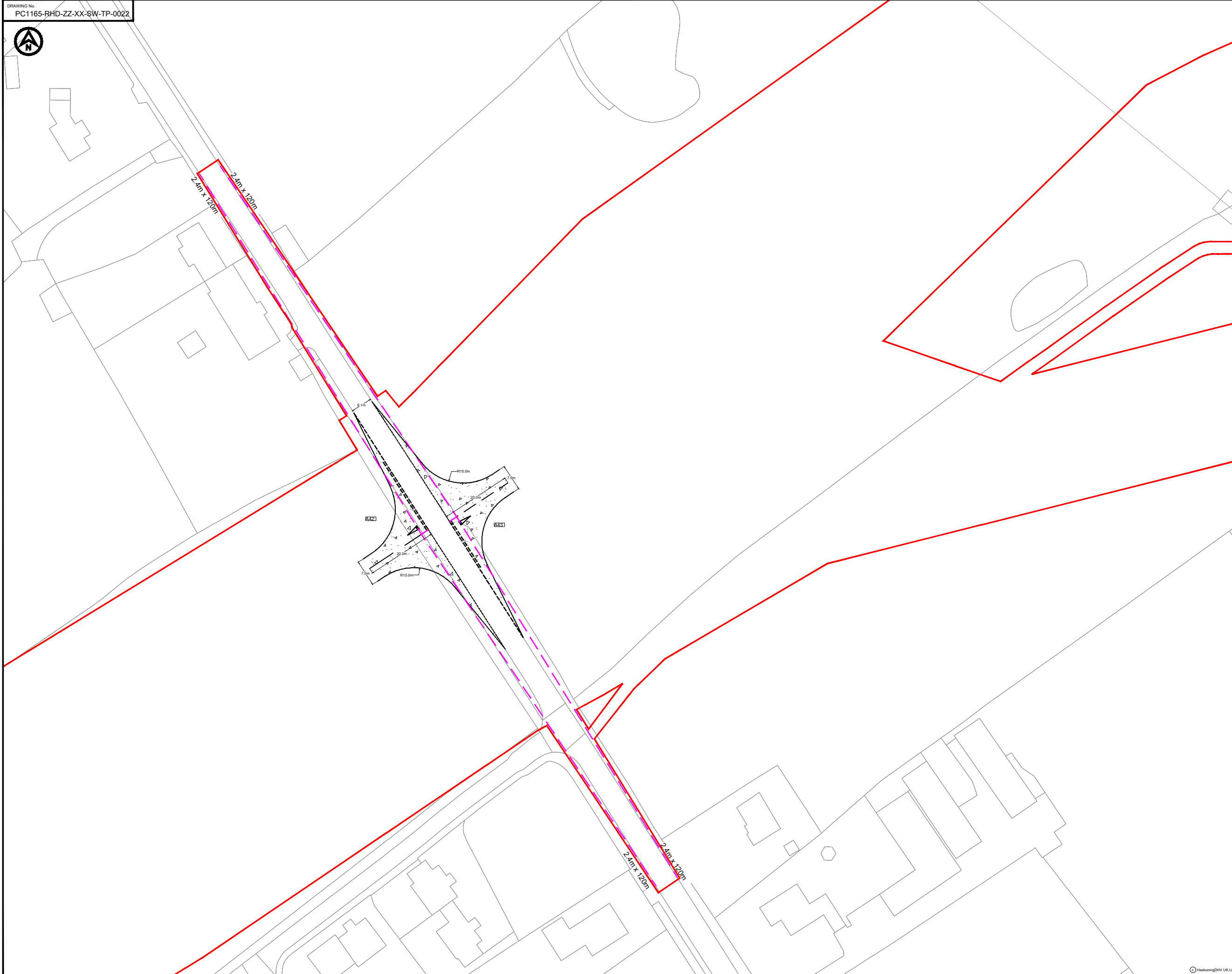

- NOTES**
1. Do not scale from this drawing, all dimensions are in metres unless noted otherwise.
  2. This drawing has been based upon Ordnance Survey Maps and Royal HaskoningDHV can not guarantee the accuracy of data.
  3. X-Distance - the set back from the nearest edge of the carriageway from which the access will be taken
  4. Y-Distance - the SSD measured along the nearest edge of the carriageway to its intersection with the centreline of the access.
  5. All vegetation to be cleared/trimmed within identified visibility envelope and thereafter maintained in accordance with Local Highway Authority maintenance practices.

- KEY**
- EXISTING ARRANGEMENT
  - PROPOSED ACCESS BOUNDARY/ROAD MARKINGS
  - VISIBILITY SPLAY FOR ASSUMED JUNCTION LOCATION
  - MORGAN AND MORECAMBE ORDER LIMITS
  - FULL DEPTH CARRIAGEWAY CONSTRUCTION WITH BOUND SURFACE

P02	02.05.24	UPDATED WORK AREA AND ORDER LIMITS	AA	SKT	SKT
P01	05.05.23	FIRST ISSUE	CB	SKT	SKT
REV	DATE	DESCRIPTION	BY	CHK	APP

REVISIONS

CLIENT

**MORECAMBE OFFSHORE WIND FARM LTD AND MORGAN OFFSHORE WINDFARM LTD**

**MORGAN AND MORECAMBE OFFSHORE WIND FARMS TRANSMISSION ASSETS**

**ACCESS A42 AND A43 GENERAL ARRANGEMENT**



DRAWN	CB	CHECKED	SKT	APPROVED	SKT
DATE	05.05.23	SCALE AT A3	1:1000	AUTOCAD REF.	
DRAWING No.	PC1165-RHD-ZZ-XX-SW-TP-0022				REVISION
CLIENT DWG No.					P02

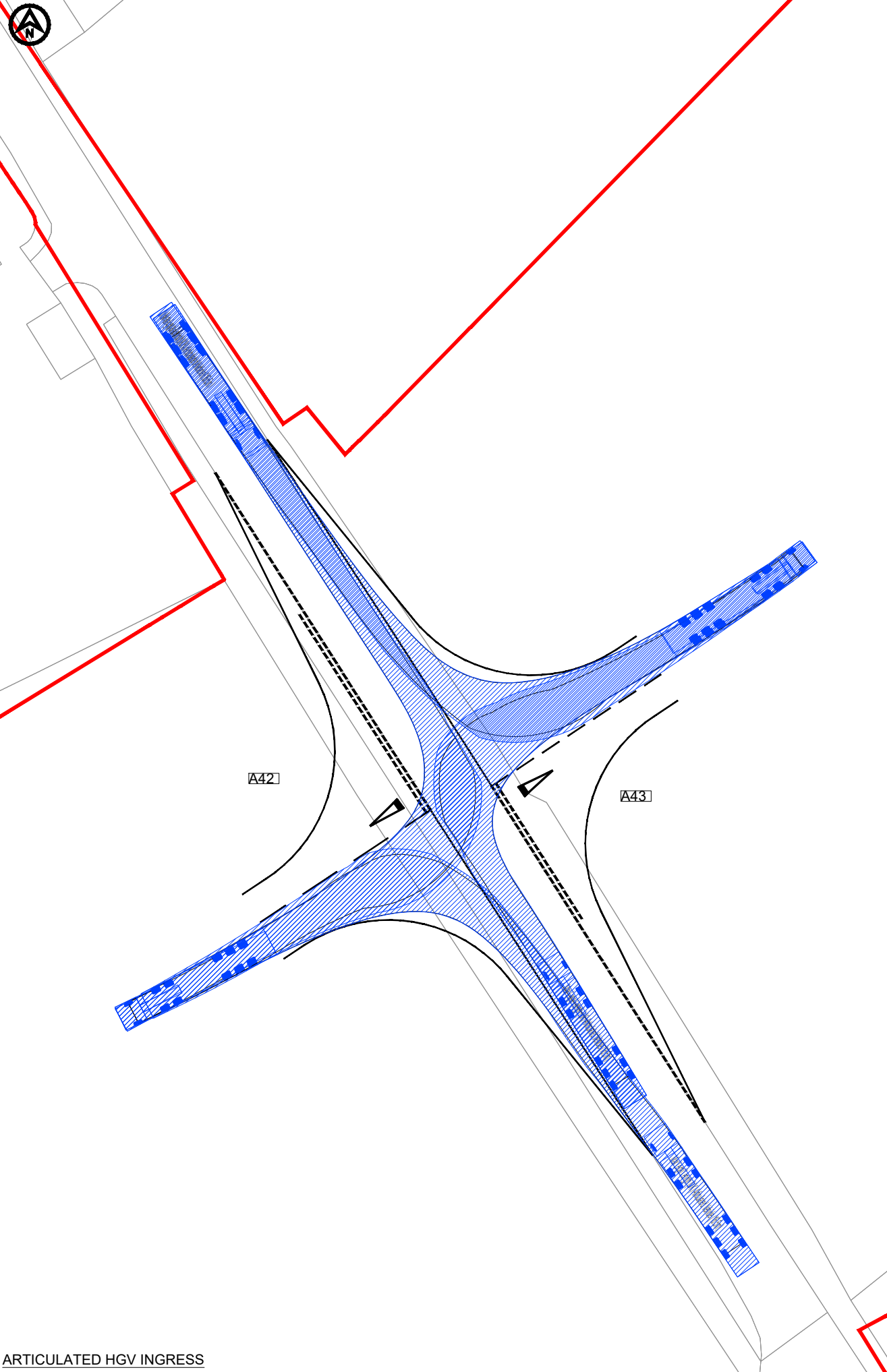

ARTICULATED HGV INGRESS

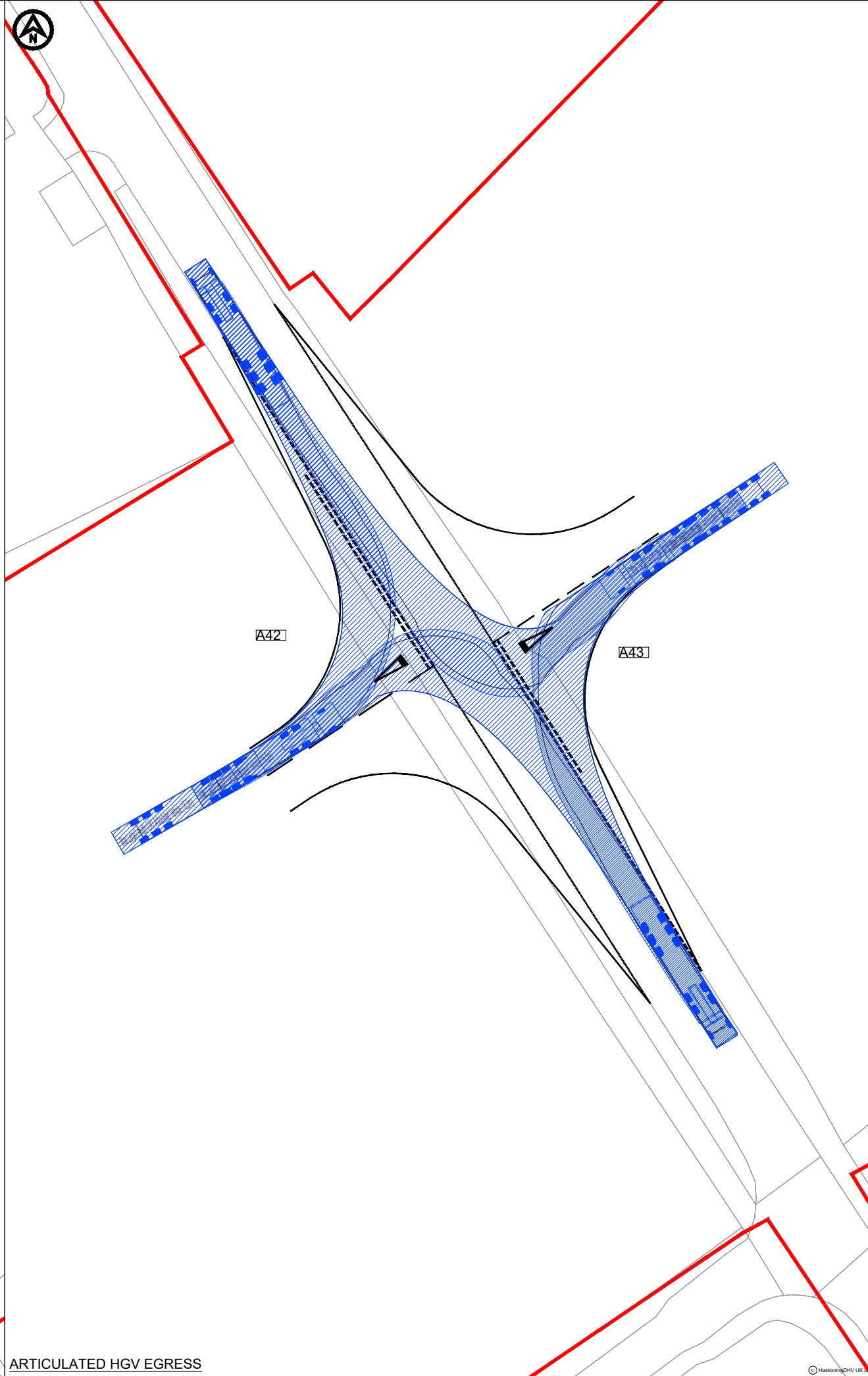

ARTICULATED HGV EGRESS

**NOTES**  
 1. Do not scale from this drawing, all dimensions are in metres unless noted otherwise.  
 2. This drawing has been based upon Ordnance Survey Maps and Royal HaskoningDHV can not guarantee the accuracy of data.

**KEY**

	EXISTING ARRANGEMENT
	PROPOSED ACCESS BOUNDARY/ROAD MARKINGS
	MORGAN AND MORECAMBE ORDER LIMITS

**VEHICLE TRACKING**

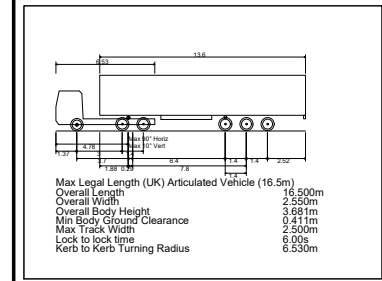

	VEHICLE BODY SWEEP PATH (FORWARD GEAR)
	VEHICLE CHASSIS SWEEP PATH

P01	05.05.23	FIRST ISSUE	CB	SKT	SKT
REV	DATE	DESCRIPTION	BY	CHK	APP

**REVISIONS**

**CLIENT**

MORECAMBE OFFSHORE WIND FARM LTD AND MORGAN OFFSHORE WINDFARM LTD

PROJECT  
MORGAN AND MORECAMBE OFFSHORE WIND FARMS TRANSMISSION ASSETS

**TITLE**

ACCESS A42 AND A43 SWEEP PATH ANALYSIS



DRAWN	CB	CHECKED	SKT	APPROVED	SKT
DATE	05.05.2023	SCALE AT A3	1:500	AUTOCAD REF.	
DRAWING No.	PC1165-RHD-ZZ-XX-SW-TP-0060				REVISION
CLIENT DWG No.					P01

DRAWING No.  
PC1165-RHD-ZZ-XX-SW-TP-0023



- NOTES**
1. Do not scale from this drawing, all dimensions are in metres unless noted otherwise.
  2. This drawing has been based upon Ordnance Survey Maps and Royal HaskoningDHV can not guarantee the accuracy of data.
  3. X-distance - the set back from the nearest edge of the carriageway from which the access will be taken
  4. Y-Distance - the SSD measured along the nearest edge of the carriageway to its intersection with the centreline of the access.
  5. All vegetation to be cleared/trimmed within identified visibility envelope and thereafter maintained in accordance with Local Highway Authority maintenance practices.

- KEY**
- EXISTING ARRANGEMENT
  - PROPOSED ACCESS BOUNDARY/ROAD MARKINGS
  - - - VISIBILITY SPLAY FOR ASSUMED JUNCTION LOCATION
  - MORGAN AND MORECAMBE ORDER LIMITS
  - FULL DEPTH CARRIAGEWAY CONSTRUCTION WITH BOUND SURFACE



REV	DATE	DESCRIPTION	BY	CHK	APP
P03	03.05.24	UPDATED WORK AREA AND ORDER LIMITS	AA	SKT	SKT
P02	15.05.23	UPDATES IN LINE WITH COMMENTS	CB	SKT	SKT
P01	05.05.23	FIRST ISSUE	CB	SKT	SKT

REVISIONS

CLIENT

**MORECAMBE OFFSHORE WIND FARM LTD AND MORGAN OFFSHORE WINDFARM LTD**

**PROJECT**  
MORGAN AND MORECAMBE OFFSHORE WIND FARMS TRANSMISSION ASSETS

**TITLE**  
CROSSING A44 AND A45 GENERAL ARRANGEMENT



DRAWN	CHECKED	APPROVED
CB	SKT	SKT
DATE	SCALE AT A3	AUTOCAD REF.
05.05.23	1:1000	
DRAWING No.	PC1165-RHD-ZZ-XX-SW-TP-0023	REVISION
CLIENT DWG No.		P03

DRAWING No.  
PC1165-RHD-ZZ-XX-SW-TP-0024

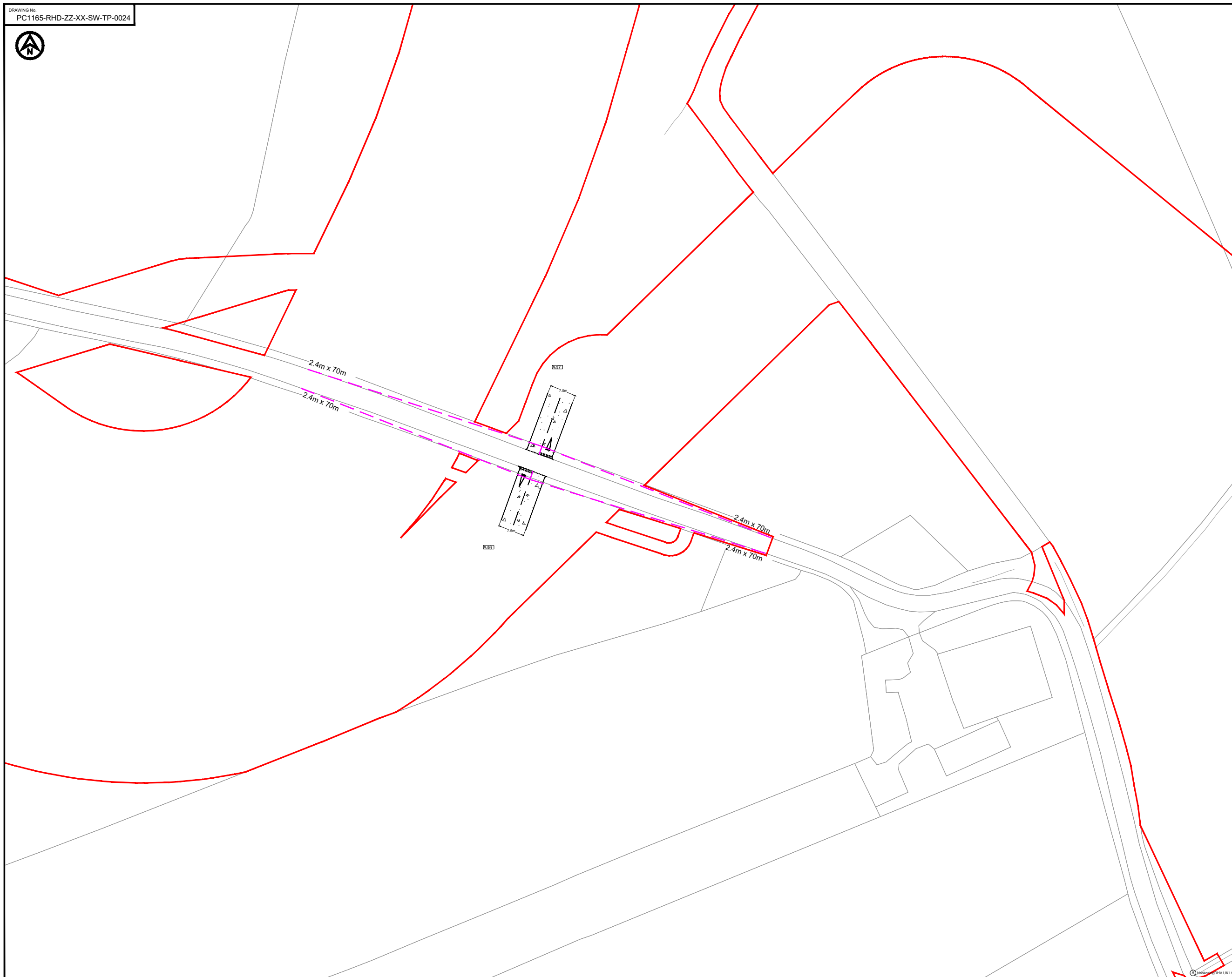

- NOTES**
1. Do not scale from this drawing, all dimensions are in metres unless noted otherwise.
  2. This drawing has been based upon Ordnance Survey Maps and Royal HaskoningDHV can not guarantee the accuracy of data.
  3. X-distance - the set back from the nearest edge of the carriageway from which the access will be taken
  4. Y-Distance - the SSD measured along the nearest edge of the carriageway to its intersection with the centreline of the access.
  5. All vegetation to be cleared/trimmed within identified visibility envelope and thereafter maintained in accordance with Local Highway Authority maintenance practices.

**KEY**

- EXISTING ARRANGEMENT
- PROPOSED ACCESS BOUNDARY/ROAD MARKINGS
- - - VISIBILITY SPLAY FOR ASSUMED JUNCTION LOCATION
- MORGAN AND MORECAMBE ORDER LIMITS
- FULL DEPTH CARRIAGEWAY CONSTRUCTION WITH BOUND SURFACE

REV	DATE	DESCRIPTION	BY	CHK	APP
P03	02.05.24	UPDATED WORK AREA AND ORDER LIMITS	AA	SKT	SKT
P02	15.05.23	UPDATED IN LINE WITH COMMENTS	CB	SKT	SKT
P01	05.05.23	FIRST ISSUE	CB	SKT	SKT

REVISIONS

CLIENT

**MORECAMBE OFFSHORE WIND FARM LTD AND MORGAN OFFSHORE WINDFARM LTD**

**PROJECT**  
MORGAN AND MORECAMBE OFFSHORE WIND FARMS TRANSMISSION ASSETS

**TITLE**  
CROSSING A46 AND A47 GENERAL ARRANGEMENT



DRAWN	CHECKED	APPROVED
CB	SKT	SKT
DATE	SCALE AT A3	AUTOCAD REF.
05.05.23	1:1000	
DRAWING No.	PC1165-RHD-ZZ-XX-SW-TP-0024	REVISION
CLIENT DWG No.		P03



- NOTES**
1. Do not scale from this drawing, all dimensions are in metres unless noted otherwise.
  2. This drawing has been based upon Ordnance Survey Maps and Royal HaskoningDHV can not guarantee the accuracy of data.
  3. X-distance - the set back from the nearest edge of the carriageway from which the access will be taken
  4. Y-Distance - the SSD measured along the nearest edge of the carriageway to its intersection with the centreline of the access.
  5. All vegetation to be cleared/trimmed within identified visibility envelope and thereafter maintained in accordance with Local Highway Authority maintenance practices.
  6. Requirement for diverge tapers to be determined once daily flows into access established.

**KEY**

- EXISTING ARRANGEMENT
- PROPOSED ACCESS BOUNDARY/ROAD MARKINGS
- - - VISIBILITY SPLAY FOR ASSUMED JUNCTION LOCATION
- MORGAN AND MORECAMBE ORDER LIMITS
- FULL DEPTH CARRIAGEWAY CONSTRUCTION WITH BOUND SURFACE
- PROPOSED NEW UNCONTROLLED TACTILE CROSS OVER

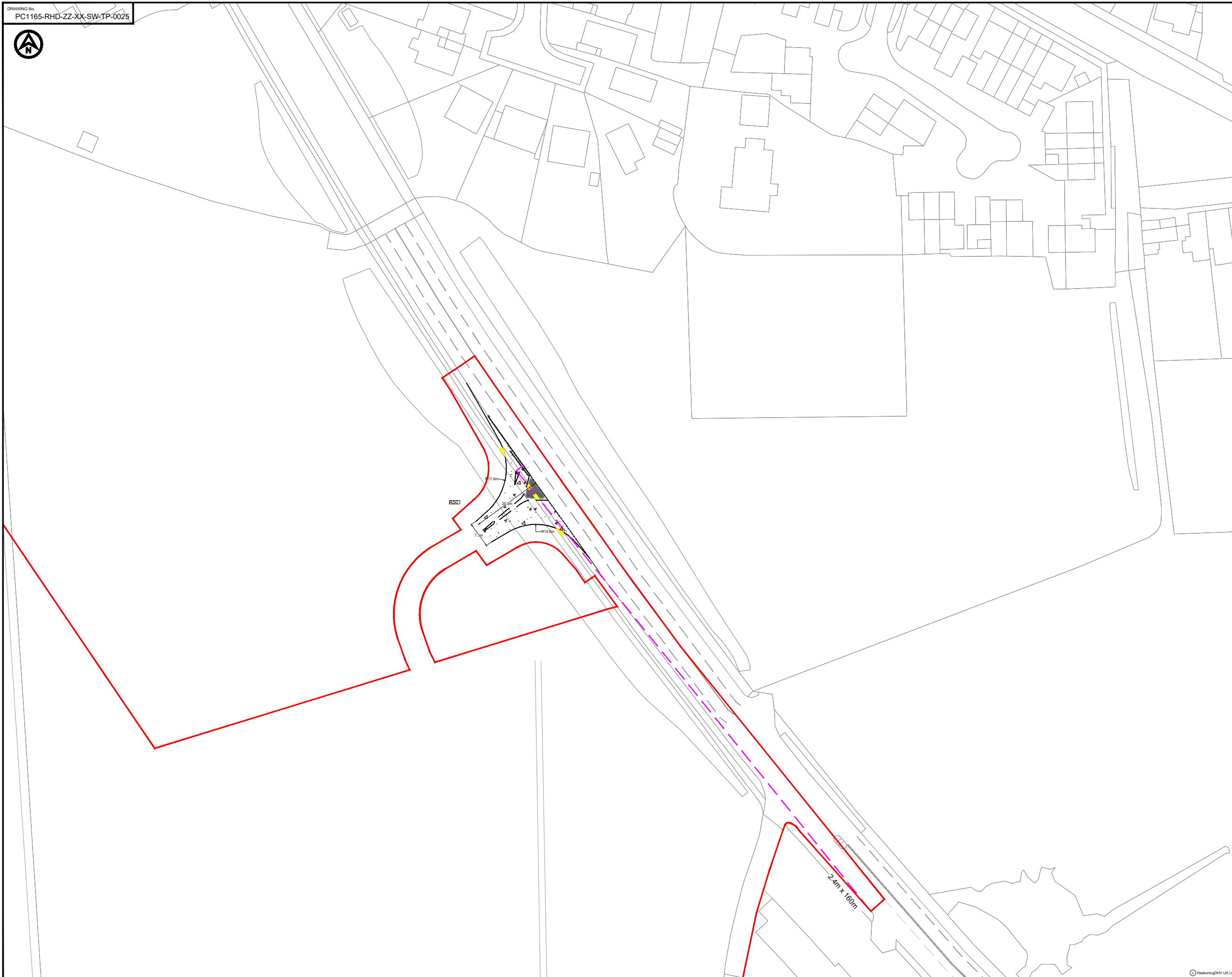

P02	03.05.24	UPDATED WORK AREA AND ORDER LIMITS	AA	SKT	SKT
P01	05.05.23	FIRST ISSUE	CB	SKT	SKT
REV	DATE	DESCRIPTION	BY	CHK	APP

REVISIONS

CLIENT

**MORECAMBE OFFSHORE WIND FARM LTD AND MORGAN OFFSHORE WINDFARM LTD**

**PROJECT**  
MORGAN AND MORECAMBE OFFSHORE WIND FARMS TRANSMISSION ASSETS

**TITLE**  
ACCESS A50  
GENERAL ARRANGEMENT



DRAWN	CB	CHECKED	SKT	APPROVED	SKT
DATE	05.05.23	SCALE AT A3	1:1000	AUTOCAD REF.	
DRAWING No.	PC1165-RHD-ZZ-XX-SW-TP-0025				REVISION
CLIENT DWG No.					P02





- NOTES**
1. Do not scale from this drawing, all dimensions are in metres unless noted otherwise.
  2. This drawing has been based upon Ordnance Survey Maps and Royal HaskoningDHV can not guarantee the accuracy of data.
  3. X-Distance - the set back from the nearest edge of the carriageway from which the access will be taken
  4. Y-Distance - the SSD measured along the nearest edge of the carriageway to its intersection with the centreline of the access.
  5. All vegetation to be cleared/trimmed within identified visibility envelope and thereafter maintained in accordance with Local Highway Authority maintenance practices.
  6. Requirement for diverge tapers to be determined once daily flows into access established.

**KEY**

- EXISTING ARRANGEMENT
- PROPOSED ACCESS BOUNDARY/ROAD MARKINGS
- MORGAN AND MORECAMBE ORDER LIMITS
- PROPOSED NEW UNCONTROLLED TACTILE CROSS OVER

**VEHICLE TRACKING**

Max Legal Length (UK) Articulated Vehicle (16.5m)  
 Overall Length 16.500m  
 Overall Width 2.550m  
 Overall Body Height 3.681m  
 Min Body Ground Clearance 0.411m  
 Max Track Width 2.500m  
 Lock to lock time 6.00s  
 Kerb to Kerb Turning Radius 6.530m

- ▨ VEHICLE BODY SWEEP PATH (FORWARD GEAR)
- VEHICLE CHASSIS SWEEP PATH

REV	DATE	DESCRIPTION	BY	CHK	APP
P01	05.05.23	FIRST ISSUE	CB	SKT	SKT

REVISIONS

CLIENT

**MORECAMBE OFFSHORE WIND FARM LTD AND MORGAN OFFSHORE WINDFARM LTD**

PROJECT

**MORGAN AND MORECAMBE OFFSHORE WIND FARMS TRANSMISSION ASSETS**

TITLE

**ACCESS A50 SWEEP PATH ANALYSIS**



DRAWN	CB	CHECKED	SKT	APPROVED	SKT
DATE	05.05.23	SCALE AT A3	1:1000	AUTOCAD REF.	
DRAWING No.	PC1165-RHD-ZZ-XX-SW-TP-0061				REVISION
CLIENT DWG No.					P01

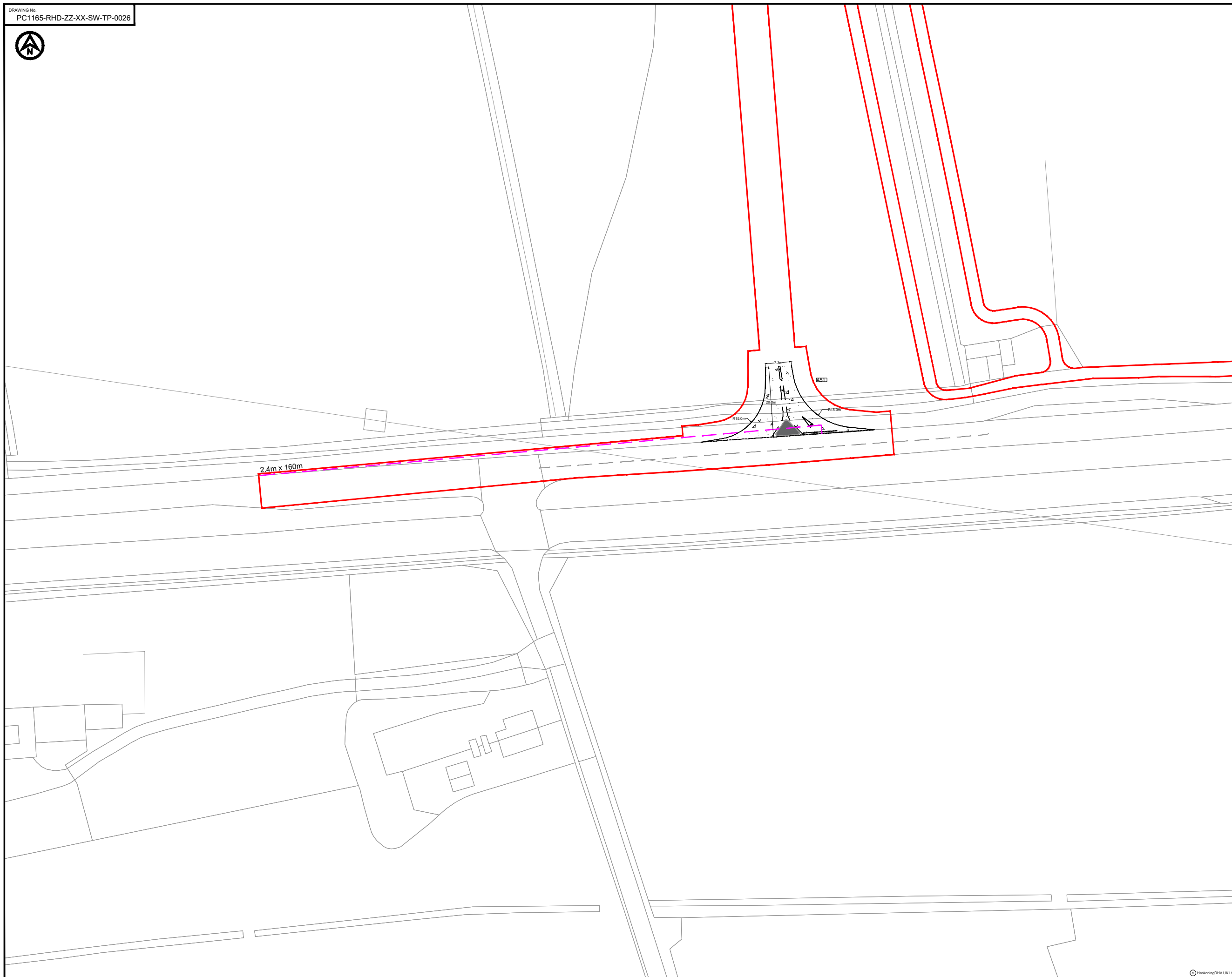

- NOTES**
1. Do not scale from this drawing, all dimensions are in metres unless noted otherwise.
  2. This drawing has been based upon Ordnance Survey Maps and Royal HaskoningDHV can not guarantee the accuracy of data.
  3. X-distance - the set back from the nearest edge of the carriageway from which the access will be taken
  4. Y-Distance - the SSD measured along the nearest edge of the carriageway to its intersection with the centreline of the access.
  5. All vegetation to be cleared/trimmed within identified visibility envelope and thereafter maintained in accordance with Local Highway Authority maintenance practices.
  6. Requirement for diverge tapers to be determined once daily flows into access established.

**KEY**

- EXISTING ARRANGEMENT
- PROPOSED ACCESS BOUNDARY/ROAD MARKINGS
- - - VISIBILITY SPLAY FOR ASSUMED JUNCTION LOCATION
- MORGAN AND MORECAMBE ORDER LIMITS
- ▨ FULL DEPTH CARRIAGEWAY CONSTRUCTION WITH BOUND SURFACE

REV	DATE	DESCRIPTION	BY	CHK	APP
P02	03.05.24	UPDATED WORK AREA AND ORDER LIMITS	AA	SKT	SKT
P01	05.05.23	FIRST ISSUE	CB	SKT	SKT

REVISIONS

CLIENT

**MORECAMBE OFFSHORE WIND FARM LTD AND MORGAN OFFSHORE WINDFARM LTD**

**PROJECT**  
MORGAN AND MORECAMBE OFFSHORE WIND FARMS TRANSMISSION ASSETS

**TITLE**  
ACCESS A51  
GENERAL ARRANGEMENT



DRAWN	CHECKED	APPROVED
CB	SKT	SKT
DATE	SCALE AT A3	AUTOCAD REF.
05.05.23	1:1000	
DRAWING No.	PC1165-RHD-ZZ-XX-SW-TP-0026	REVISION
CLIENT DWG No.		P02

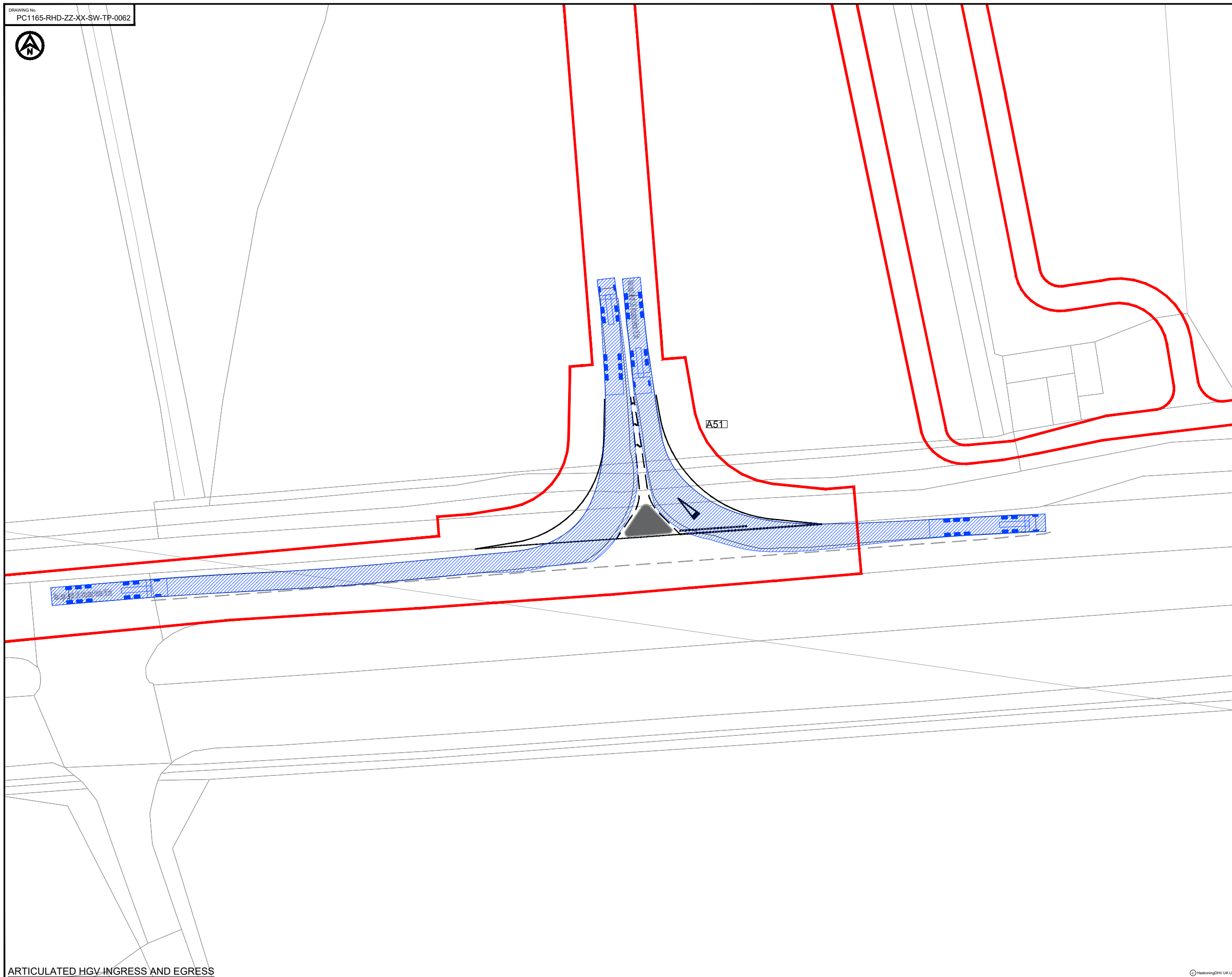

- NOTES**
1. Do not scale from this drawing, all dimensions are in metres unless noted otherwise.
  2. This drawing has been based upon Ordnance Survey Maps and Royal HaskoningDHV can not guarantee the accuracy of data.
  3. X-distance - the set back from the nearest edge of the carriageway from which the access will be taken
  4. Y-Distance - the SSD measured along the nearest edge of the carriageway to its intersection with the centreline of the access.
  5. All vegetation to be cleared/trimmed within identified visibility envelope and thereafter maintained in accordance with Local Highway Authority maintenance practices.
  6. Requirement for diverge tapers to be determined once daily flows into access established.

**KEY**

	EXISTING ARRANGEMENT
	PROPOSED ACCESS BOUNDARY/ROAD MARKINGS
	MORGAN AND MORECAMBE ORDER LIMITS

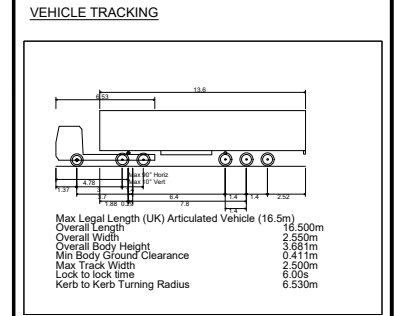

	VEHICLE BODY SWEEP PATH (FORWARD GEAR)
	VEHICLE CHASSIS SWEEP PATH

REV	DATE	DESCRIPTION	BY	CHK	APP
P01	05.05.23	FIRST ISSUE	CB	SKT	SKT

REVISIONS

CLIENT  
**MORECAMBE OFFSHORE WIND FARM LTD AND MORGAN OFFSHORE WINDFARM LTD**

PROJECT  
**MORGAN AND MORECAMBE OFFSHORE WIND FARMS TRANSMISSION ASSETS**

TITLE  
**ACCESS A51 SWEEP PATH ANALYSIS**



DRAWN	CHECKED	APPROVED
CB	SKT	SKT
DATE	SCALE AT A3	AUTOCAD REF.
05.05.23	1:500	
DRAWING No. PC1165-RHD-ZZ-XX-SW-TP-0062	REVISION	
CLIENT DWG No.		P01

DRAWING No.  
PC1165-RHD-ZZ-XX-SW-TP-0028



- NOTES**
1. Do not scale from this drawing, all dimensions are in metres unless noted otherwise.
  2. This drawing has been based upon Ordnance Survey Maps and Royal HaskoningDHV can not guarantee the accuracy of data.
  3. X-distance - the set back from the nearest edge of the carriageway from which the access will be taken
  4. Y-Distance - the SSD measured along the nearest edge of the carriageway to its intersection with the centreline of the access.
  5. All vegetation to be cleared/trimmed within identified visibility envelope and thereafter maintained in accordance with Local Highway Authority maintenance practices.
  6. Requirement for diverge tapers to be determined once daily flows into access established.

- KEY**
- EXISTING ARRANGEMENT
  - PROPOSED ACCESS BOUNDARY/ROAD MARKINGS
  - VISIBILITY SPLAY FOR ASSUMED JUNCTION LOCATION
  - MORGAN AND MORECAMBE ORDER LIMITS
  - FULL DEPTH CARRIAGEWAY CONSTRUCTION WITH BOUND SURFACE
  - PROPOSED NEW UNCONTROLLED TACTILE CROSS OVER

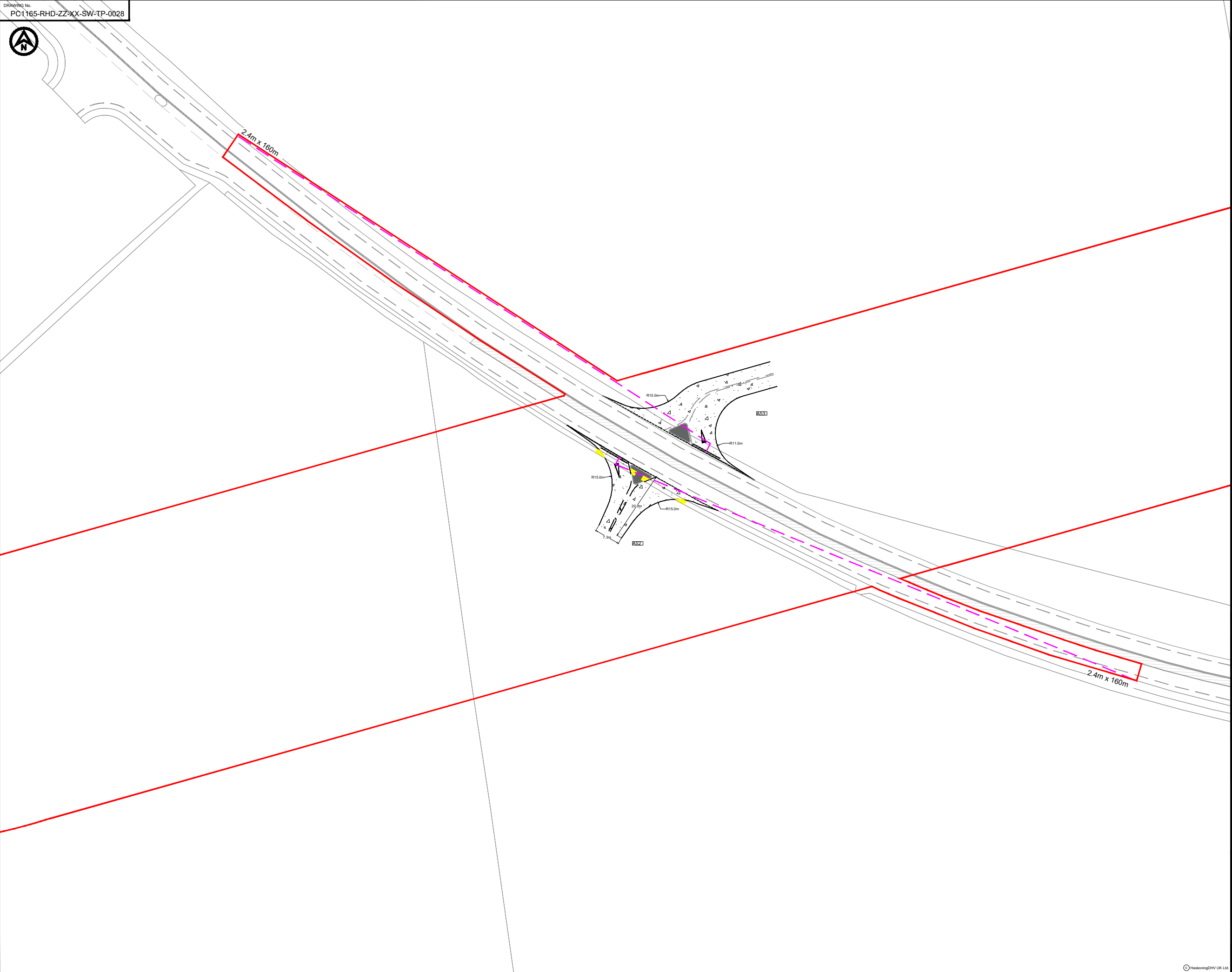

P02	03.05.24	UPDATED WORK AREA AND ORDER LIMITS	AA	SKT	SKT
P01	05.05.23	FIRST ISSUE	CB	SKT	SKT
REV	DATE	DESCRIPTION	BY	CHK	APP

REVISIONS

CLIENT

**MORECAMBE OFFSHORE WIND FARM LTD AND MORGAN OFFSHORE WINDFARM LTD**

**MORGAN AND MORECAMBE OFFSHORE WIND FARMS TRANSMISSION ASSETS**

**ACCESS A52 AND A53 GENERAL ARRANGEMENT**



DRAWN	CHECKED	APPROVED
CB	SKT	SKT
DATE	SCALE AT A3	AUTOCAD REF.
05.05.23	1:1000	
DRAWING No.	PC1165-RHD-ZZ-XX-SW-TP-0028	REVISION
CLIENT DWG No.		P02

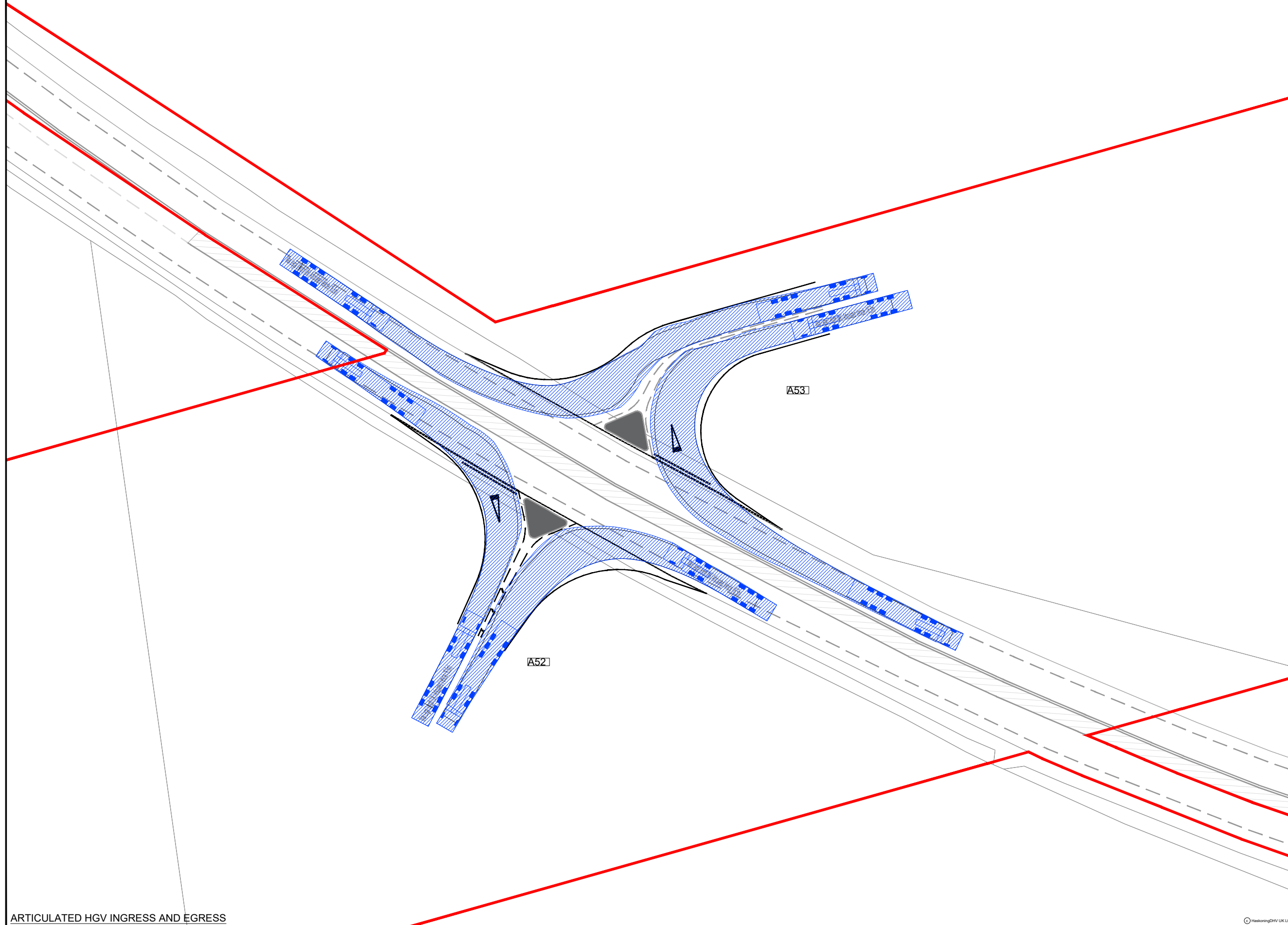

- NOTES**
1. Do not scale from this drawing, all dimensions are in metres unless noted otherwise.
  2. This drawing has been based upon Ordnance Survey Maps and Royal HaskoningDHV can not guarantee the accuracy of data.
  3. X-distance - the set back from the nearest edge of the carriageway from which the access will be taken
  4. Y-Distance - the SSD measured along the nearest edge of the carriageway to its intersection with the centreline of the access.
  5. All vegetation to be cleared/trimmed within identified visibility envelope and thereafter maintained in accordance with Local Highway Authority maintenance practices.
  6. Requirement for diverge tapers to be determined once daily flows into access established.

**KEY**

- EXISTING ARRANGEMENT
- PROPOSED ACCESS BOUNDARY/ROAD MARKINGS
- MORGAN AND MORECAMBE ORDER LIMITS

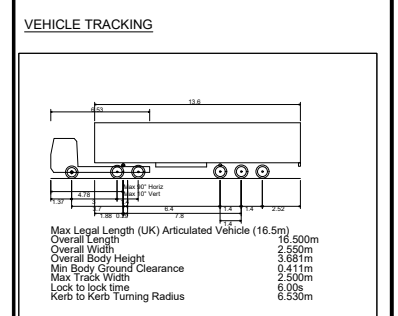

- ▨ VEHICLE BODY SWEEP PATH (FORWARD GEAR)
- VEHICLE CHASSIS SWEEP PATH

REV	DATE	DESCRIPTION	BY	CHK	APP
P01	05.05.23	FIRST ISSUE	CB	SKT	SKT

REVISIONS

CLIENT

**MORECAMBE OFFSHORE WIND FARM LTD AND MORGAN OFFSHORE WINDFARM LTD**

**PROJECT**  
MORGAN AND MORECAMBE OFFSHORE WIND FARMS TRANSMISSION ASSETS

**TITLE**  
ACCESS A52 AND A53 SWEEP PATH ANALYSIS



DRAWN	CHECKED	APPROVED
CB	SKT	SKT
DATE	SCALE AT A3	AUTOCAD REF.
05.05.23	1:500	
DRAWING No.	PC1165-RHD-ZZ-XX-SW-TP-0063	REVISION
CLIENT DWG No.		P01



- NOTES**
1. Do not scale from this drawing, all dimensions are in metres unless noted otherwise.
  2. This drawing has been based upon Ordnance Survey Maps and Royal HaskoningDHV can not guarantee the accuracy of data.
  3. X-Distance - the set back from the nearest edge of the carriageway from which the access will be taken
  4. Y-Distance - the SSD measured along the nearest edge of the carriageway to its intersection with the centreline of the access.
  5. All vegetation to be cleared/trimmed within identified visibility envelope and thereafter maintained in accordance with Local Highway Authority maintenance practices.

**KEY**

- EXISTING ARRANGEMENT
- PROPOSED ACCESS BOUNDARY/ROAD MARKINGS
- - - VISIBILITY SPLAY FOR ASSUMED JUNCTION LOCATION
- MORGAN AND MORECAMBE ORDER LIMITS
- FULL DEPTH CARRIAGEWAY CONSTRUCTION WITH BOUND SURFACE
- PROPOSED NEW FOOTWAY FACILITY TO TIE INTO EXISTING NETWORK
- PROPOSED NEW UNCONTROLLED TACTILE CROSS OVER

REV	DATE	DESCRIPTION	BY	CHK	APP
P03	02.08.24	REMOVED ACCESS A65	AA	SKT	SKT
P02	03.05.24	UPDATED WORK AREA AND ORDER LIMITS	AA	SKT	SKT
P01	05.05.23	FIRST ISSUE	CB	SKT	SKT

REVISIONS

CLIENT

MORECAMBE OFFSHORE WIND FARM LTD AND MORGAN OFFSHORE WINDFARM LTD

PROJECT  
MORGAN AND MORECAMBE OFFSHORE WIND FARMS TRANSMISSION ASSETS

TITLE  
ACCESS A55  
GENERAL ARRANGEMENT



DRAWN	CHECKED	APPROVED
CB	SKT	SKT
DATE	SCALE AT A3	AUTOCAD REF.
05.05.23	1:1000	
DRAWING No.	PC1165-RHD-ZZ-XX-SW-TP-0029	REVISION
CLIENT DWG No.		P03



**NOTES**  
 1. Do not scale from this drawing, all dimensions are in metres unless noted otherwise.  
 2. This drawing has been based upon Ordnance Survey Maps and Royal HaskoningDHV can not guarantee the accuracy of data.

**KEY**

- EXISTING ARRANGEMENT
- PROPOSED ACCESS BOUNDARY/ROAD MARKINGS
- MORGAN AND MORECAMBE ORDER LIMITS
- PROPOSED NEW FOOTWAY FACILITY TO TIE INTO EXISTING NETWORK
- PROPOSED NEW UNCONTROLLED TACTILE CROSS OVER

**VEHICLE TRACKING**

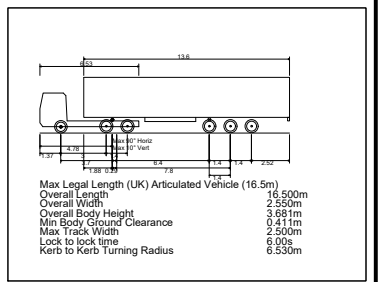

■ VEHICLE BODY SWEEP PATH (FORWARD GEAR)  
 — VEHICLE CHASSIS SWEEP PATH

REV	DATE	DESCRIPTION	BY	CHK	APP
P01	05.05.23	FIRST ISSUE	CB	SKT	SKT

**REVISIONS**

**CLIENT**

MORECAMBE OFFSHORE WIND FARM LTD AND MORGAN OFFSHORE WINDFARM LTD

**PROJECT**

MORGAN AND MORECAMBE OFFSHORE WIND FARMS TRANSMISSION ASSETS



DRAWN	CHECKED	APPROVED
CB	SKT	SKT
DATE: 05.05.2023	SCALE AT A3: 1:500	AUTOCAD REF:
DRAWING No: PC1165-RHD-ZZ-XX-SW-TP-0064		REVISION
CLIENT DWG No:		P01

ARTICULATED HGV INGRESS

ARTICULATED HGV EGRESS

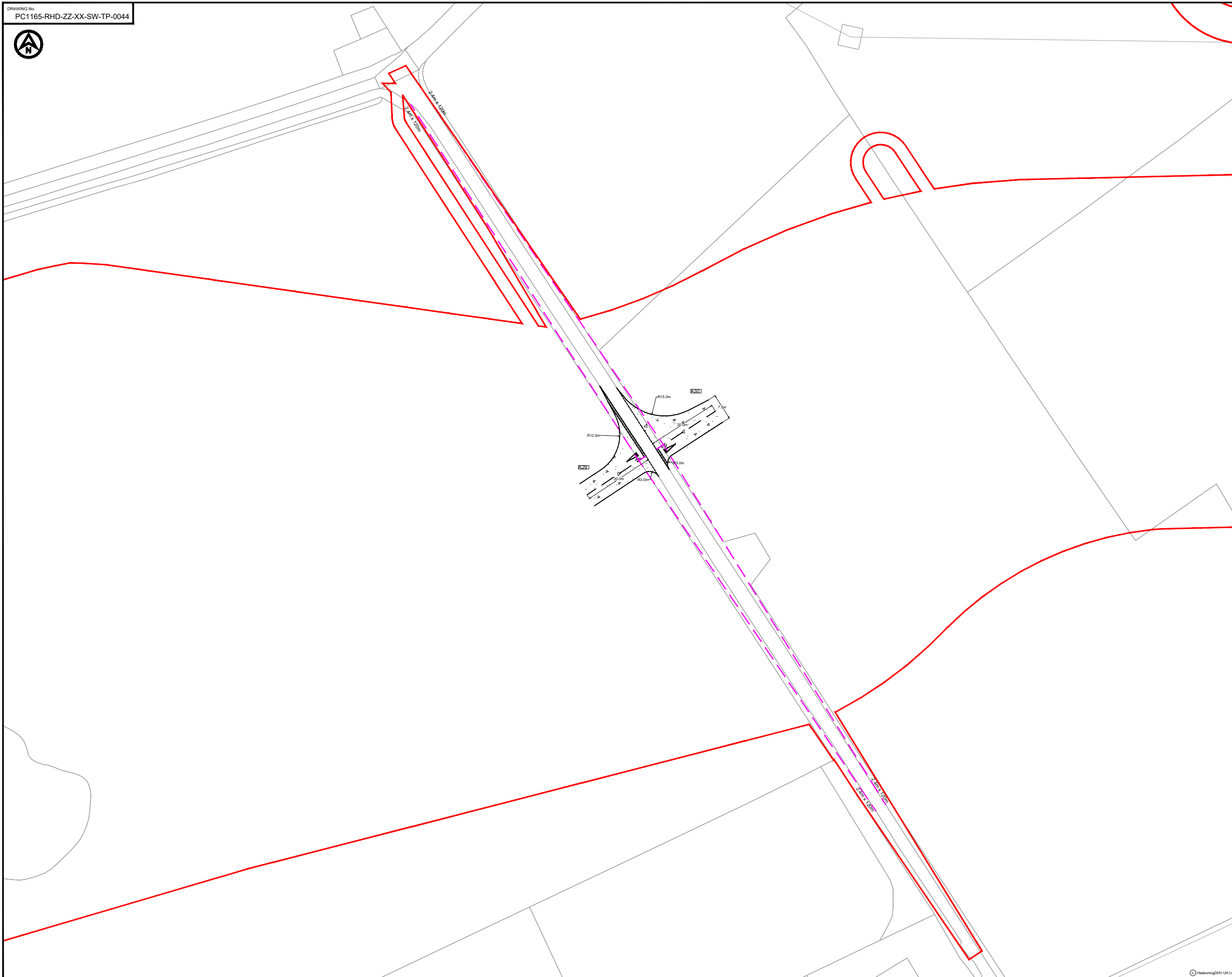

- NOTES**
1. Do not scale from this drawing, all dimensions are in metres unless noted otherwise.
  2. This drawing has been based upon Ordnance Survey Maps and Royal HaskoningDHV can not guarantee the accuracy of data.
  3. X-Distance - the set back from the nearest edge of the carriageway from which the access will be taken
  4. Y-Distance - the SSD measured along the nearest edge of the carriageway to its intersection with the centreline of the access.
  5. All vegetation to be cleared/trimmed within identified visibility envelope and thereafter maintained in accordance with Local Highway Authority maintenance practices.

- KEY**
- EXISTING ARRANGEMENT
  - PROPOSED ACCESS BOUNDARY/ROAD MARKINGS
  - VISIBILITY SPLAY FOR ASSUMED JUNCTION LOCATION
  - MORGAN AND MORECAMBE ORDER LIMITS
  - FULL DEPTH CARRIAGEWAY CONSTRUCTION WITH BOUND SURFACE

REV	DATE	DESCRIPTION	BY	CHK	APP
P03	01.05.24	UPDATED WORK AREA AND ORDER LIMITS	AA	SKT	SKT
P02	12.01.24	UPGRADED TO ACCESSES	AA	SKT	SKT
P01	15.05.23	FIRST ISSUE	CB	SKT	SKT

REVISIONS

CLIENT

MORECAMBE OFFSHORE WIND FARM LTD AND MORGAN OFFSHORE WINDFARM LTD

PROJECT  
MORGAN AND MORECAMBE OFFSHORE WIND FARMS TRANSMISSION ASSETS

TITLE  
ACCESS A29 AND A30 GENERAL ARRANGEMENT



DRAWN	CHECKED	APPROVED
CB	SKT	SKT
DATE	SCALE AT A3	AUTOCAD REF.
15.05.23	1:1000	
DRAWING No.	PC1165-RHD-ZZ-XX-SW-TP-0044	REVISION
CLIENT DWG No.		P03



DRAWING No.  
PC1165-RHD-ZZ-XX-SW-TP-0129



**NOTES**  
 1. Do not scale from this drawing, all dimensions are in metres unless noted otherwise.  
 2. This drawing has been based upon Ordnance Survey Maps and Royal HaskoningDHV can not guarantee the accuracy of data.

**KEY**

- EXISTING ARRANGEMENT
- PROPOSED ACCESS BOUNDARY/ROAD MARKINGS
- MORGAN AND MORECAMBE ORDER LIMITS

**VEHICLE TRACKING**

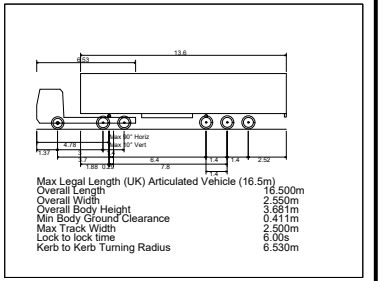

▨ VEHICLE BODY SWEPT PATH (FORWARD GEAR)  
 — VEHICLE CHASSIS SWEPT PATH

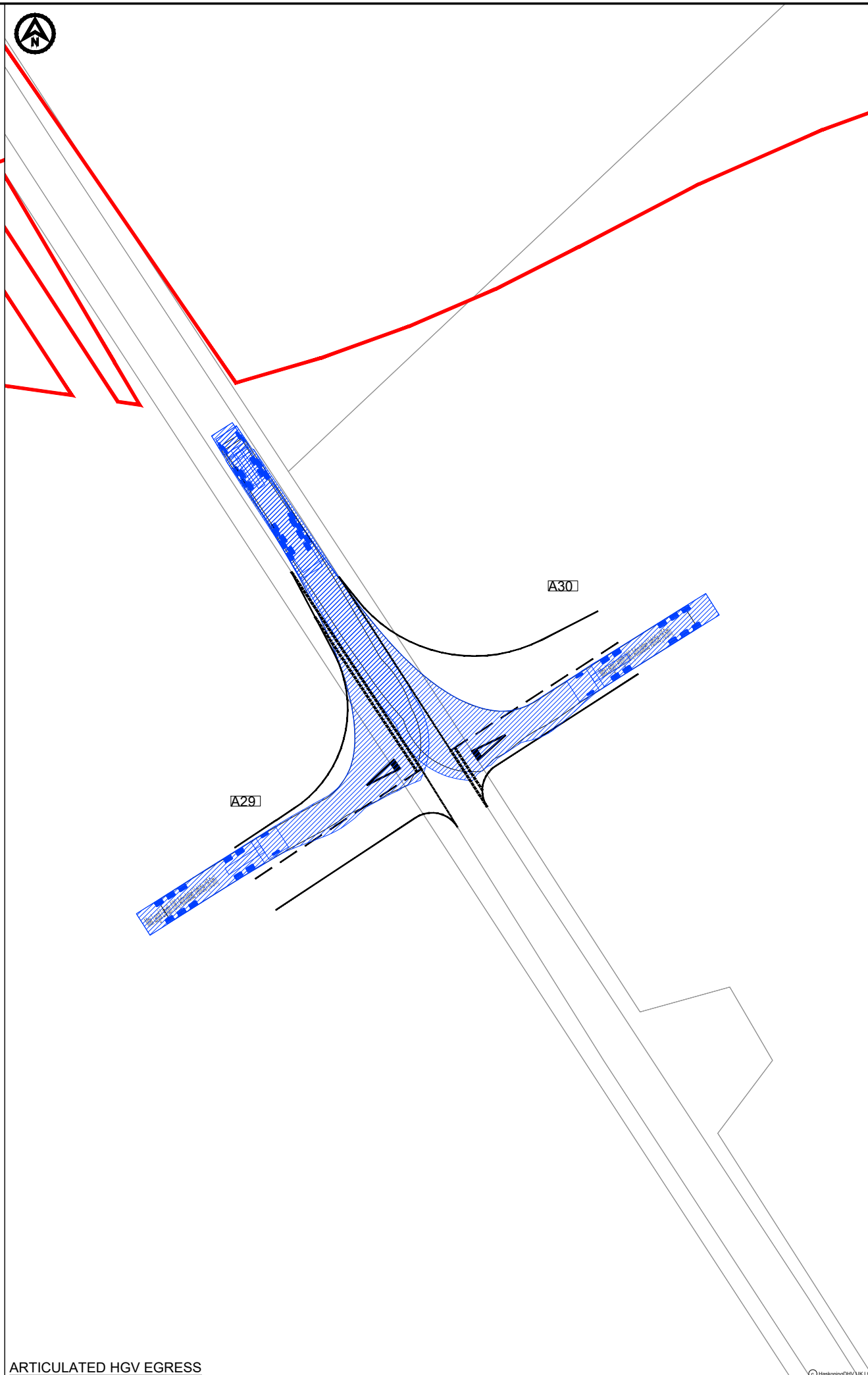
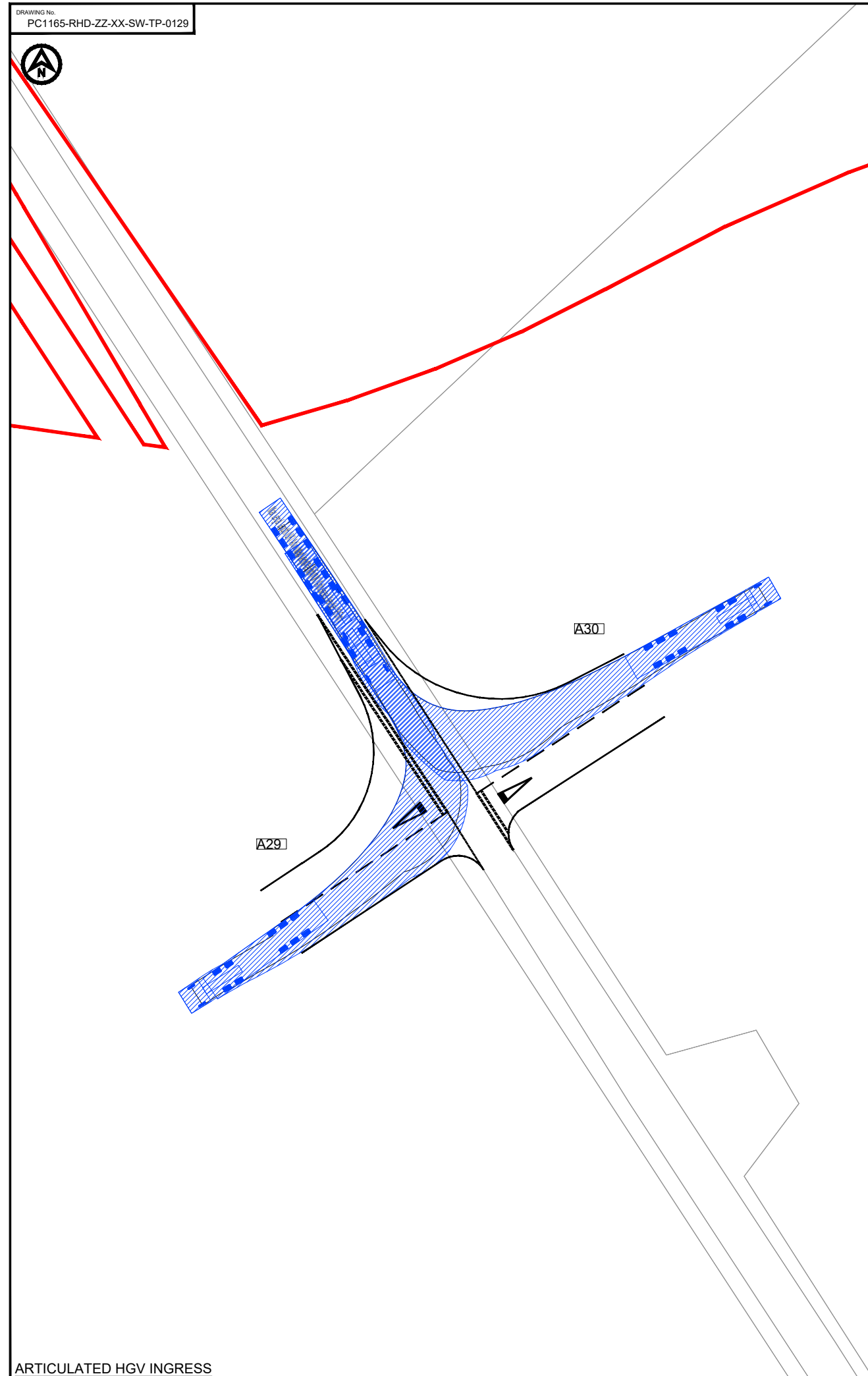

REV	DATE	DESCRIPTION	BY	CHK	APP
P01	12.01.24	FIRST ISSUE	AA	SKT	SKT

**REVISIONS**

CLIENT

**MORECAMBE OFFSHORE WIND FARM LTD AND MORGAN OFFSHORE WINDFARM LTD**

**PROJECT**  
 MORGAN AND MORECAMBE OFFSHORE WIND FARMS TRANSMISSION ASSETS

**TITLE**  
 ACCESS A29 AND A30 SWEPT PATH ANALYSIS



DRAWN	CHECKED	APPROVED
AA	SKT	SKT

DATE: 12.01.2024 SCALE AT A3 VARIES AUTOCAD REF:

DRAWING No. PC1165-RHD-ZZ-XX-SW-TP-0129 REVISION P01

CLIENT DWG No. P01

ARTICULATED HGV INGRESS

ARTICULATED HGV EGRESS

© HaskoningDHV UK Ltd.

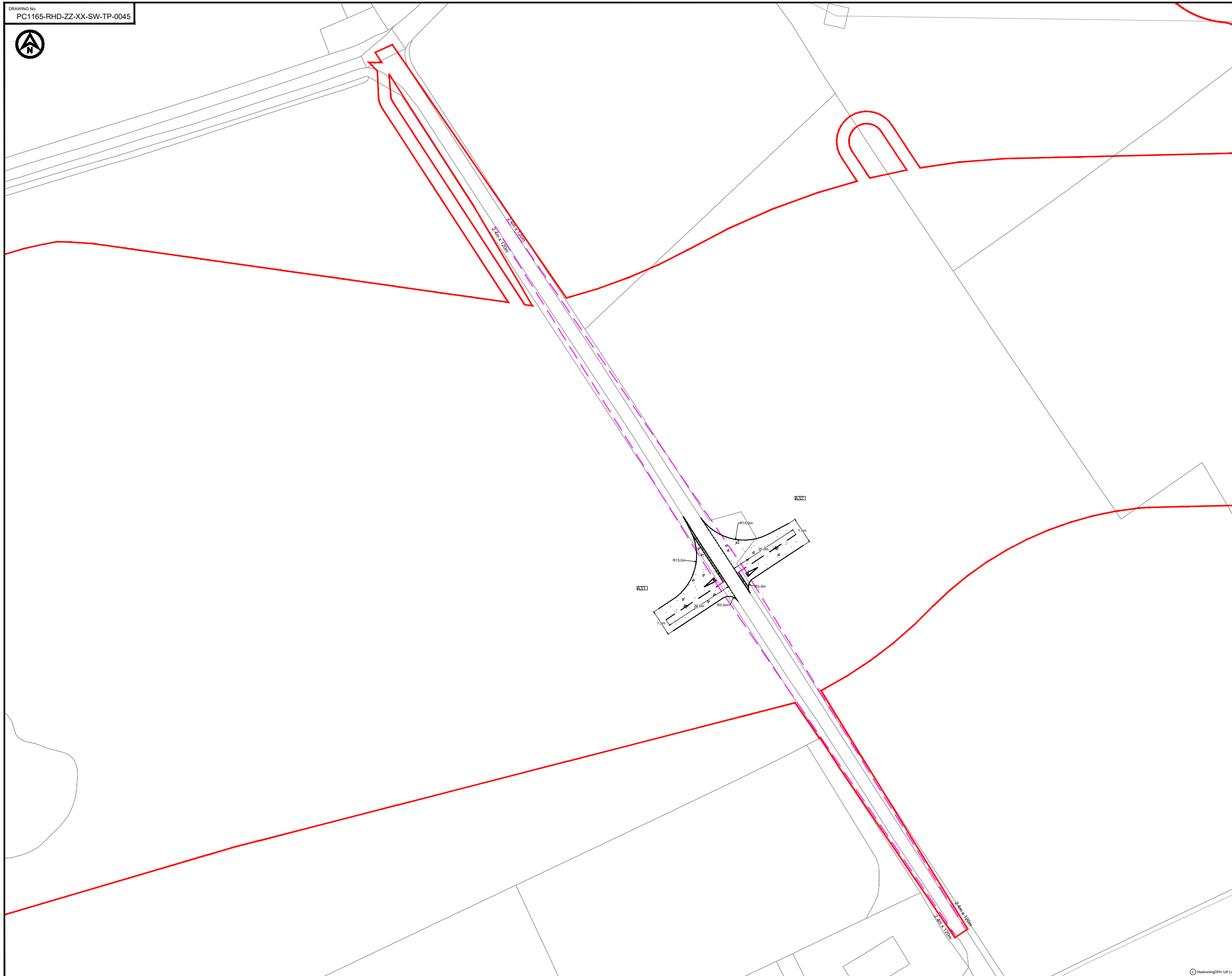

- NOTES**
1. Do not scale from this drawing, all dimensions are in metres unless noted otherwise.
  2. This drawing has been based upon Ordnance Survey Maps and Royal HaskoningDHV can not guarantee the accuracy of data.
  3. X-distance - the set back from the nearest edge of the carriageway from which the access will be taken
  4. Y-Distance - the SSD measured along the nearest edge of the carriageway to its intersection with the centreline of the access.
  5. All vegetation to be cleared/trimmed within identified visibility envelope and thereafter maintained in accordance with Local Highway Authority maintenance practices.

**KEY**

- EXISTING ARRANGEMENT
- PROPOSED ACCESS BOUNDARY/ROAD MARKINGS
- VISIBILITY SPYLA FOR ASSUMED JUNCTION LOCATION
- MORGAN AND MORECAMBE ORDER LIMITS
- FULL DEPTH CARRIAGEWAY CONSTRUCTION WITH BOUND SURFACE

REV	DATE	DESCRIPTION	BY	CHK	APP
P03	01.05.24	UPDATED WORK AREA AND ORDER LIMITS	AA	SKT	SKT
P02	12.01.24	UPGRADED TO ACCESSES	AA	SKT	SKT
P01	15.05.23	FIRST ISSUE	CB	SKT	SKT

REVISIONS

CLIENT

**MORECAMBE OFFSHORE WIND FARM LTD AND MORGAN OFFSHORE WINDFARM LTD**

PROJECT

**MORGAN AND MORECAMBE OFFSHORE WIND FARMS TRANSMISSION ASSETS**

TITLE

**ACCESS A31 AND A32 GENERAL ARRANGEMENT**



DRAWN	CHECKED	APPROVED
CB	SKT	SKT
DATE	SCALE AT A3	AUTOCAD REF.
15.05.23	1:1000	
DRAWING No.	PC1165-RHD-ZZ-XX-SW-TP-0045	REVISION
CLIENT DWG No.		P03



**NOTES**  
 1. Do not scale from this drawing, all dimensions are in metres unless noted otherwise.  
 2. This drawing has been based upon Ordnance Survey Maps and Royal HaskoningDHV can not guarantee the accuracy of data.

**KEY**

- EXISTING ARRANGEMENT
- PROPOSED ACCESS BOUNDARY/ROAD MARKINGS
- MORGAN AND MORECAMBE ORDER LIMITS

**VEHICLE TRACKING**

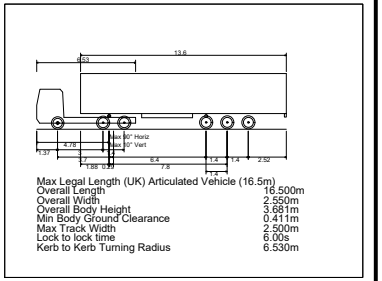

VEHICLE BODY SWEPT PATH (FORWARD GEAR)  
 VEHICLE CHASSIS SWEPT PATH

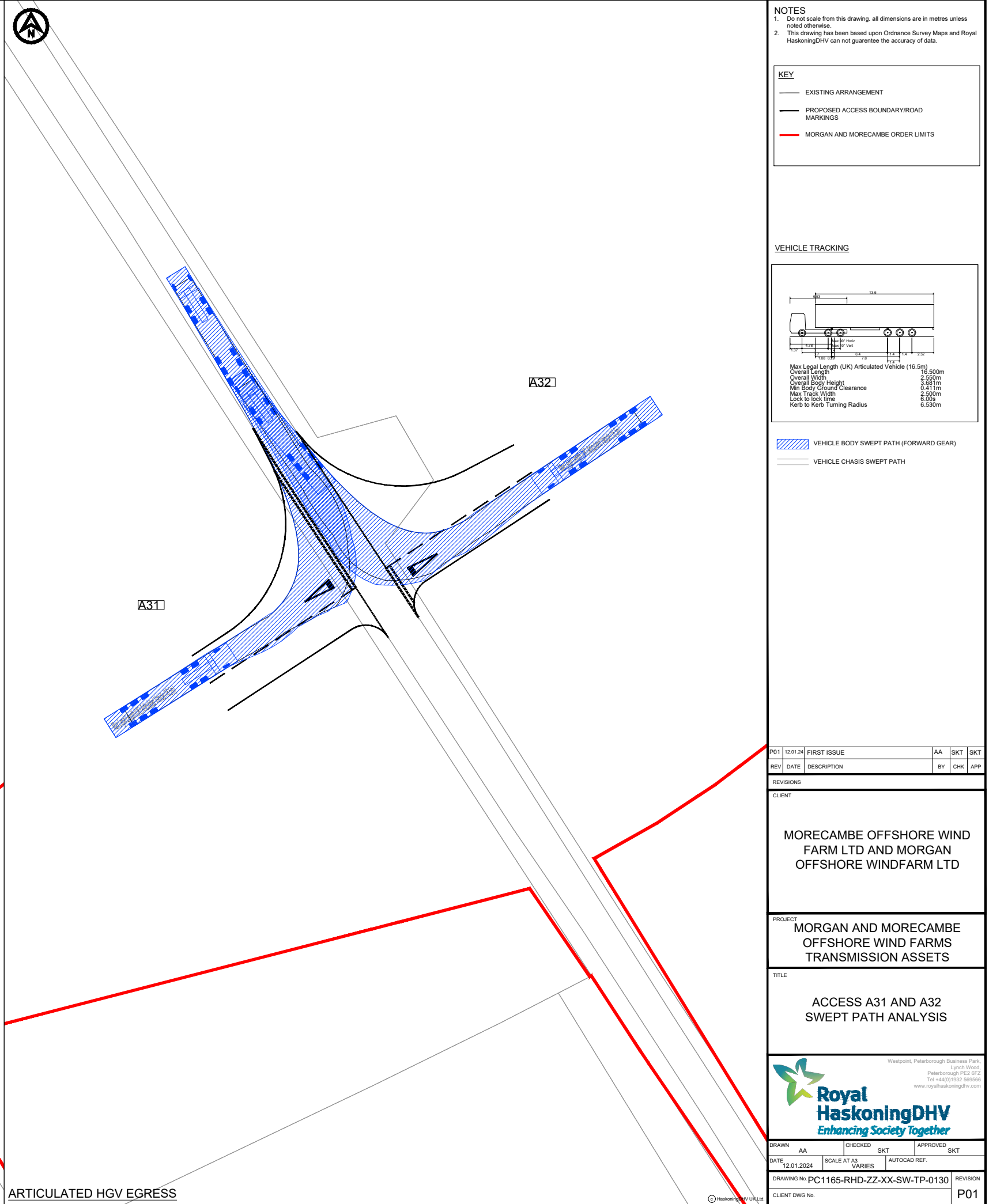
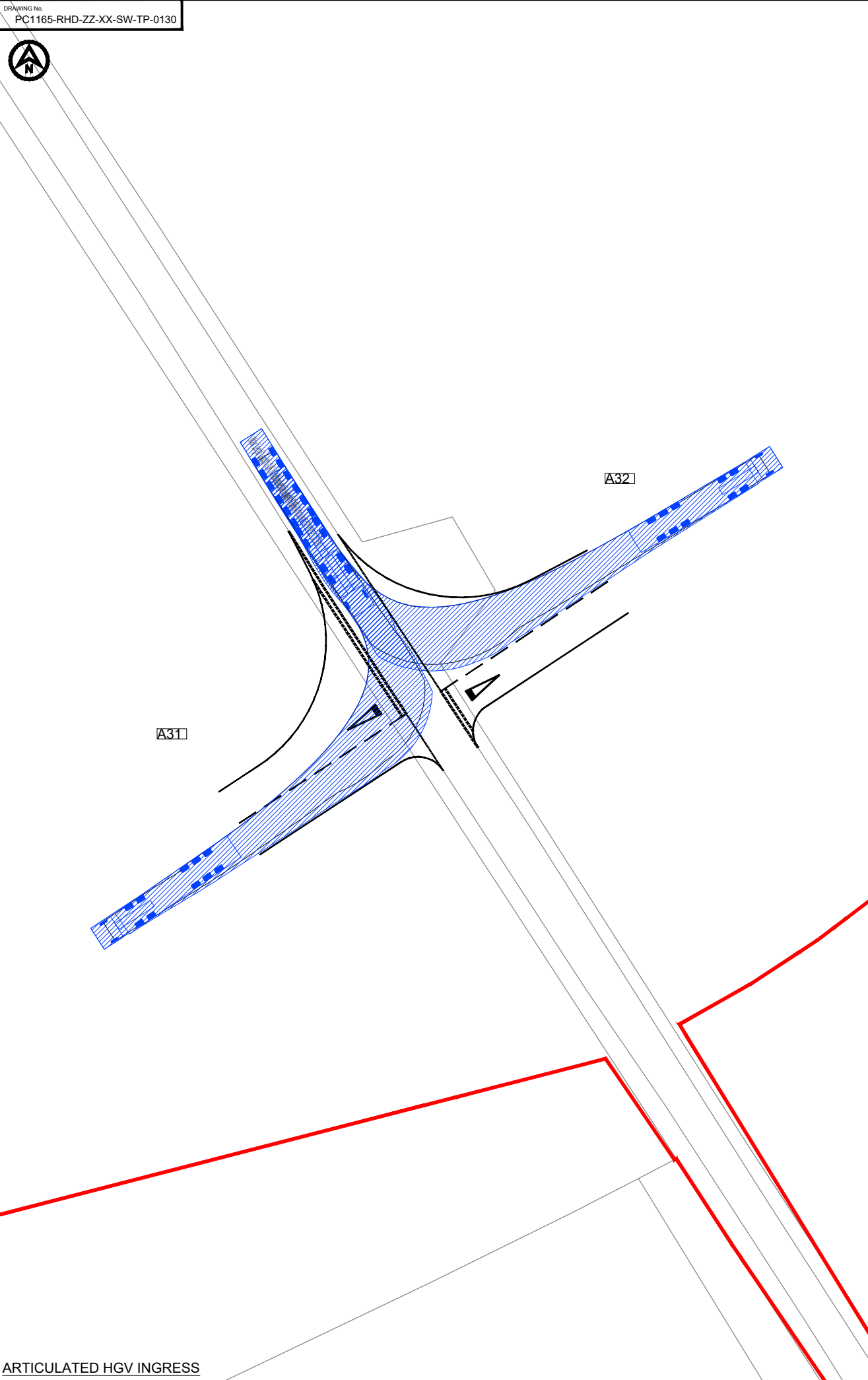

REV	DATE	DESCRIPTION	BY	CHK	APP
P01	12.01.24	FIRST ISSUE	AA	SKT	SKT

REVISIONS

CLIENT

MORECAMBE OFFSHORE WIND FARM LTD AND MORGAN OFFSHORE WINDFARM LTD

PROJECT  
MORGAN AND MORECAMBE OFFSHORE WIND FARMS TRANSMISSION ASSETS

TITLE  
ACCESS A31 AND A32 SWEPT PATH ANALYSIS



DRAWN	CHECKED	APPROVED
AA	SKT	SKT
DATE	SCALE AT A3	AUTOCAD REF.
12.01.2024	VARIES	
DRAWING No.	PC1165-RHD-ZZ-XX-SW-TP-0130	REVISION
CLIENT DWG No.		P01

ARTICULATED HGV INGRESS

ARTICULATED HGV EGRESS

DRAWING No.  
PC1165-RHD-ZZ-XX-SW-TP-0074

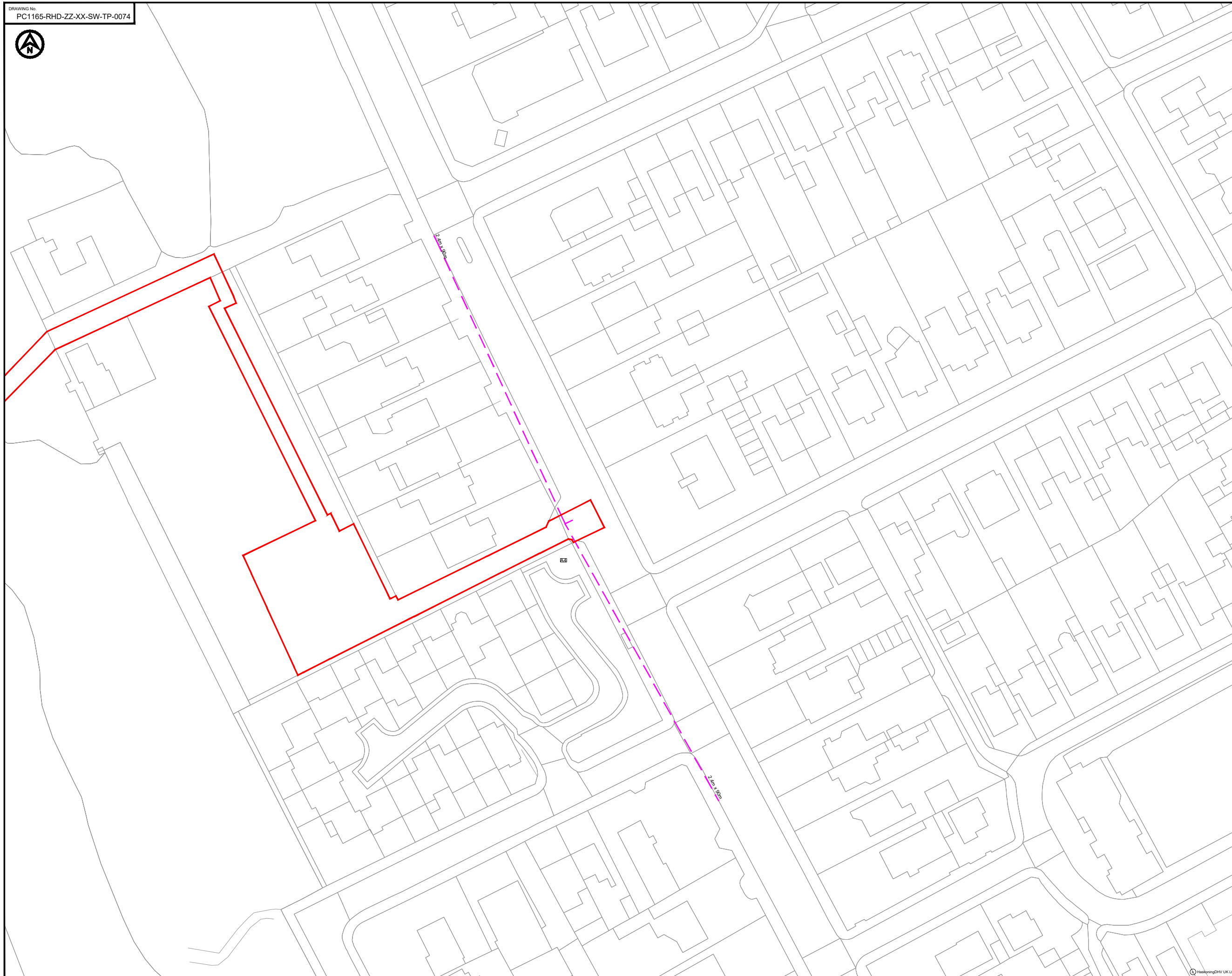

- NOTES**
1. Do not scale from this drawing, all dimensions are in metres unless noted otherwise.
  2. This drawing has been based upon Ordnance Survey Maps and Royal HaskoningDHV can not guarantee the accuracy of data. Carriageway lines are estimated from aerial mapping due to recent highway scheme not being recorded on OS mapping.
  3. X-distance - the set back from the nearest edge of the carriageway from which the access will be taken.
  4. Y-Distance - the SSD measured along the nearest edge of the carriageway to its intersection with the centreline of the access.
  5. All vegetation to be cleared/trimmed within identified visibility envelope and thereafter maintained in accordance with Local Highway Authority maintenance practices.

**KEY**

	EXISTING ARRANGEMENT
	VISIBILITY SPLAY FOR ASSUMED JUNCTION LOCATION
	MORGAN AND MORECAMBE ORDER LIMITS

REV	DATE	DESCRIPTION	BY	CHK	APP
P02	21.05.24	ADDITION OF COMPOUND	CB	SKT	SKT
P01	16.05.23	FIRST ISSUE	AA	SKT	SKT

**REVISIONS**

**CLIENT**

**MORECAMBE OFFSHORE WIND FARM LTD AND MORGAN OFFSHORE WINDFARM LTD**

**PROJECT**

**MORGAN AND MORECAMBE OFFSHORE WIND FARMS TRANSMISSION ASSETS**



DRAWN	CHECKED	APPROVED
AA	SKT	SKT
DATE	SCALE AT A3	AUTOCAD REF.
16.05.23	1:1000	
DRAWING No.	PC1165-RHD-ZZ-XX-SW-TP-0074	REVISION
CLIENT DWG No.		P02



**NOTES**  
 1. Do not scale from this drawing, all dimensions are in metres unless noted otherwise.  
 2. This drawing has been based upon Ordnance Survey Maps and Royal HaskoningDHV can not guarantee the accuracy of data.

**KEY**

	EXISTING ARRANGEMENT
	MORGAN AND MORECAMBE

**VEHICLE TRACKING**

Max Legal Length (UK) Articulated Vehicle (16.5m)  
 Overall Length 15.500m  
 Overall Width 2.550m  
 Overall Body Height 3.581m  
 Min Body Ground Clearance 0.411m  
 Max Track Width 2.500m  
 Lock to lock time 6.00s  
 Kerb to Kerb Turning Radius 6.530m

	VEHICLE BODY SWEEP PATH (FORWARD GEAR)
	VEHICLE CHASSIS SWEEP PATH

REV	DATE	DESCRIPTION	BY	CHK	APP
P02	21.05.24	ADDITION OF COMPOUND	CB	SKT	SKT
P01	15.05.23	FIRST ISSUE	CB	SKT	SKT

REVISIONS

CLIENT

**MORECAMBE OFFSHORE WIND FARM LTD AND MORGAN OFFSHORE WINDFARM LTD**

PROJECT

**MORGAN AND MORECAMBE OFFSHORE WIND FARMS TRANSMISSION ASSETS**

TITLE

**ACCESS A4 SWEEP PATH ANALYSIS**



DRAWN	CB	CHECKED	SKT	APPROVED	SKT
DATE	15.05.2023	SCALE AT A3	1:500	AUTOCAD REF.	
DRAWING No.	PC1165-RHD-ZZ-XX-SW-TP-0068				REVISION
CLIENT DWG No.					P02

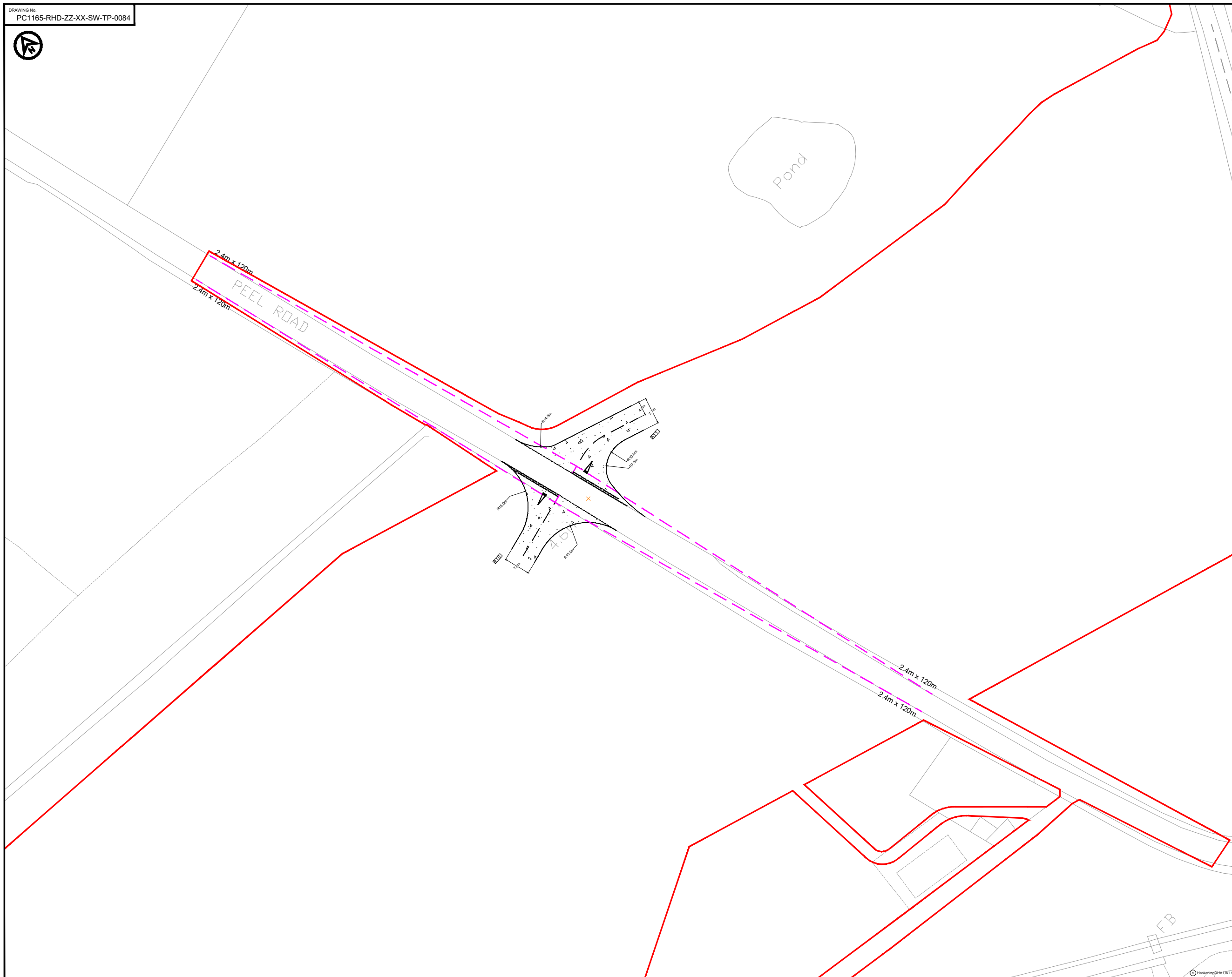

- NOTES**
1. Do not scale from this drawing, all dimensions are in metres unless noted otherwise.
  2. This drawing has been based upon Ordnance Survey Maps and Royal HaskoningDHV can not guarantee the accuracy of data.
  3. X-distance - the set back from the nearest edge of the carriageway from which the access will be taken
  4. Y-Distance - the SSD measured along the nearest edge of the carriageway to its intersection with the centreline of the access.
  5. All vegetation to be cleared/trimmed within identified visibility envelope and thereafter maintained in accordance with Local Highway Authority maintenance practices.

**KEY**

	EXISTING ARRANGEMENT
	PROPOSED ACCESS BOUNDARY/ROAD MARKINGS
	VISIBILITY SPLAY FOR ASSUMED JUNCTION LOCATION
	MORGAN AND MORECAMBE ORDER LIMITS
	FULL DEPTH CARRIAGEWAY CONSTRUCTION WITH BOUND SURFACE

REV	DATE	DESCRIPTION	BY	CHK	APP
P02	30.04.24	UPDATED WORK AREA AND ORDER LIMITS	AA	SKT	SKT
P01	31.05.23	FIRST ISSUE	AA	SKT	SKT

REVISIONS

CLIENT

**MORECAMBE OFFSHORE WIND FARM LTD AND MORGAN OFFSHORE WINDFARM LTD**

**MORGAN AND MORECAMBE OFFSHORE WIND FARMS TRANSMISSION ASSETS**

**ACCESS A10 AND A11 GENERAL ARRANGEMENT**



DRAWN	CHECKED	APPROVED
AA	SKT	SKT
DATE	SCALE AT A3	AUTOCAD REF.
31.05.23	1:1000	
DRAWING No.	PC1165-RHD-ZZ-XX-SW-TP-0084	REVISION
CLIENT DWG No.		P01

DRAWING No.  
PC1165-RHD-ZZ-XX-SW-TP-0085

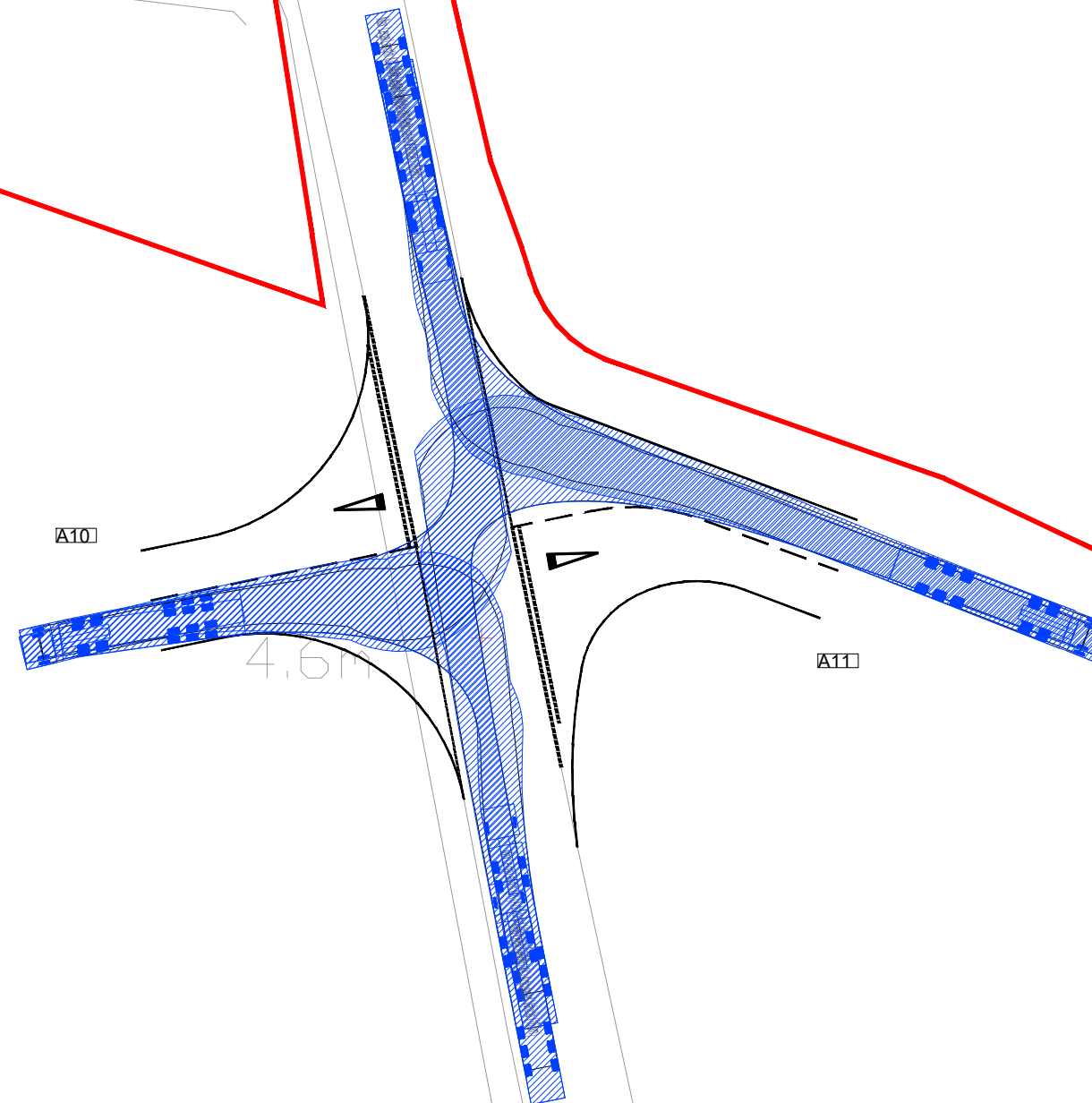

ARTICULATED HGV INGRESS

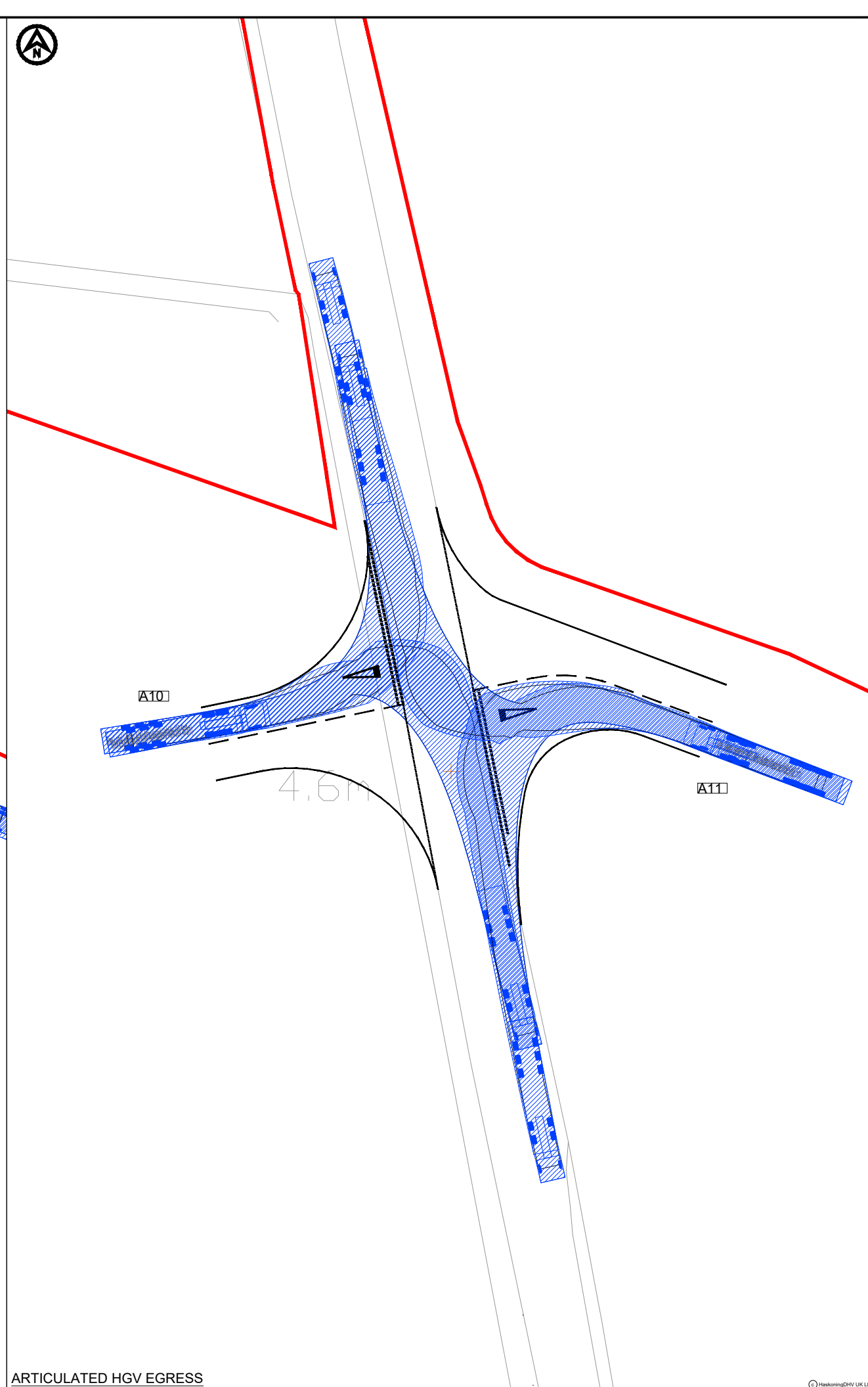

ARTICULATED HGV EGRESS

**NOTES**  
1. Do not scale from this drawing, all dimensions are in metres unless noted otherwise.  
2. This drawing has been based upon Ordnance Survey Maps and Royal HaskoningDHV can not guarantee the accuracy of data.

**KEY**

- EXISTING ARRANGEMENT
- PROPOSED ACCESS BOUNDARY/ROAD MARKINGS
- MORGAN AND MORECAMBE ORDER LIMITS

**VEHICLE TRACKING**

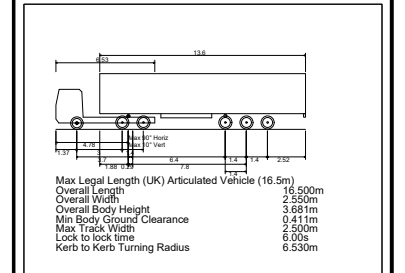

▨ VEHICLE BODY SWEPT PATH (FORWARD GEAR)  
— VEHICLE CHASSIS SWEPT PATH

REV	DATE	DESCRIPTION	BY	CHK	APP
P01	31.05.23	FIRST ISSUE	AA	SKT	SKT

**REVISIONS**

**CLIENT**

MORECAMBE OFFSHORE WIND FARM LTD AND MORGAN OFFSHORE WINDFARM LTD

PROJECT  
MORGAN AND MORECAMBE OFFSHORE WIND FARMS TRANSMISSION ASSETS

TITLE  
ACCESS A10 AND A11 SWEPT PATH ANALYSIS



DRAWN	AA	CHECKED	SKT	APPROVED	SKT
DATE	31.05.23	SCALE AT A3	1:500	AUTOCAD REF.	
DRAWING No.	PC1165-RHD-ZZ-XX-SW-TP-0085				REVISION
CLIENT DWG No.					P01

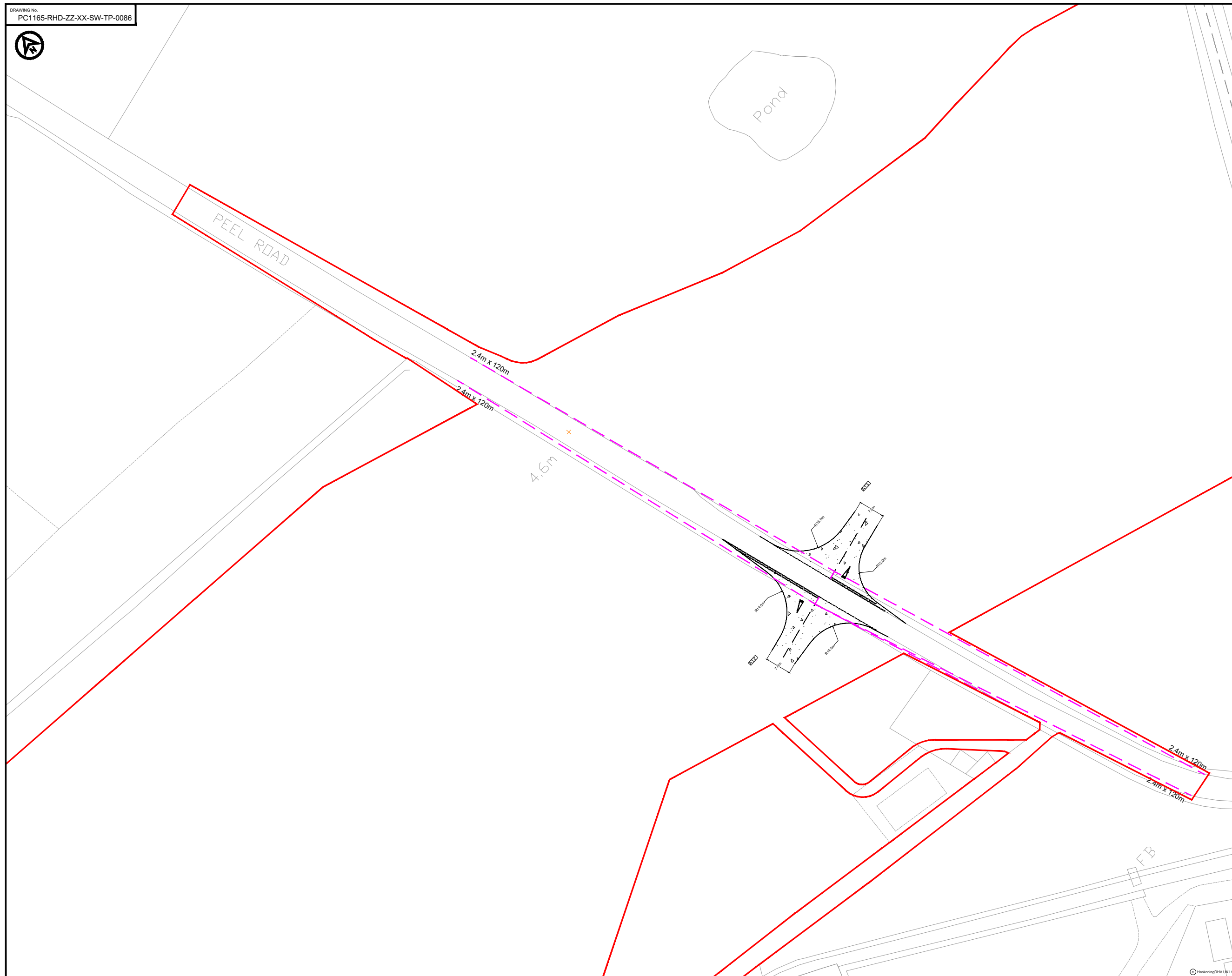

- NOTES**
1. Do not scale from this drawing, all dimensions are in metres unless noted otherwise.
  2. This drawing has been based upon Ordnance Survey Maps and Royal HaskoningDHV can not guarantee the accuracy of data.
  3. X-distance - the set back from the nearest edge of the carriageway from which the access will be taken
  4. Y-Distance - the SSD measured along the nearest edge of the carriageway to its intersection with the centreline of the access.
  5. All vegetation to be cleared/trimmed within identified visibility envelope and thereafter maintained in accordance with Local Highway Authority maintenance practices.

**KEY**

- EXISTING ARRANGEMENT
- PROPOSED ACCESS BOUNDARY/ROAD MARKINGS
- - - VISIBILITY SPLAY FOR ASSUMED JUNCTION LOCATION
- MORGAN AND MORECAMBE ORDER LIMITS
- ▨ FULL DEPTH CARRIAGEWAY CONSTRUCTION WITH BOUND SURFACE

REV	DATE	DESCRIPTION	BY	CHK	APP
P02	30.04.24	UPDATED WORK AREA AND ORDER LIMITS	AA	SKT	SKT
P01	31.05.23	FIRST ISSUE	AA	SKT	SKT

REVISIONS

CLIENT

MORECAMBE OFFSHORE WIND FARM LTD AND MORGAN OFFSHORE WINDFARM LTD

PROJECT  
MORGAN AND MORECAMBE OFFSHORE WIND FARMS TRANSMISSION ASSETS

TITLE  
ACCESS A12 AND A13 GENERAL ARRANGEMENT



DRAWN	AA	CHECKED	SKT	APPROVED	SKT
DATE	31.05.23	SCALE AT A3	1:1000	AUTOCAD REF.	
DRAWING No.	PC1165-RHD-ZZ-XX-SW-TP-0086				REVISION
CLIENT DWG No.					P02



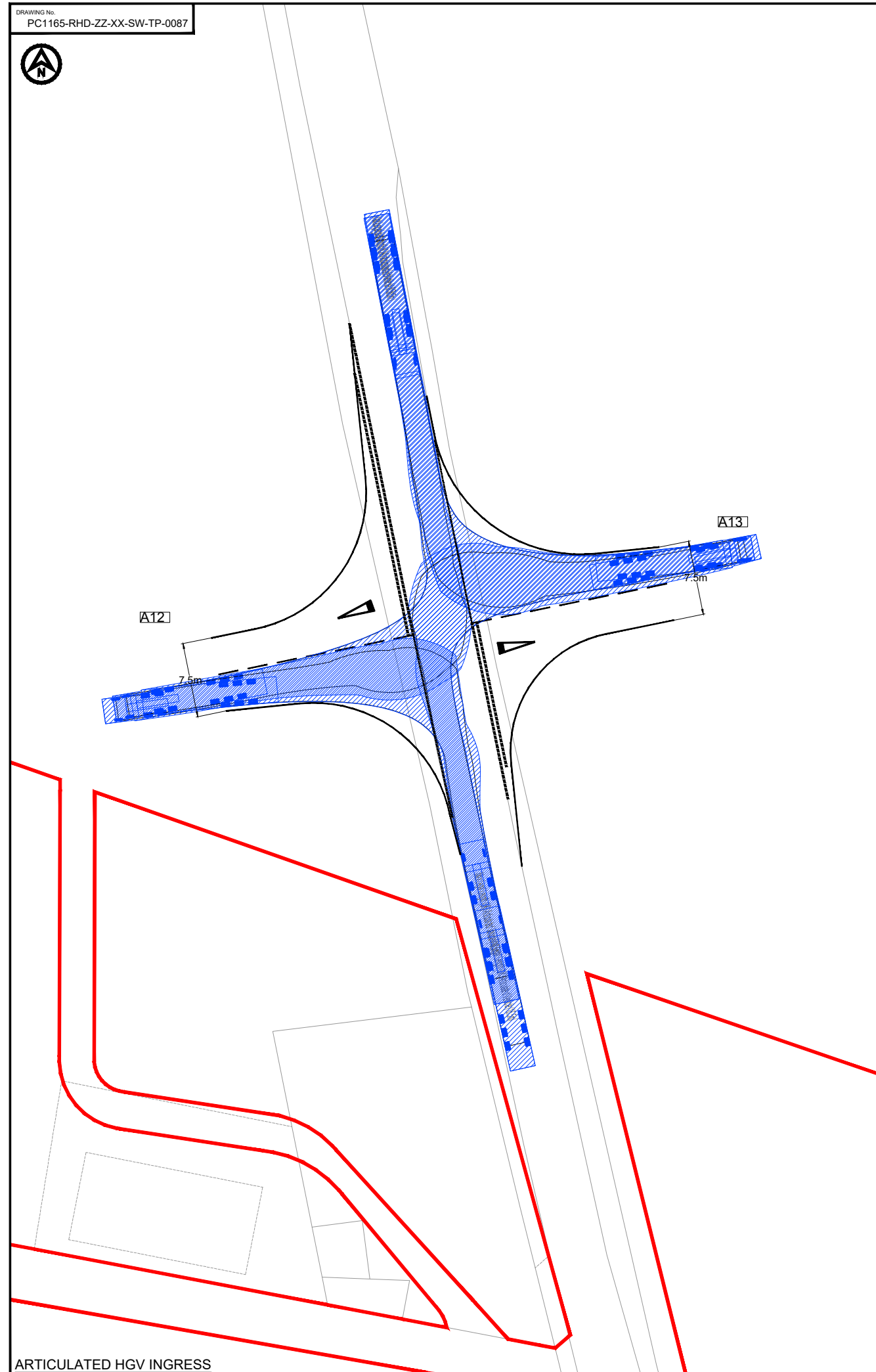

ARTICULATED HGV INGRESS

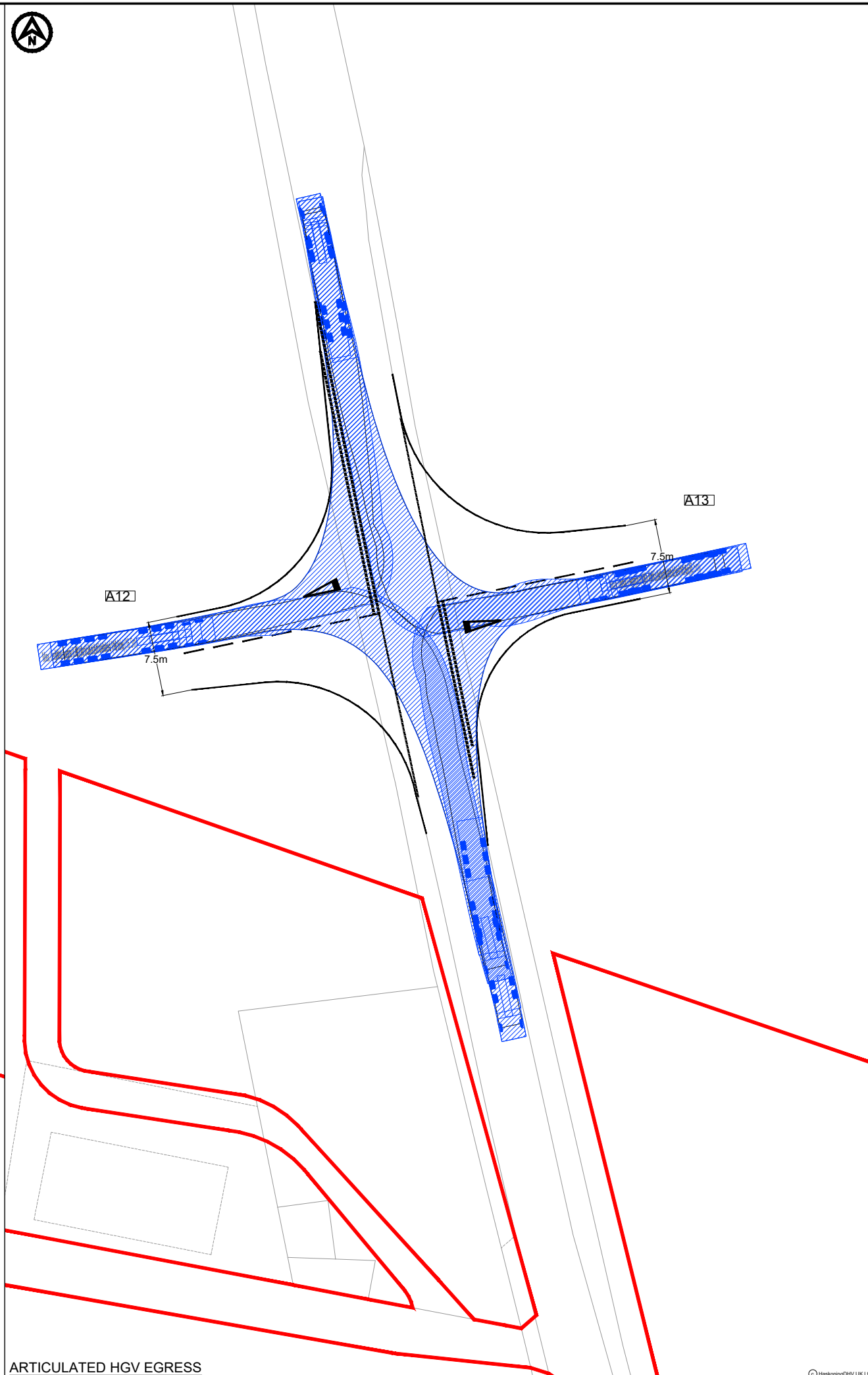

ARTICULATED HGV EGRESS

**NOTES**  
1. Do not scale from this drawing, all dimensions are in metres unless noted otherwise.  
2. This drawing has been based upon Ordnance Survey Maps and Royal HaskoningDHV can not guarantee the accuracy of data.

**KEY**

- EXISTING ARRANGEMENT
- PROPOSED ACCESS BOUNDARY/ROAD MARKINGS
- MORGAN AND MORECAMBE ORDER LIMITS

**VEHICLE TRACKING**

Max Legal Length (UK) Articulated Vehicle (16.5m)  
 Overall Length 2.55m  
 Overall Width 3.68m  
 Min Body Ground Clearance 0.41m  
 Max Track Width 2.50m  
 Lock to lock time 6.00s  
 Kerb to Kerb Turning Radius 6.53m

— VEHICLE BODY SWEEP PATH (FORWARD GEAR)  
 — VEHICLE CHASSIS SWEEP PATH

P01	31.05.23	FIRST ISSUE	AA	SKT	SKT
REV	DATE	DESCRIPTION	BY	CHK	APP

REVISIONS

CLIENT

MORECAMBE OFFSHORE WIND FARM LTD AND MORGAN OFFSHORE WINDFARM LTD

PROJECT  
MORGAN AND MORECAMBE OFFSHORE WIND FARMS TRANSMISSION ASSETS

TITLE  
ACCESS A12 AND A13 SWEEP PATH ANALYSIS



DRAWN	AA	CHECKED	SKT	APPROVED	SKT
DATE	31.05.23	SCALE AT A3	1:500	AUTOCAD REF.	
DRAWING No.	PC1165-RHD-ZZ-XX-SW-TP-0087			REVISION	
CLIENT DWG No.				REVISION	P01

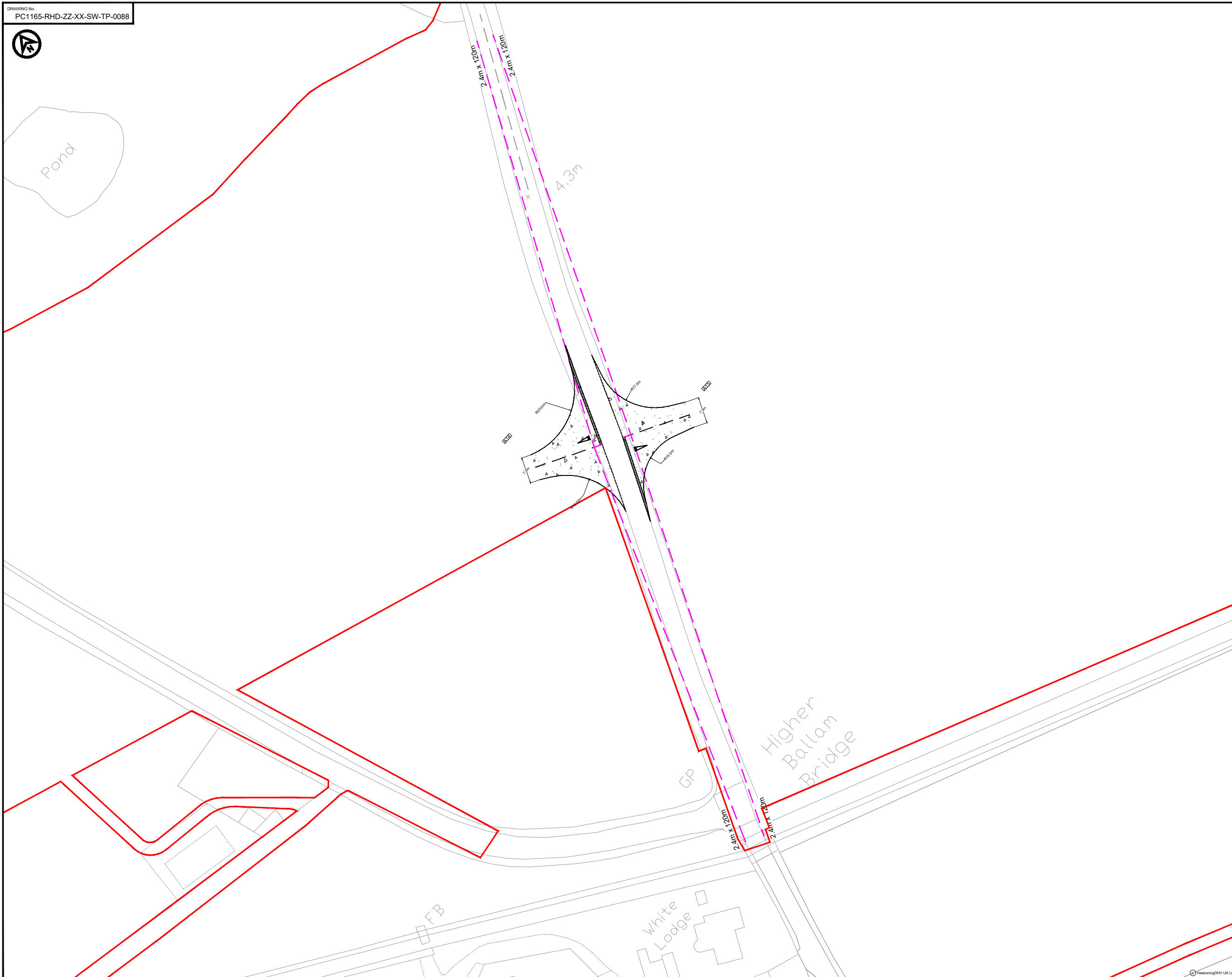

- NOTES**
1. Do not scale from this drawing, all dimensions are in metres unless noted otherwise.
  2. This drawing has been based upon Ordnance Survey Maps and Royal HaskoningDHV can not guarantee the accuracy of data.
  3. X-distance - the set back from the nearest edge of the carriageway from which the access will be taken
  4. Y-Distance - the SSD measured along the nearest edge of the carriageway to its intersection with the centreline of the access.
  5. All vegetation to be cleared/trimmed within identified visibility envelope and thereafter maintained in accordance with Local Highway Authority maintenance practices.

**KEY**

- EXISTING ARRANGEMENT
- PROPOSED ACCESS BOUNDARY/ROAD MARKINGS
- - - VISIBILITY SPLAY FOR ASSUMED JUNCTION LOCATION
- MORGAN AND MORECAMBE ORDER LIMITS
- FULL DEPTH CARRIAGEWAY CONSTRUCTION WITH BOUND SURFACE

REV	DATE	DESCRIPTION	BY	CHK	APP
P02	30.04.24	UPDATED WORK AREA AND ORDER LIMITS	AA	SKT	SKT
P01	31.05.23	FIRST ISSUE	AA	SKT	SKT

REVISIONS

CLIENT

**MORECAMBE OFFSHORE WIND FARM LTD AND MORGAN OFFSHORE WINDFARM LTD**

PROJECT

**MORGAN AND MORECAMBE OFFSHORE WIND FARMS TRANSMISSION ASSETS**

TITLE

**ACCESS A14 AND A15 GENERAL ARRANGEMENT**



DRAWN	CHECKED	APPROVED
AA	SKT	SKT
DATE	SCALE AT A3	AUTOCAD REF.
31.05.23	1:1000	
DRAWING No.	PC1165-RHD-ZZ-XX-SW-TP-0088	REVISION
CLIENT DWG No.		P02



**NOTES**  
 1. Do not scale from this drawing, all dimensions are in metres unless noted otherwise.  
 2. This drawing has been based upon Ordnance Survey Maps and Royal HaskoningDHV can not guarantee the accuracy of data.

**KEY**

	EXISTING ARRANGEMENT
	PROPOSED ACCESS BOUNDARY/ROAD MARKINGS
	MORGAN AND MORECAMBE ORDER LIMITS

**VEHICLE TRACKING**

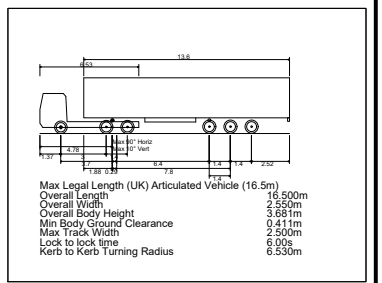

VEHICLE BODY SWEPT PATH (FORWARD GEAR)  
 VEHICLE CHASSIS SWEPT PATH

REV	DATE	DESCRIPTION	BY	CHK	APP
P01	31.05.23	FIRST ISSUE	AA	SKT	SKT

**REVISIONS**

CLIENT

MORECAMBE OFFSHORE WIND FARM LTD AND MORGAN OFFSHORE WINDFARM LTD

PROJECT  
MORGAN AND MORECAMBE OFFSHORE WIND FARMS TRANSMISSION ASSETS

TITLE  
ACCESS A14 AND A15 SWEPT PATH ANALYSIS



DRAWN	AA	CHECKED	SKT	APPROVED	SKT
-------	----	---------	-----	----------	-----

DATE	31.05.23	SCALE AT A3	1:500	AUTOCAD REF.	
------	----------	-------------	-------	--------------	--

DRAWING No.	PC1165-RHD-ZZ-XX-SW-TP-0089	REVISION	
CLIENT DWG No.			P01

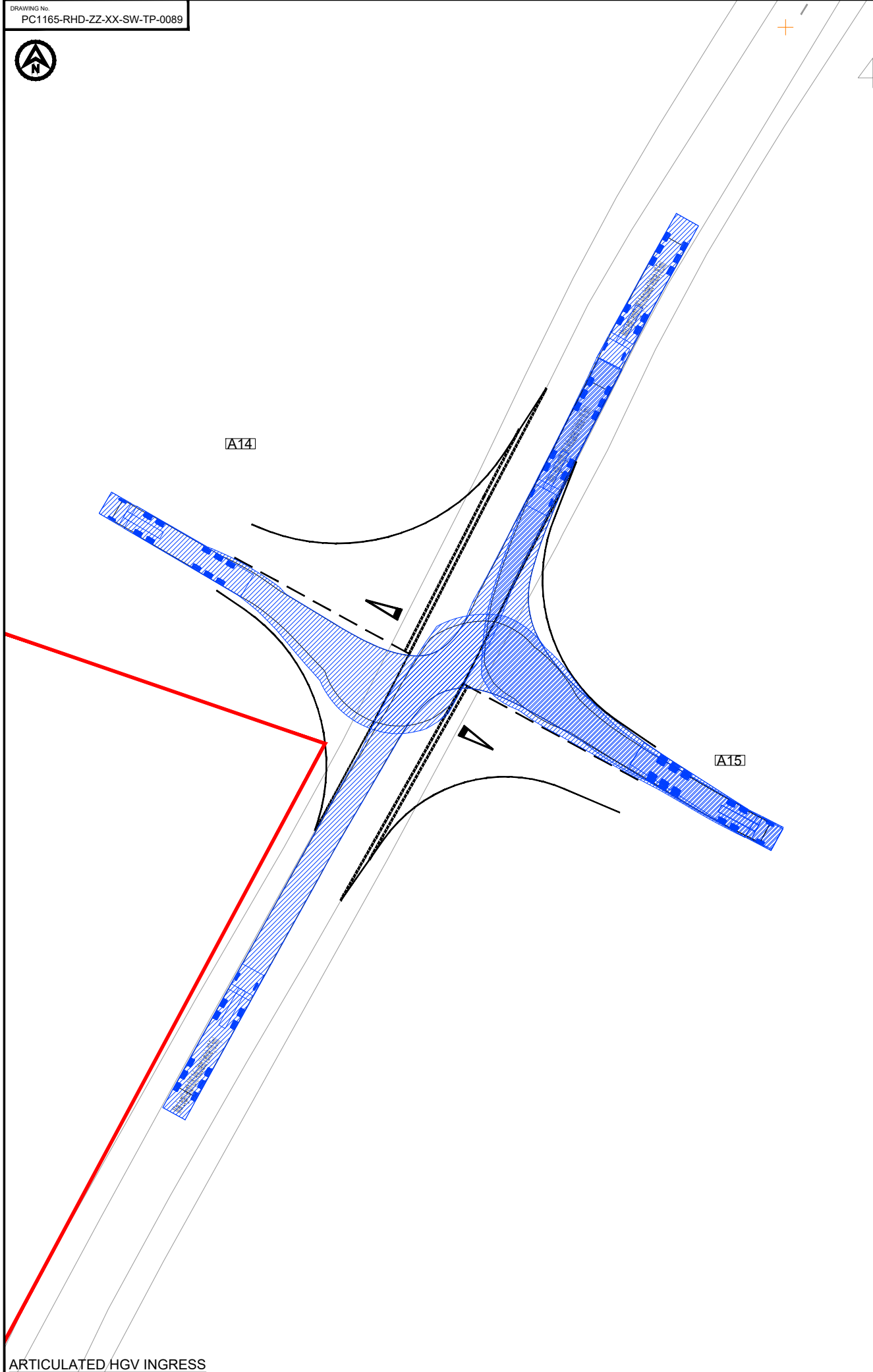

ARTICULATED HGV INGRESS

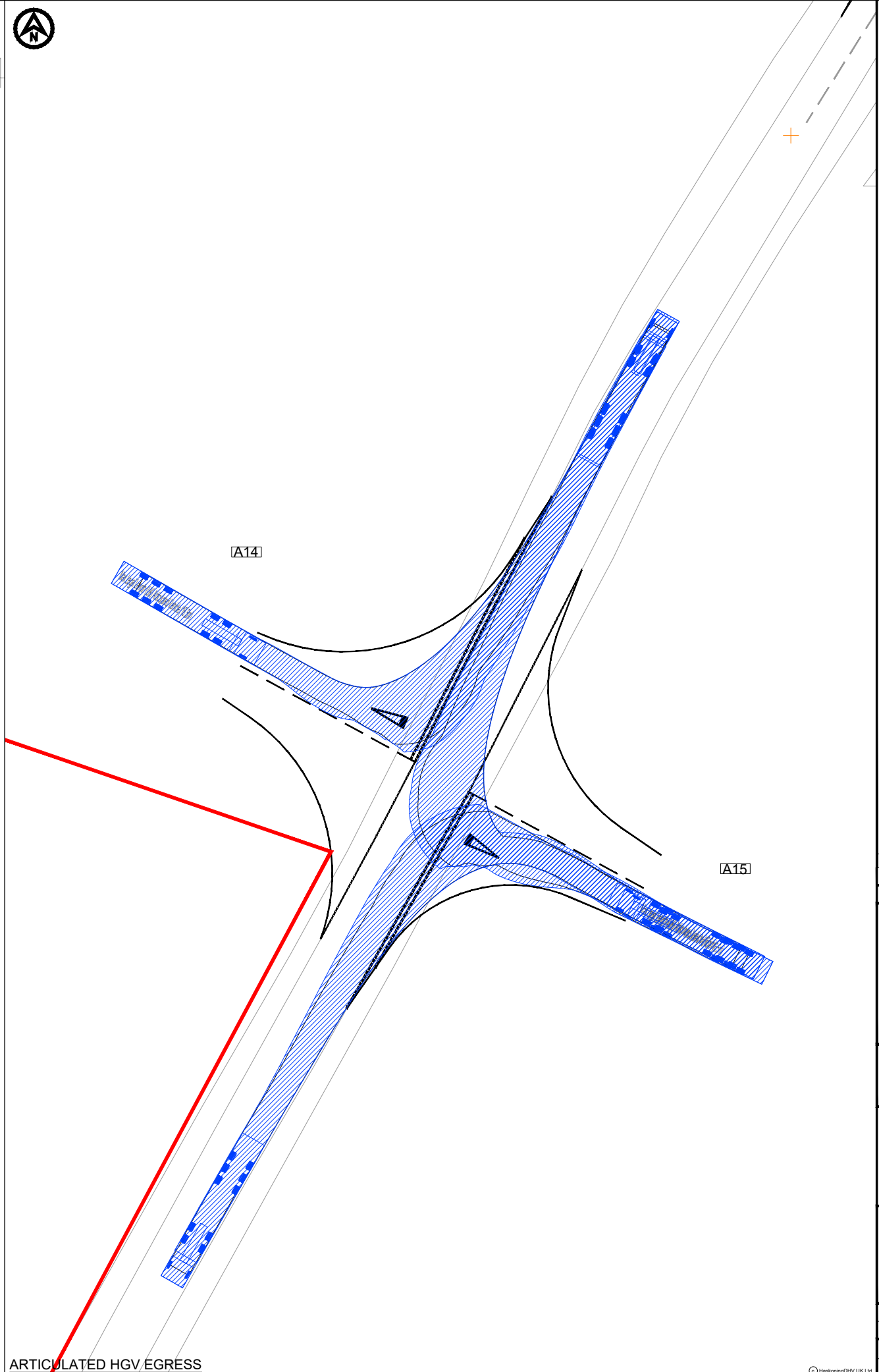

ARTICULATED HGV EGRESS

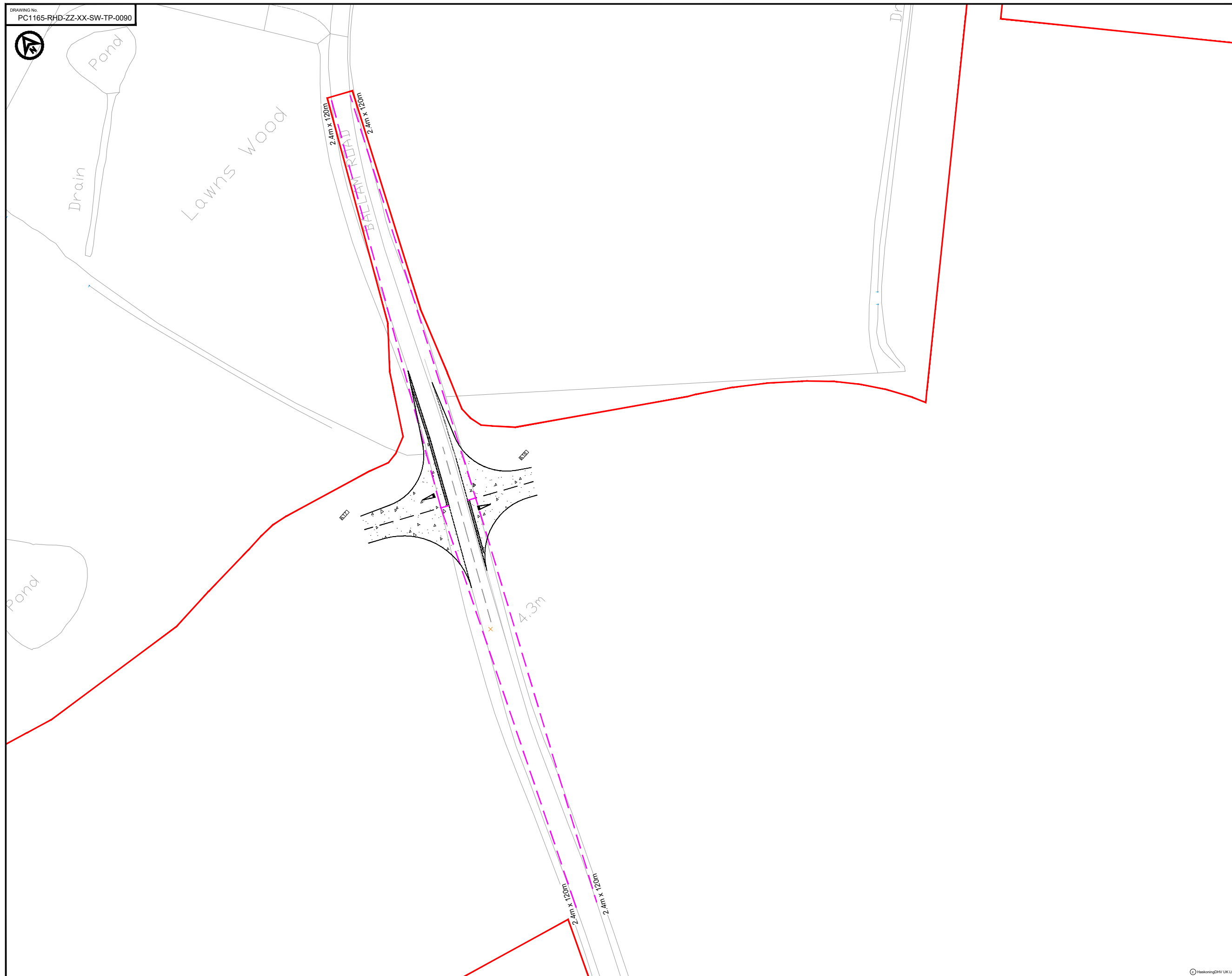

- NOTES**
1. Do not scale from this drawing, all dimensions are in metres unless noted otherwise.
  2. This drawing has been based upon Ordnance Survey Maps and Royal HaskoningDHV can not guarantee the accuracy of data.
  3. X-Distance - the set back from the nearest edge of the carriageway from which the access will be taken
  4. Y-Distance - the SSD measured along the nearest edge of the carriageway to its intersection with the centreline of the access.
  5. All vegetation to be cleared/trimmed within identified visibility envelope and thereafter maintained in accordance with Local Highway Authority maintenance practices.

**KEY**

- EXISTING ARRANGEMENT
- PROPOSED ACCESS BOUNDARY/ROAD MARKINGS
- - - VISIBILITY SPLAY FOR ASSUMED JUNCTION LOCATION
- MORGAN AND MORECAMBE ORDER LIMITS
- FULL DEPTH CARRIAGEWAY CONSTRUCTION WITH BOUND SURFACE

REV	DATE	DESCRIPTION	BY	CHK	APP
P02	30.04.24	UPDATED WORK AREA AND ORDER LIMITS	AA	SKT	SKT
P01	31.05.23	FIRST ISSUE	AA	SKT	SKT

REVISIONS

CLIENT

MORECAMBE OFFSHORE WIND FARM LTD AND MORGAN OFFSHORE WINDFARM LTD

PROJECT  
MORGAN AND MORECAMBE OFFSHORE WIND FARMS TRANSMISSION ASSETS

TITLE  
ACCESS A17 AND A18 GENERAL ARRANGEMENT



DRAWN	CHECKED	APPROVED
AA	SKT	SKT
DATE	SCALE AT A3	AUTOCAD REF.
31.05.23	1:1000	
DRAWING No.	PC1165-RHD-ZZ-XX-SW-TP-0090	REVISION
CLIENT DWG No.		P02



**NOTES**  
 1. Do not scale from this drawing, all dimensions are in metres unless noted otherwise.  
 2. This drawing has been based upon Ordnance Survey Maps and Royal HaskoningDHV can not guarantee the accuracy of data.

**KEY**

- EXISTING ARRANGEMENT
- PROPOSED ACCESS BOUNDARY/ROAD MARKINGS
- MORGAN AND MORECAMBE ORDER LIMITS

**VEHICLE TRACKING**

Max Legal Length (UK) Articulated Vehicle (16.5m)  
 Overall Length 15.500m  
 Overall Width 3.581m  
 Min Body Ground Clearance 0.411m  
 Max Track Width 2.500m  
 Lock to lock time 6.00s  
 Kerb to Kerb Turning Radius 6.530m

- VEHICLE BODY SWEEP PATH (FORWARD GEAR)
- VEHICLE CHASSIS SWEEP PATH

REV	DATE	DESCRIPTION	BY	CHK	APP
P01	31.05.23	FIRST ISSUE	AA	SKT	SKT

**REVISIONS**

**CLIENT**

MORECAMBE OFFSHORE WIND FARM LTD AND MORGAN OFFSHORE WINDFARM LTD

**PROJECT**  
MORGAN AND MORECAMBE OFFSHORE WIND FARMS TRANSMISSION ASSETS

**TITLE**  
ACCESS A17 AND A18 SWEEP PATH ANALYSIS



DRAWN	AA	CHECKED	SKT	APPROVED	SKT
DATE	31.05.23	SCALE AT A3	1:500	AUTOCAD REF.	
DRAWING No.	PC1165-RHD-ZZ-XX-SW-TP-0091				REVISION
CLIENT DWG No.					P01

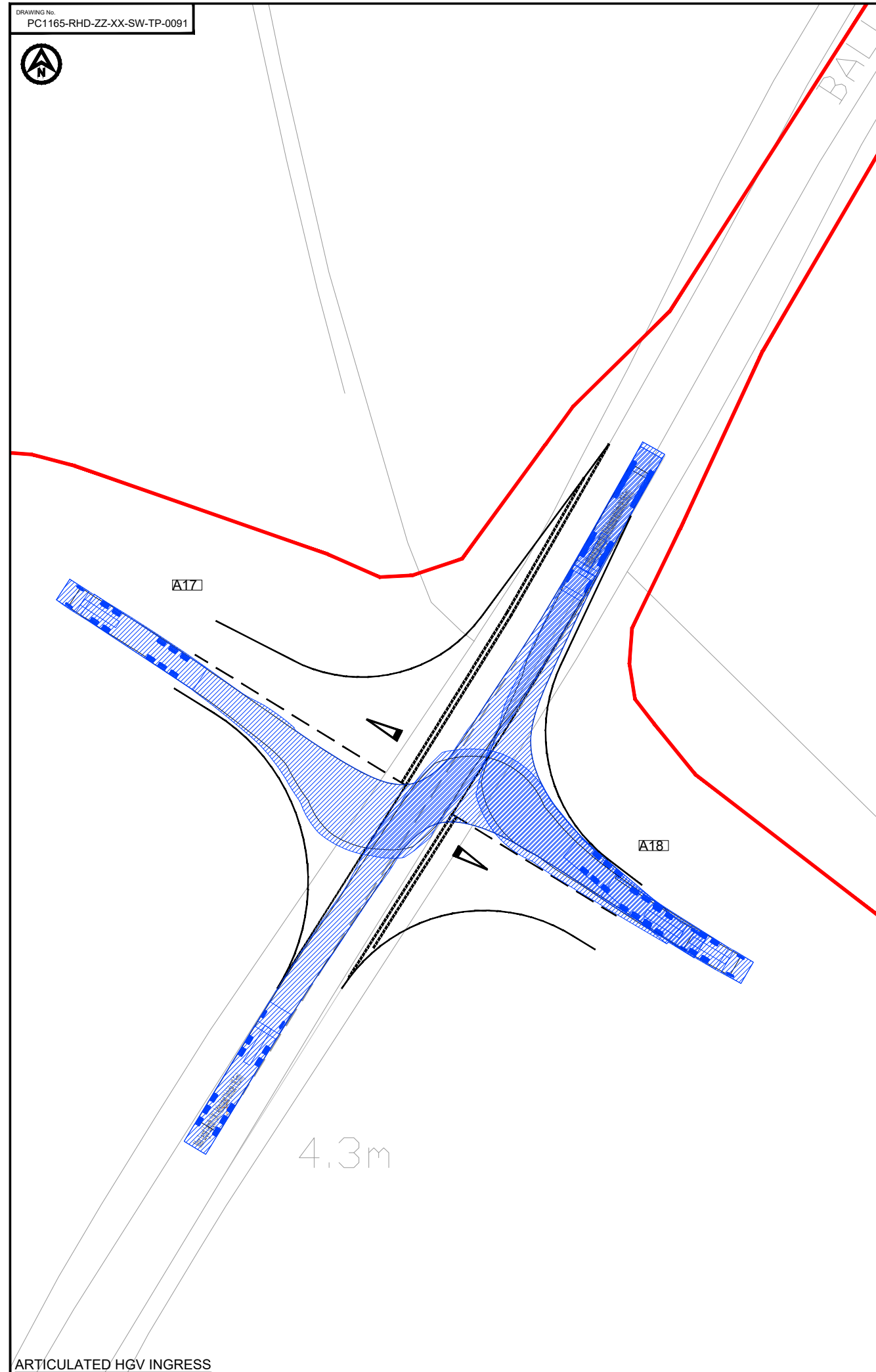

ARTICULATED HGV INGRESS

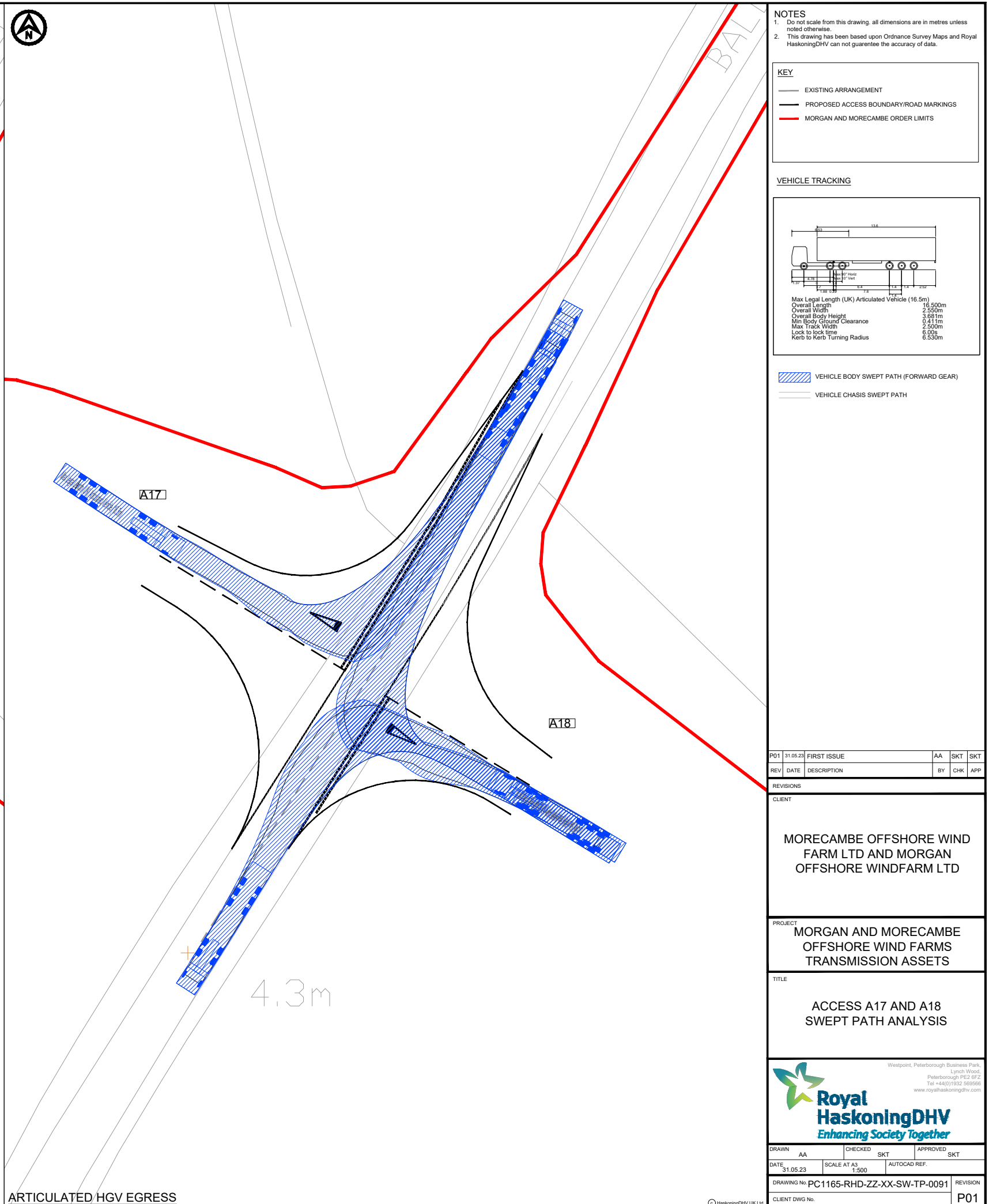

ARTICULATED HGV EGRESS

DRAWING No.  
PC1165-RHD-ZZ-XX-SW-TP-0093



- NOTES**
1. Do not scale from this drawing, all dimensions are in metres unless noted otherwise.
  2. This drawing has been based upon Ordnance Survey Maps and Royal HaskoningDHV can not guarantee the accuracy of data.
  3. X-distance - the set back from the nearest edge of the carriageway from which the access will be taken
  4. Y-Distance - the SSD measured along the nearest edge of the carriageway to its intersection with the centreline of the access.
  5. All vegetation to be cleared/trimmed within identified visibility envelope and thereafter maintained in accordance with Local Highway Authority maintenance practices.

- KEY**
- EXISTING ARRANGEMENT
  - PROPOSED ACCESS BOUNDARY/ROAD MARKINGS
  - - - VISIBILITY SPLAY FOR ASSUMED JUNCTION LOCATION
  - MORGAN AND MORECAMBE ORDER LIMITS
  - FULL DEPTH CARRIAGEWAY CONSTRUCTION WITH BOUND SURFACE

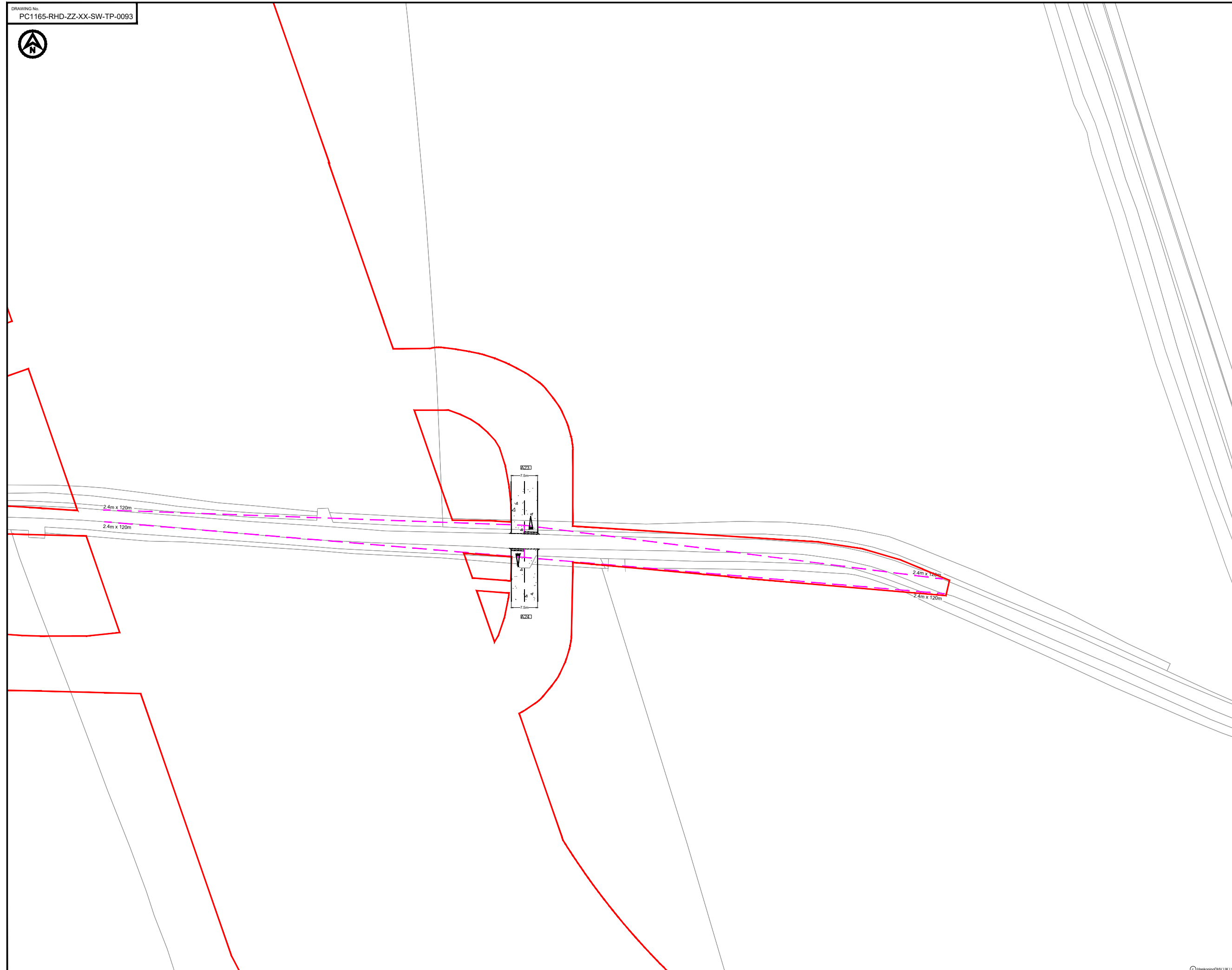

REV	DATE	DESCRIPTION	BY	CHK	APP
P02	01.05.24	UPDATED WORK AREA AND ORDER LIMITS	AA	SKT	SKT
P01	31.05.23	FIRST ISSUE	AA	SKT	SKT

REVISIONS

CLIENT

**MORECAMBE OFFSHORE WIND FARM LTD AND MORGAN OFFSHORE WINDFARM LTD**

**PROJECT**  
MORGAN AND MORECAMBE OFFSHORE WIND FARMS TRANSMISSION ASSETS

**TITLE**  
CROSSING A23 AND A24 GENERAL ARRANGEMENT



DRAWN	AA	CHECKED	SKT	APPROVED	SKT
DATE	31.05.23	SCALE AT A3	1:1000	AUTOCAD REF.	
DRAWING No.	PC1165-RHD-ZZ-XX-SW-TP-0093				REVISION
CLIENT DWG No.					P02



- NOTES**
1. Do not scale from this drawing, all dimensions are in metres unless noted otherwise.
  2. This drawing has been based upon Ordnance Survey Maps and Royal HaskoningDHV can not guarantee the accuracy of data.
  3. X-distance - the set back from the nearest edge of the carriageway from which the access will be taken
  4. Y-Distance - the SSD measured along the nearest edge of the carriageway to its intersection with the centreline of the access.
  5. All vegetation to be cleared/trimmed within identified visibility envelope and thereafter maintained in accordance with Local Highway Authority maintenance practices.

- KEY**
- EXISTING ARRANGEMENT
  - PROPOSED ACCESS BOUNDARY/ROAD MARKINGS
  - - - VISIBILITY SPLAY FOR ASSUMED JUNCTION LOCATION
  - MORGAN AND MORECAMBE ORDER LIMITS
  - FULL DEPTH CARRIAGEWAY CONSTRUCTION WITH BOUND SURFACE



REV	DATE	DESCRIPTION	BY	CHK	APP
P02	01.05.24	UPDATED WORK AREA AND ORDER LIMITS	AA	SKT	SKT
P01	31.05.23	FIRST ISSUE	AA	SKT	SKT

REVISIONS

CLIENT

**MORECAMBE OFFSHORE WIND FARM LTD AND MORGAN OFFSHORE WINDFARM LTD**

**PROJECT**  
MORGAN AND MORECAMBE OFFSHORE WIND FARMS TRANSMISSION ASSETS

**TITLE**  
CROSSING A21 AND A22 GENERAL ARRANGEMENT



DRAWN	CHECKED	APPROVED
AA	SKT	SKT
DATE	SCALE AT A3	AUTOCAD REF.
31.05.23	1:1000	
DRAWING No.	PC1165-RHD-ZZ-XX-SW-TP-0094	REVISION
CLIENT DWG No.		P02



- NOTES**
1. Do not scale from this drawing, all dimensions are in metres unless noted otherwise.
  2. This drawing has been based upon Ordnance Survey Maps and Royal HaskoningDHV can not guarantee the accuracy of data.
  3. X-Distance - the set back from the nearest edge of the carriageway from which the access will be taken
  4. Y-Distance - the SSD measured along the nearest edge of the carriageway to its intersection with the centreline of the access.
  5. All vegetation to be cleared/trimmed within identified visibility envelope and thereafter maintained in accordance with Local Highway Authority maintenance practices.

- KEY**
- EXISTING ARRANGEMENT
  - PROPOSED ACCESS BOUNDARY/ROAD MARKINGS
  - - - VISIBILITY SPLAY FOR ASSUMED JUNCTION LOCATION
  - MORGAN AND MORECAMBE ORDER LIMITS
  - FULL DEPTH CARRIAGEWAY CONSTRUCTION WITH BOUND SURFACE

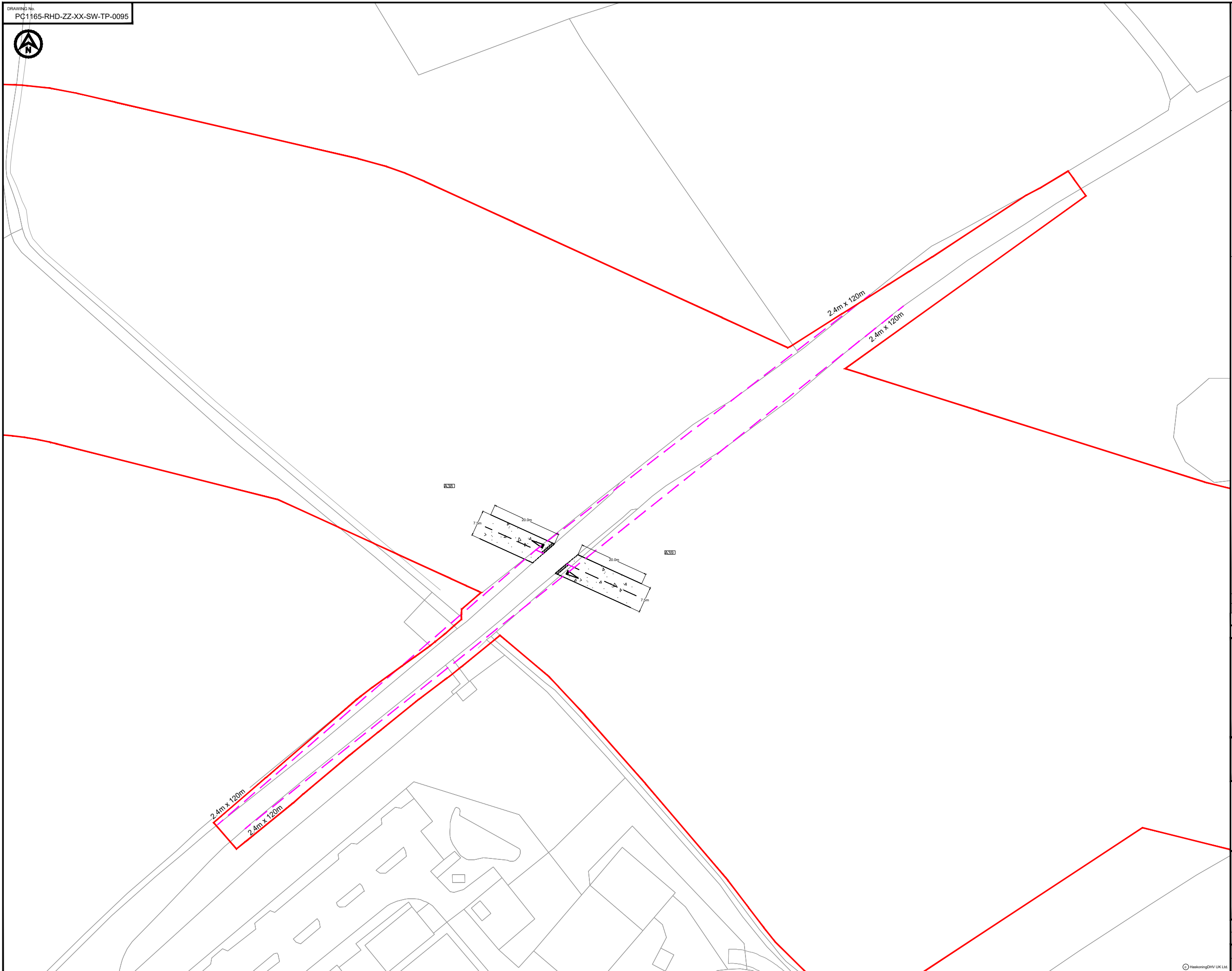

P02	02.05.24	UPDATED WORK AREA AND ORDER LIMITS	AA	SKT	SKT
P01	31.05.23	FIRST ISSUE	AA	SKT	SKT
REV	DATE	DESCRIPTION	BY	CHK	APP

REVISIONS

CLIENT

MORECAMBE OFFSHORE WIND FARM LTD AND MORGAN OFFSHORE WINDFARM LTD

PROJECT  
MORGAN AND MORECAMBE OFFSHORE WIND FARMS TRANSMISSION ASSETS

TITLE  
CROSSING A38 AND A39 GENERAL ARRANGEMENT



DRAWN	AA	CHECKED	SKT	APPROVED	SKT
DATE	31.05.23	SCALE AT A3	1:1000	AUTOCAD REF.	
DRAWING No.	PC1165-RHD-ZZ-XX-SW-TP-0095			REVISION	
CLIENT DWG No.					P02





- NOTES**
1. Do not scale from this drawing, all dimensions are in metres unless noted otherwise.
  2. This drawing has been based upon Ordnance Survey Maps and Royal HaskoningDHV can not guarantee the accuracy of data.
  3. X-distance - the set back from the nearest edge of the carriageway from which the access will be taken
  4. Y-Distance - the SSD measured along the nearest edge of the carriageway to its intersection with the centreline of the access.
  5. All vegetation to be cleared/trimmed within identified visibility envelope and thereafter maintained in accordance with Local Highway Authority maintenance practices.

**KEY**

- EXISTING ARRANGEMENT
- PROPOSED ACCESS BOUNDARY/ROAD MARKINGS
- MORGAN AND MORECAMBE ORDER LIMITS
- VISIBILITY SPLAY FOR ASSUMED JUNCTION LOCATION
- FULL DEPTH CARRIAGEWAY CONSTRUCTION WITH BOUND SURFACE
- ▨ PROPOSED EXTENTS OF JUNCTION WIDENING
- ⊘ PROPOSED GATE

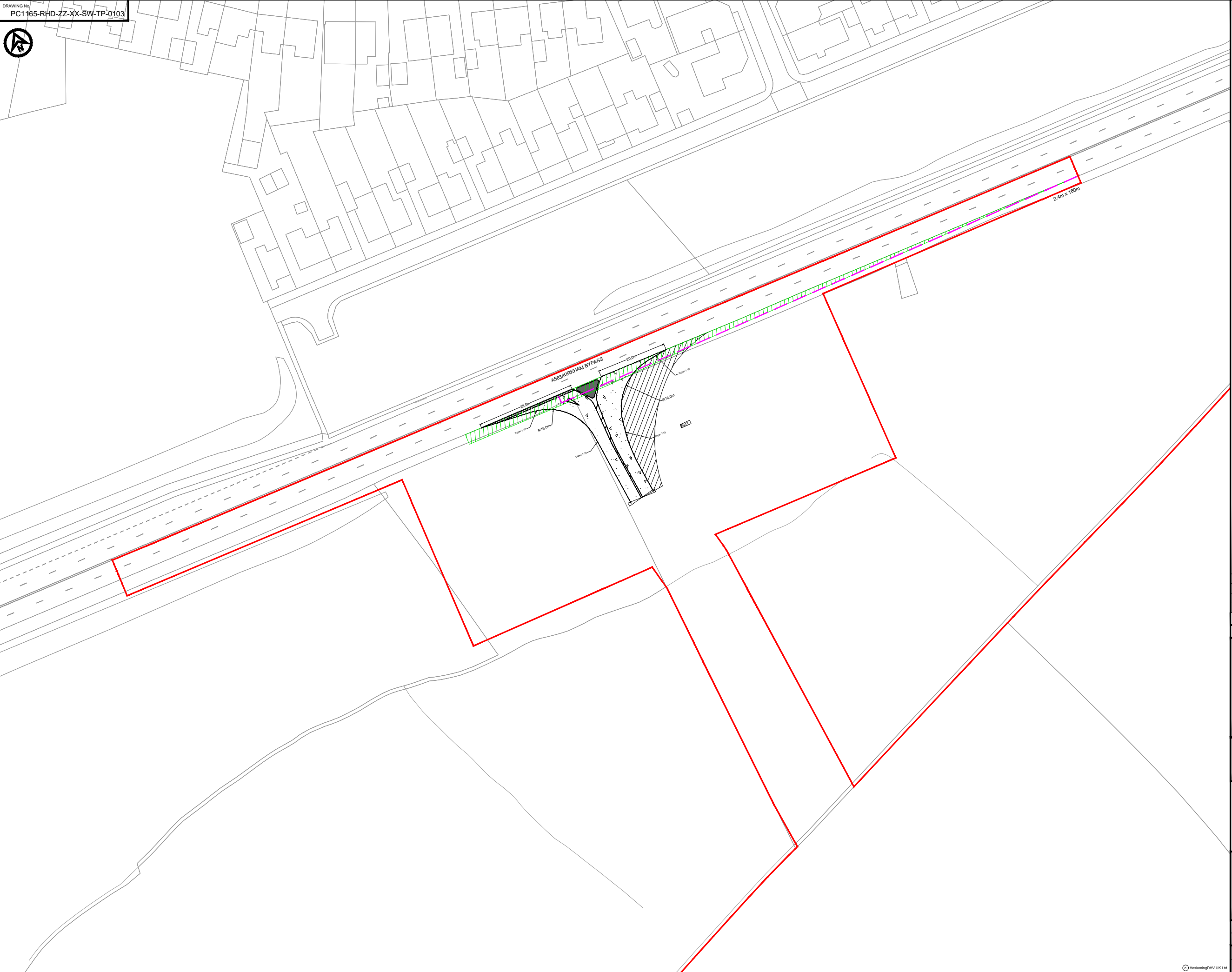

REV	DATE	DESCRIPTION	BY	CHK	APP
P04	02.05.24	UPDATED WORK AREA AND ORDER LIMITS	AA	SKT	SKT
P03	28.03.24	ACCESS MOVED TO THE EAST	AA	SKT	SKT
P02	21.12.23	UPDATED LOCATION OF THE ACCESS	AA	SKT	SKT
P01	05.12.23	FIRST ISSUE	AA	SKT	SKT

REVISIONS

CLIENT

**MORECAMBE OFFSHORE WIND FARM LTD AND MORGAN OFFSHORE WINDFARM LTD**

**PROJECT**  
MORGAN AND MORECAMBE OFFSHORE WIND FARMS TRANSMISSION ASSETS

**TITLE**  
A01 ACCESS GENERAL ARRANGEMENT



DRAWN	AA	CHECKED	SKT	APPROVED	SKT
DATE	05.12.23	SCALE AT A3	1:1000	AUTOCAD REF.	
DRAWING No.	PC1165-RHD-ZZ-XX-SW-TP-0103				REVISION
CLIENT DWG No.					P04



**NOTES**  
 1. Do not scale from this drawing, all dimensions are in metres unless noted otherwise.  
 2. This drawing has been based upon Ordnance Survey Maps and Royal HaskoningDHV can not guarantee the accuracy of data.

**KEY**

- EXISTING ARRANGEMENT
- PROPOSED ACCESS BOUNDARY/ROAD MARKINGS
- MORGAN AND MORECAMBE ORDER LIMITS
- ◊ PROPOSED GATE

**VEHICLE TRACKING**

Max Legal Length (UK) Articulated Vehicle (16.5m)  
 Overall Length 16.500m  
 Overall Width 2.550m  
 Overall Body Height 3.881m  
 Min Body Ground Clearance 0.411m  
 Max Track Width 2.500m  
 Lock to lock time 6.90s  
 Kerb to Kerb Turning Radius 6.530m

▨ VEHICLE BODY SWEEP PATH (FORWARD GEAR)  
 — VEHICLE CHASSIS SWEEP PATH

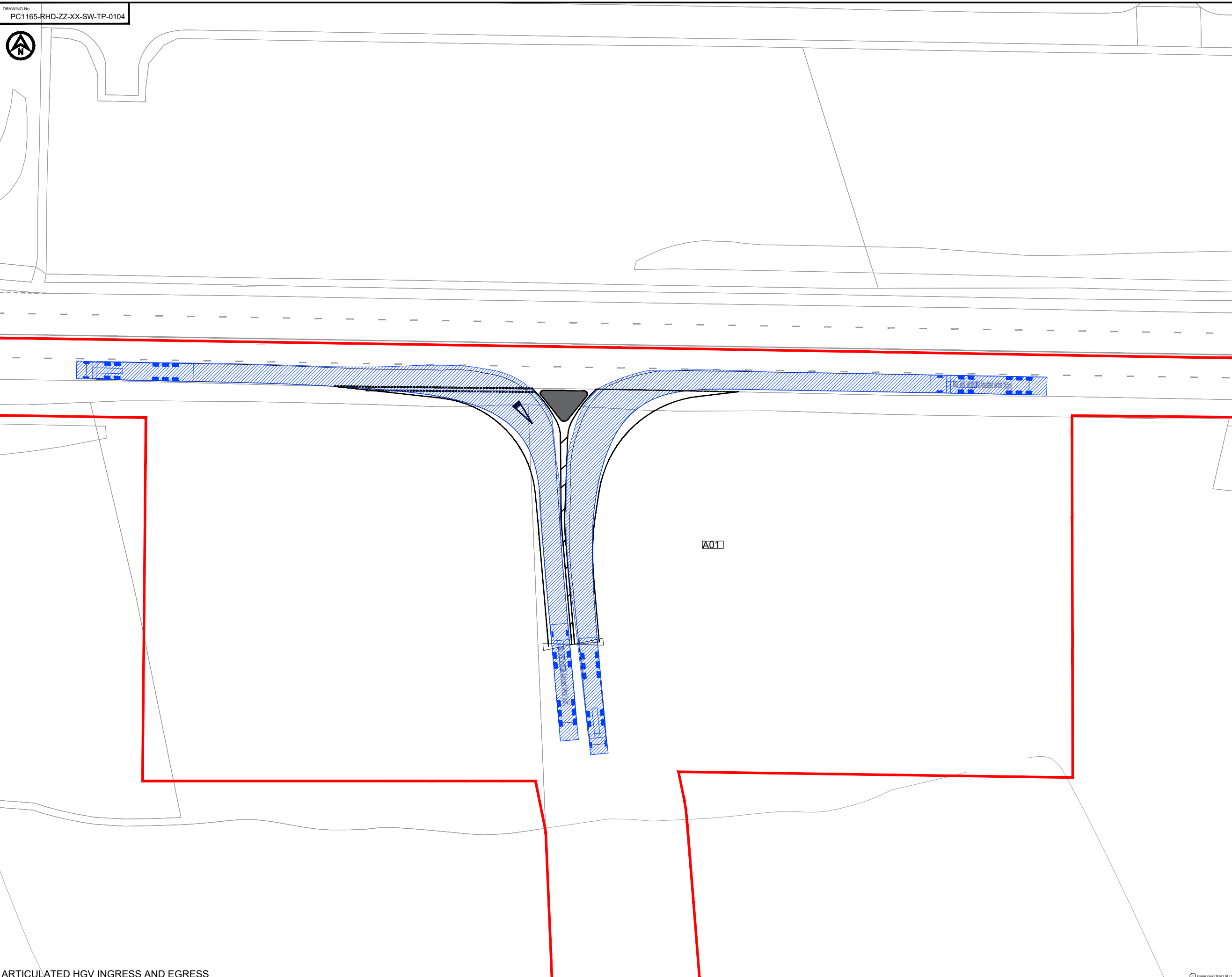

REV	DATE	DESCRIPTION	BY	CHK	APP
P03	28.03.24	ACCESS MOVED TO THE EAST	AA	SKT	SKT
P02	21.12.23	UPDATED LOCATION OF THE ACCESS	AA	SKT	SKT
P01	05.12.23	FIRST ISSUE	AA	SKT	SKT

**REVISIONS**

**CLIENT**

**MORECAMBE OFFSHORE WIND FARM LTD AND MORGAN OFFSHORE WINDFARM LTD**

**PROJECT**

**MORGAN AND MORECAMBE OFFSHORE WIND FARMS TRANSMISSION ASSETS**

**TITLE**

**A01 ACCESS SWEEP PATH ANALYSIS**



DRAWN	CHECKED	APPROVED
AA	SKT	SKT
DATE	SCALE AT A3	AUTOCAD REF.
05.12.23	1:500	
DRAWING No.	PC1165-RHD-ZZ-XX-SW-TP-0104	REVISION
CLIENT DWG No.		P03



**NOTES**  
 1. Do not scale from this drawing, all dimensions are in metres unless noted otherwise.  
 2. This drawing has been based upon Ordnance Survey Maps and Royal HaskoningDHV can not guarantee the accuracy of data.

**KEY**

- EXISTING ARRANGEMENT
- PROPOSED ACCESS BOUNDARY/ROAD MARKINGS
- MORGAN AND MORECAMBE ORDER LIMITS
- ▨ PROPOSED EXTENTS OF JUNCTION WIDENING
- ◊ PROPOSED GATE

**VEHICLE TRACKING**

Abnormal Load Carrier	80.103m
Overall Length	3.020m
Overall Body Height	3.725m
Min Body Ground Clearance	0.075m
Max Track Width	3.700m
Lock to Lock Time	0.02s
Wall to Wall Turning Radius	31.150m

▨ VEHICLE BODY SWEPT PATH (FORWARD GEAR)  
 — VEHICLE CHASSIS SWEPT PATH

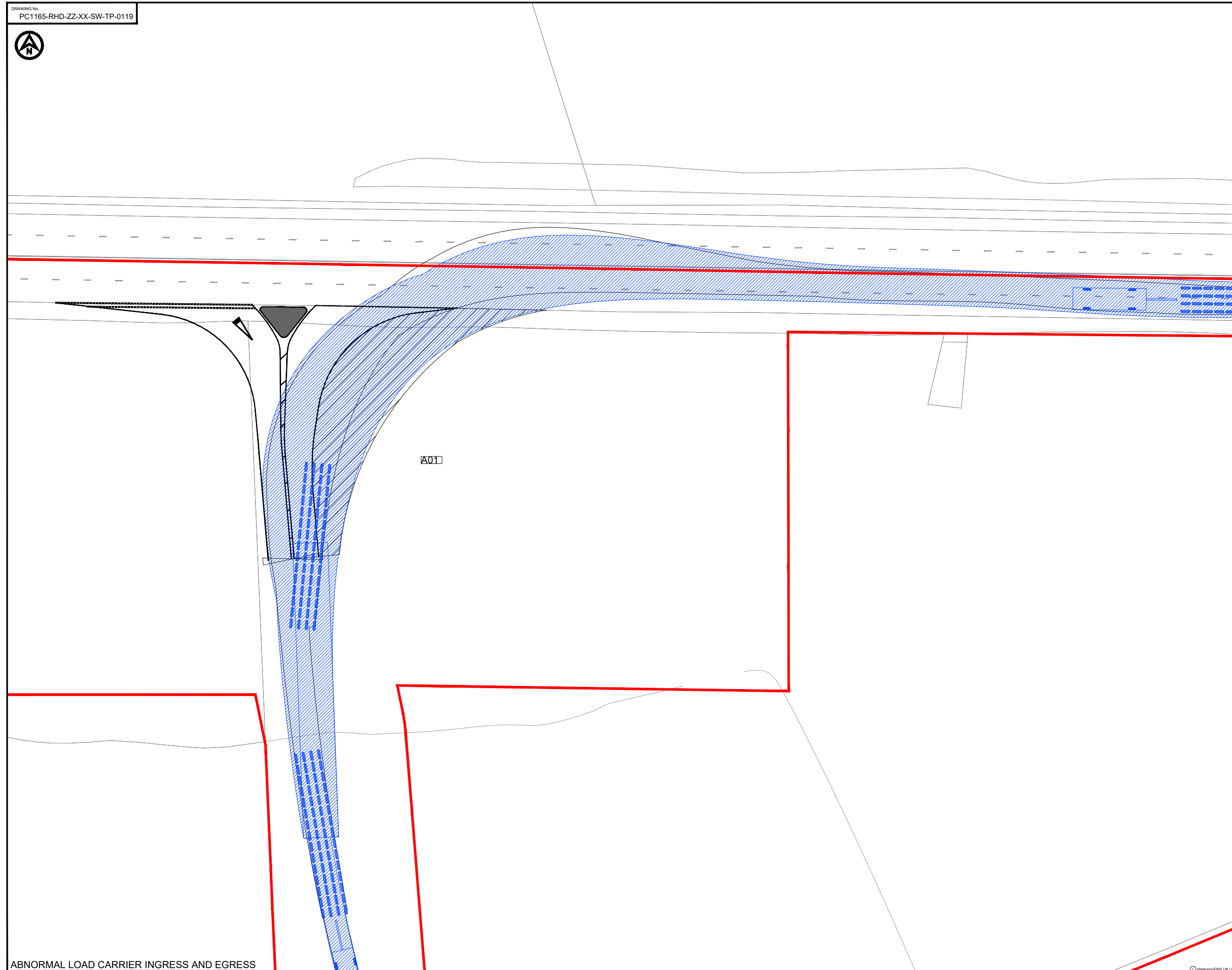

P03	28.03.24	ACCESS MOVED TO THE EAST	AA	SKT	SKT
P02	21.12.23	UPDATED LOCATION OF THE ACCESS	AA	SKT	SKT
P01	11.12.23	FIRST ISSUE	AA	SKT	SKT

REVISIONS

CLIENT

**MORECAMBE OFFSHORE WIND FARM LTD AND MORGAN OFFSHORE WINDFARM LTD**

**MORGAN AND MORECAMBE OFFSHORE WIND FARMS TRANSMISSION ASSETS**

**A01 ACCESS SWEPT PATH ANALYSIS - ABNORMAL LOAD CARRIER**



DRAWN	AA	CHECKED	SKT	APPROVED	SKT
DATE	11.12.23	SCALE AT A3	1:500	AUTOCAD REF.	
DRAWING No.	PC1165-RHD-ZZ-XX-SW-TP-0119				REVISION
CLIENT DWG No.					P03

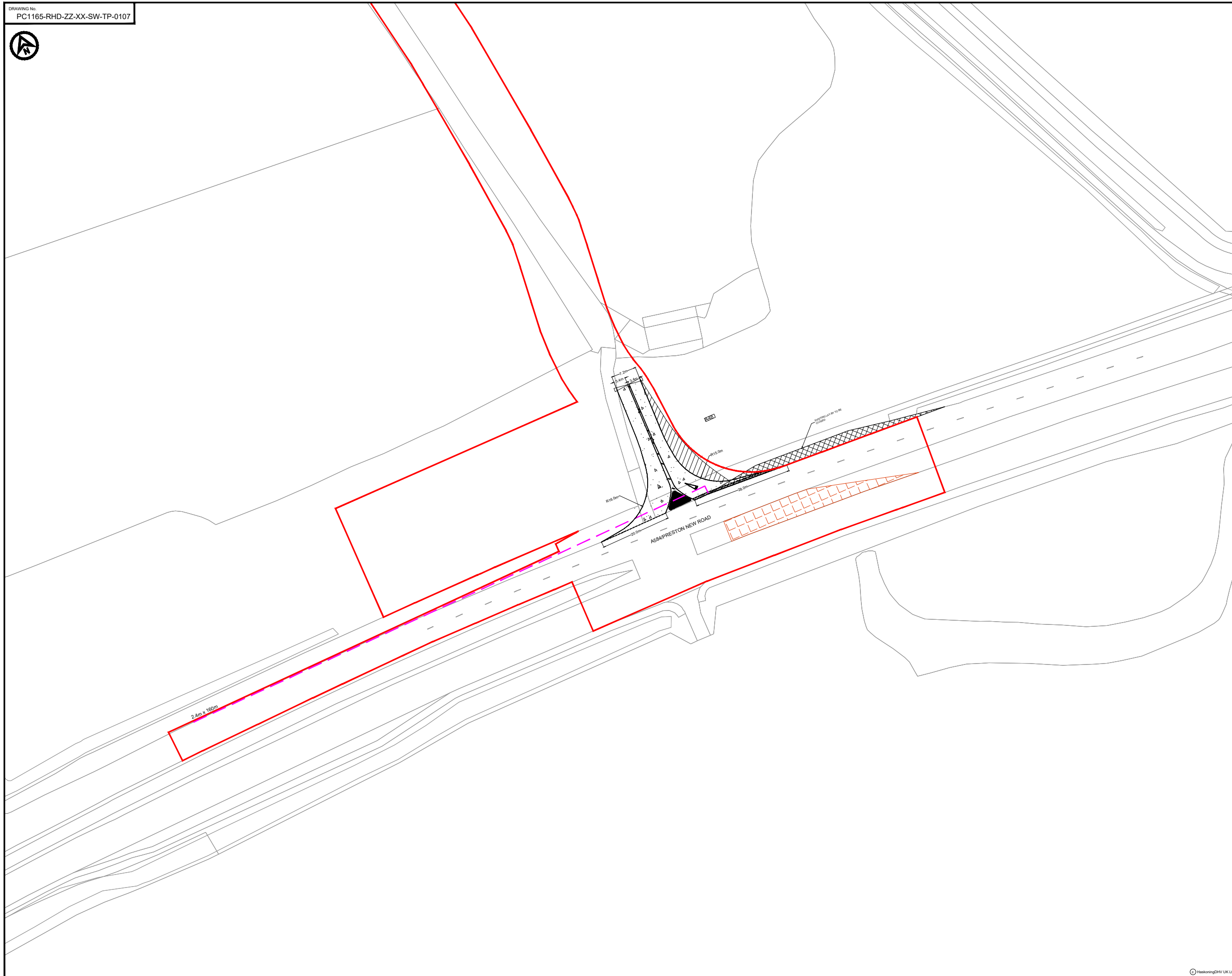

- NOTES**
1. Do not scale from this drawing, all dimensions are in metres unless noted otherwise.
  2. This drawing has been based upon Ordnance Survey Maps and Royal HaskoningDHV can not guarantee the accuracy of data.
  3. X-Distance - the set back from the nearest edge of the carriageway from which the access will be taken
  4. Y-Distance - the SSD measured along the nearest edge of the carriageway to its intersection with the centreline of the access. All vegetation to be cleared/trimmed within identified visibility envelope and thereafter maintained in accordance with Local Highway Authority maintenance practices.

**KEY**

- EXISTING ARRANGEMENT
- PROPOSED ACCESS BOUNDARY/ROAD MARKINGS
- VISIBILITY SPLAY FOR ASSUMED JUNCTION LOCATION
- MORGAN AND MORECAMBE ORDER LIMITS
- ▨ FULL DEPTH CARRIAGEWAY CONSTRUCTION WITH BOUND SURFACE
- ▨ PROPOSED EXTENTS OF JUNCTION WIDENING
- ▨ EXISTING LAY-BY TO BE CLOSED
- ▨ PROPOSED EXTENTS OF CENTRAL ISLAND TO BE REMOVED
- ▨ PROPOSED GATE

REV	DATE	DESCRIPTION	BY	CHK	APP
P03	03.05.24	UPDATED WORK AREA AND ORDER LIMITS	AA	SKT	SKT
P02	25.03.24	UPDATED M&M ACCESS TRACK	AA	SKT	SKT
P01	05.12.23	FIRST ISSUE	AA	SKT	SKT

REVISIONS

CLIENT

MORECAMBE OFFSHORE WIND FARM LTD AND MORGAN OFFSHORE WINDFARM LTD

PROJECT

MORGAN AND MORECAMBE OFFSHORE WIND FARMS TRANSMISSION ASSETS

**A48 ACCESS GENERAL ARRANGEMENT**



DRAWN	CHECKED	APPROVED
AA	SKT	SKT
DATE: 05.12.23	SCALE AT A3: 1:1000	AUTOCAD REF:
DRAWING No: PC1165-RHD-ZZ-XX-SW-TP-0107	REVISION	
CLIENT DWG No:		P03



**NOTES**  
 1. Do not scale from this drawing, all dimensions are in metres unless noted otherwise.  
 2. This drawing has been based upon Ordnance Survey Maps and Royal HaskoningDHV can not guarantee the accuracy of data.

**KEY**

- EXISTING ARRANGEMENT
- PROPOSED ACCESS BOUNDARY/ROAD MARKINGS
- MORGAN AND MORECAMBE ORDER LIMITS
- ◁ PROPOSED GATE

**VEHICLE TRACKING**

Max Legal Length (UK) Articulated Vehicle (16.5m)  
 Overall Length 16.500m  
 Overall Width 2.550m  
 Overall Body Height 3.881m  
 Min Body Ground Clearance 0.411m  
 Max Track Width 2.500m  
 Lock to lock time 6.90s  
 Kerb to Kerb Turning Radius 6.530m

▨ VEHICLE BODY SWEPT PATH (FORWARD GEAR)  
 — VEHICLE CHASSIS SWEPT PATH

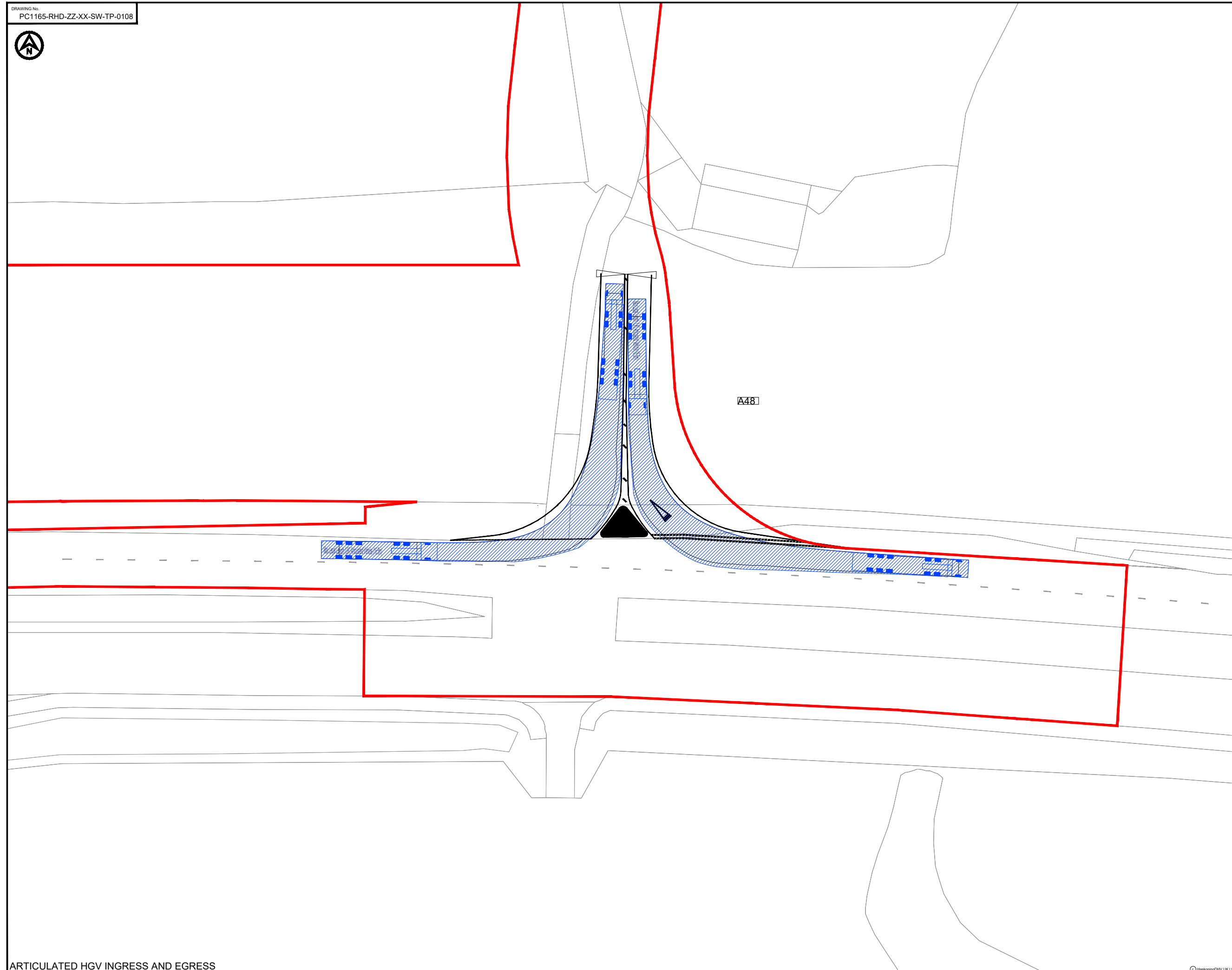

REV	DATE	DESCRIPTION	BY	CHK	APP
P02	25.03.24	UPDATED M&M ACCESS TRACK	AA	SKT	SKT
P01	05.12.23	FIRST ISSUE	AA	SKT	SKT

REVISIONS

CLIENT

**MORECAMBE OFFSHORE WIND FARM LTD AND MORGAN OFFSHORE WINDFARM LTD**

**PROJECT**  
 MORGAN AND MORECAMBE OFFSHORE WIND FARMS TRANSMISSION ASSETS

**TITLE**  
 A48 ACCESS SWEPT PATH ANALYSIS



DRAWN	CHECKED	APPROVED
AA	SKT	SKT
DATE	SCALE AT A3	AUTOCAD REF.
05.12.23	1:500	
DRAWING No.	PC1165-RHD-ZZ-XX-SW-TP-0108	REVISION
CLIENT DWG No.		P01



**NOTES**  
 1. Do not scale from this drawing, all dimensions are in metres unless noted otherwise.  
 2. This drawing has been based upon Ordnance Survey Maps and Royal HaskoningDHV can not guarantee the accuracy of data.

**KEY**

- EXISTING ARRANGEMENT
- PROPOSED ACCESS BOUNDARY/ROAD MARKINGS
- MORGAN AND MORECAMBE ORDER LIMITS
- ▨ PROPOSED EXTENTS OF JUNCTION WIDENING
- ▤ PROPOSED EXTENTS OF CENTRAL ISLAND TO BE REMOVED
- ◊ PROPOSED GATE

**VEHICLE TRACKING**

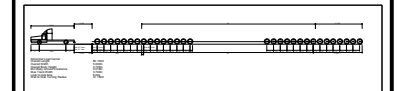

Abnormal Load Carrier	80.103m
Overall Length	5.950m
Overall Body Height	3.750m
Min Body Ground Clearance	0.018m
Max Track Width	3.700m
Lock to lock time	6.00s
Wall to Wall Turning Radius	31.150m

▨ VEHICLE BODY SWEEP PATH (FORWARD GEAR)  
 — VEHICLE CHASSIS SWEEP PATH

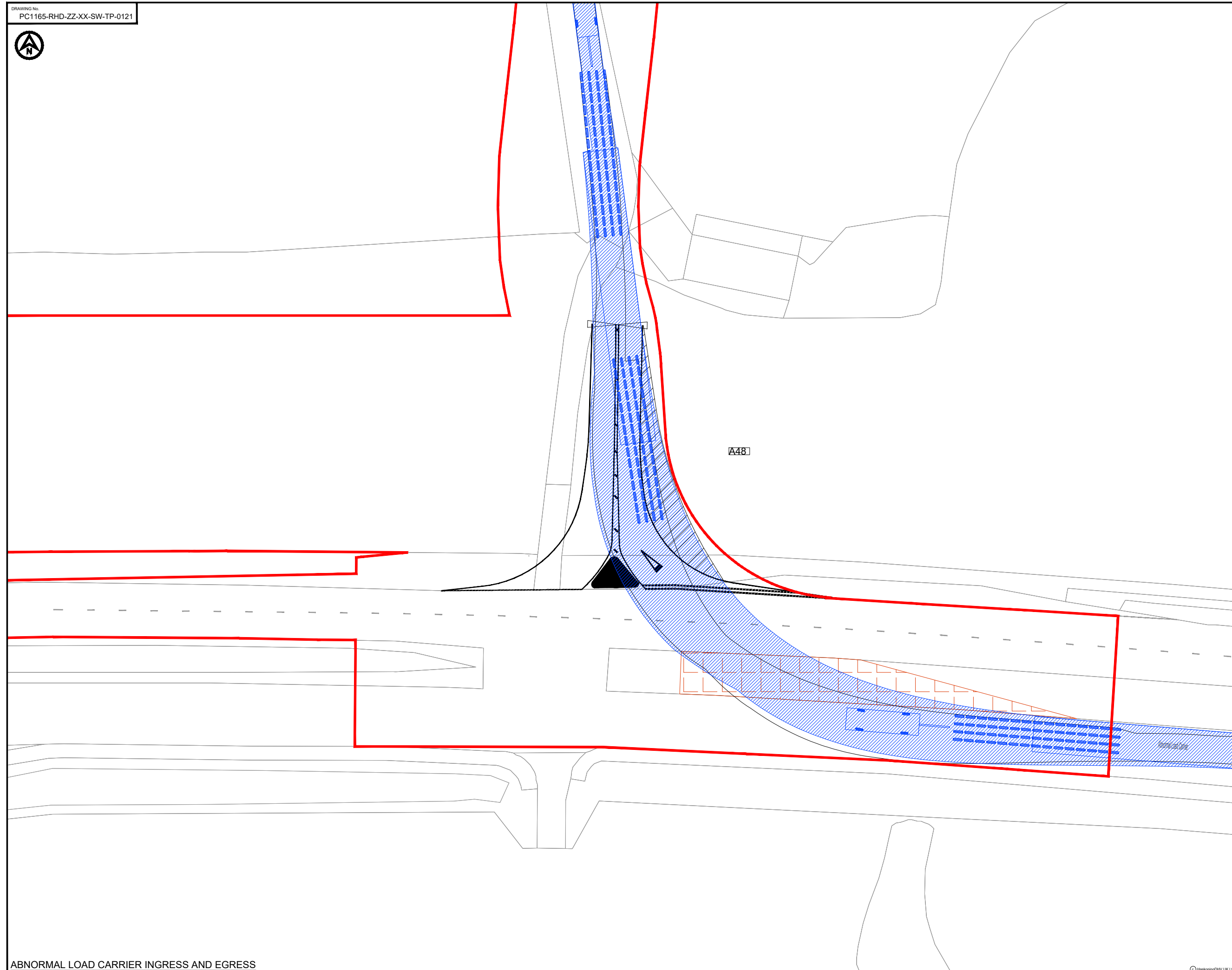

REV	DATE	DESCRIPTION	BY	CHK	APP
P02	25.03.24	UPDATED M&M ACCESS TRACK	AA	SKT	SKT
P01	11.12.23	FIRST ISSUE	AA	SKT	SKT

**REVISIONS**

**CLIENT**

**MORECAMBE OFFSHORE WIND FARM LTD AND MORGAN OFFSHORE WINDFARM LTD**

**PROJECT**

**MORGAN AND MORECAMBE OFFSHORE WIND FARMS TRANSMISSION ASSETS**

**A48 ACCESS SWEEP PATH ANALYSIS - ABNORMAL LOAD CARRIER**



DRAWN	AA	CHECKED	SKT	APPROVED	SKT
DATE	11.12.23	SCALE AT A3	1:500	AUTOCAD REF.	
DRAWING No.	PC1165-RHD-ZZ-XX-SW-TP-0121			REVISION	
CLIENT DWG No.				REVISION	P01

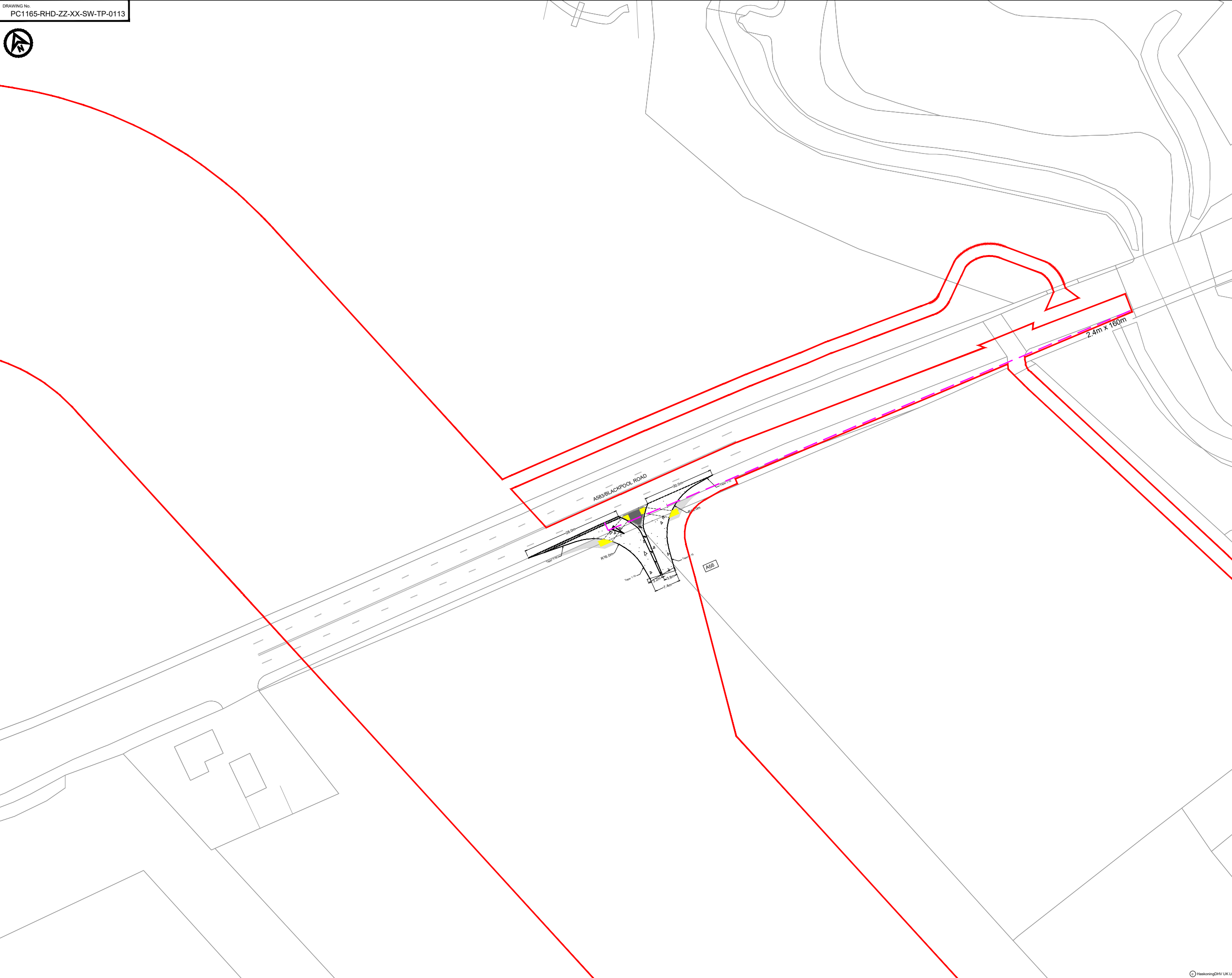

- NOTES**
1. Do not scale from this drawing, all dimensions are in metres unless noted otherwise.
  2. This drawing has been based upon Ordnance Survey Maps and Royal HaskoningDHV can not guarantee the accuracy of data.
  3. X-Distance - the set back from the nearest edge of the carriageway from which the access will be taken
  4. Y-Distance - the SSD measured along the nearest edge of the carriageway to its intersection with the centreline of the access.
  5. All vegetation to be cleared/trimmed within identified visibility envelope and thereafter maintained in accordance with Local Highway Authority maintenance practices.

**KEY**

- EXISTING ARRANGEMENT
- PROPOSED ACCESS BOUNDARY/ROAD MARKINGS
- VISIBILITY SPLAY FOR ASSUMED JUNCTION LOCATION
- MORGAN AND MORECAMBE ORDER LIMITS
- FULL DEPTH CARRIAGEWAY CONSTRUCTION WITH BOUND SURFACE
- PROPOSED NEW FOOTWAY FACILITY TO TIE INTO EXISTING NETWORK
- PROPOSED NEW UNCONTROLLED TACTILE CROSS OVER

REV	DATE	DESCRIPTION	BY	CHK	APP
P02	03.05.24	UPDATED WORK AREA AND ORDER LIMITS	AA	SKT	SKT
P01	06.12.23	FIRST ISSUE	AA	SKT	SKT

REVISIONS

CLIENT

**MORECAMBE OFFSHORE WIND FARM LTD AND MORGAN OFFSHORE WINDFARM LTD**

PROJECT

**MORGAN AND MORECAMBE OFFSHORE WIND FARMS TRANSMISSION ASSETS**

TITLE

**A56 ACCESS GENERAL ARRANGEMENT**



DRAWN	CHECKED	APPROVED
AA	SKT	SKT

DATE: 06.12.23 SCALE AT A3: 1:1000 AUTOCAD REF:

DRAWING No: PC1165-RHD-ZZ-XX-SW-TP-0113 REVISION: P02

CLIENT DWG No:



**NOTES**  
 1. Do not scale from this drawing, all dimensions are in metres unless noted otherwise.  
 2. This drawing has been based upon Ordnance Survey Maps and Royal HaskoningDHV can not guarantee the accuracy of data.

**KEY**

- EXISTING ARRANGEMENT
- PROPOSED ACCESS BOUNDARY/ROAD MARKINGS
- MORGAN AND MORECAMBE ORDER LIMITS
- PROPOSED NEW FOOTWAY FACILITY TO TIE INTO EXISTING NETWORK
- PROPOSED NEW UNCONTROLLED TACTILE CROSS OVER

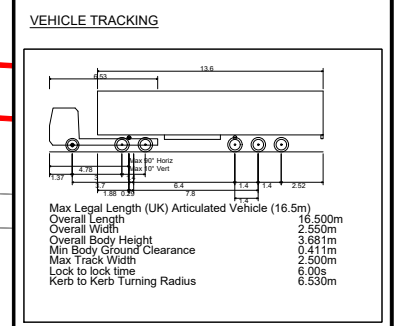

■ VEHICLE BODY SWEEP PATH (FORWARD GEAR)  
 — VEHICLE CHASSIS SWEEP PATH

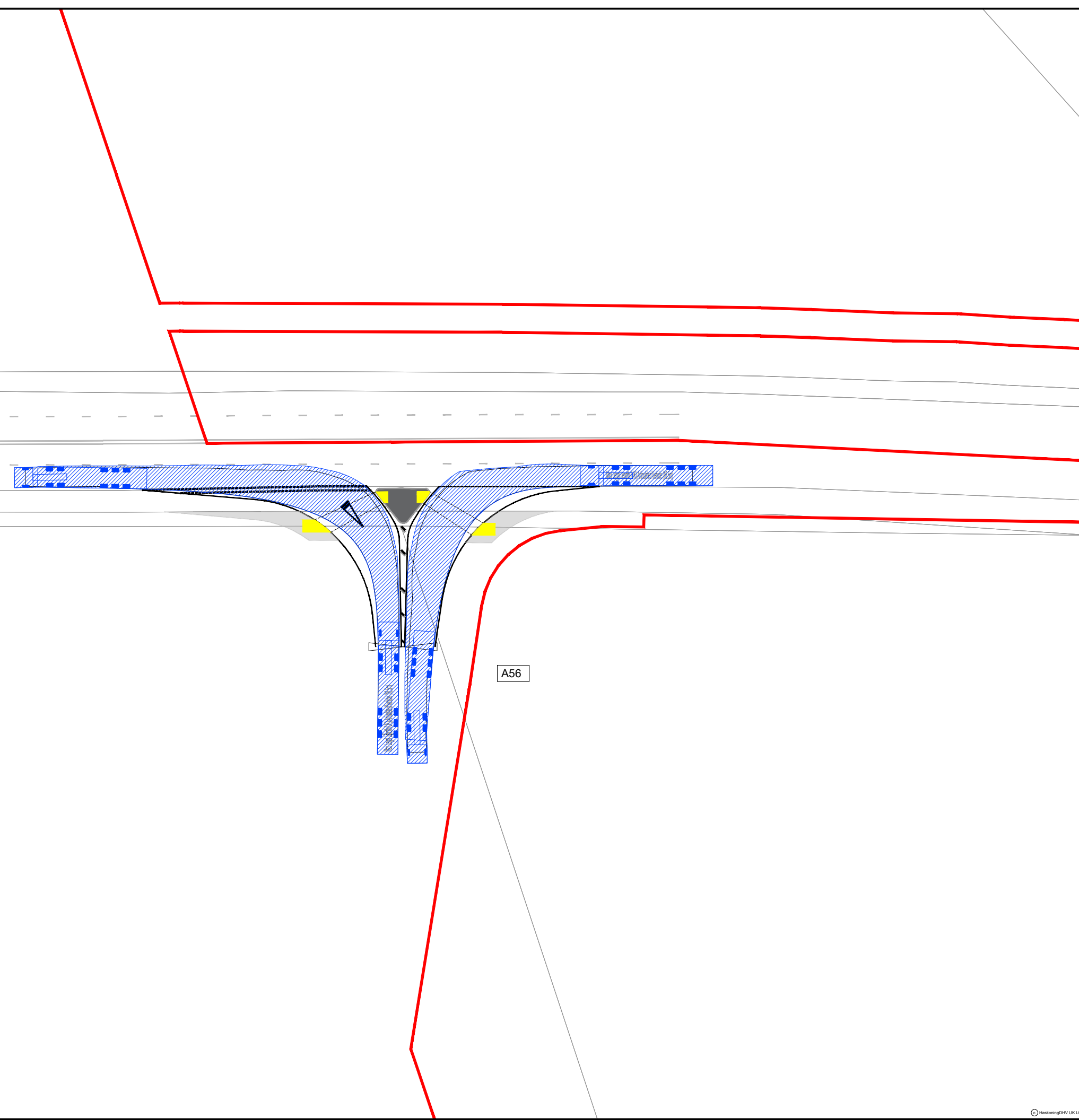

REV	DATE	DESCRIPTION	BY	CHK	APP
P01	06.12.23	FIRST ISSUE	AA	SKT	SKT

REVISIONS

CLIENT

**MORECAMBE OFFSHORE WIND FARM LTD AND MORGAN OFFSHORE WINDFARM LTD**

**PROJECT**  
 MORGAN AND MORECAMBE OFFSHORE WIND FARMS TRANSMISSION ASSETS

**TITLE**  
 A56 ACCESS SWEEP PATH ANALYSIS



DRAWN	CHECKED	APPROVED
AA	SKT	SKT
DATE	SCALE AT A3	AUTOCAD REF.
06.12.23	1:500	
DRAWING No.	PC1165-RHD-ZZ-XX-SW-TP-0114	REVISION
CLIENT DWG No.		P01





- NOTES**
1. Do not scale from this drawing, all dimensions are in metres unless noted otherwise.
  2. This drawing has been based upon Ordnance Survey Maps and Royal HaskoningDHV can not guarantee the accuracy of data.
  3. X-Distance - the set back from the nearest edge of the carriageway from which the access will be taken
  4. Y-Distance - the SSD measured along the nearest edge of the carriageway to its intersection with the centreline of the access.
  5. All vegetation to be cleared/trimmed within identified visibility envelope and thereafter maintained in accordance with Local Highway Authority maintenance practices.

**KEY**

	EXISTING ARRANGEMENT
	PROPOSED ACCESS BOUNDARY/ROAD MARKINGS
	MORGAN AND MORECAMBE ORDER LIMITS

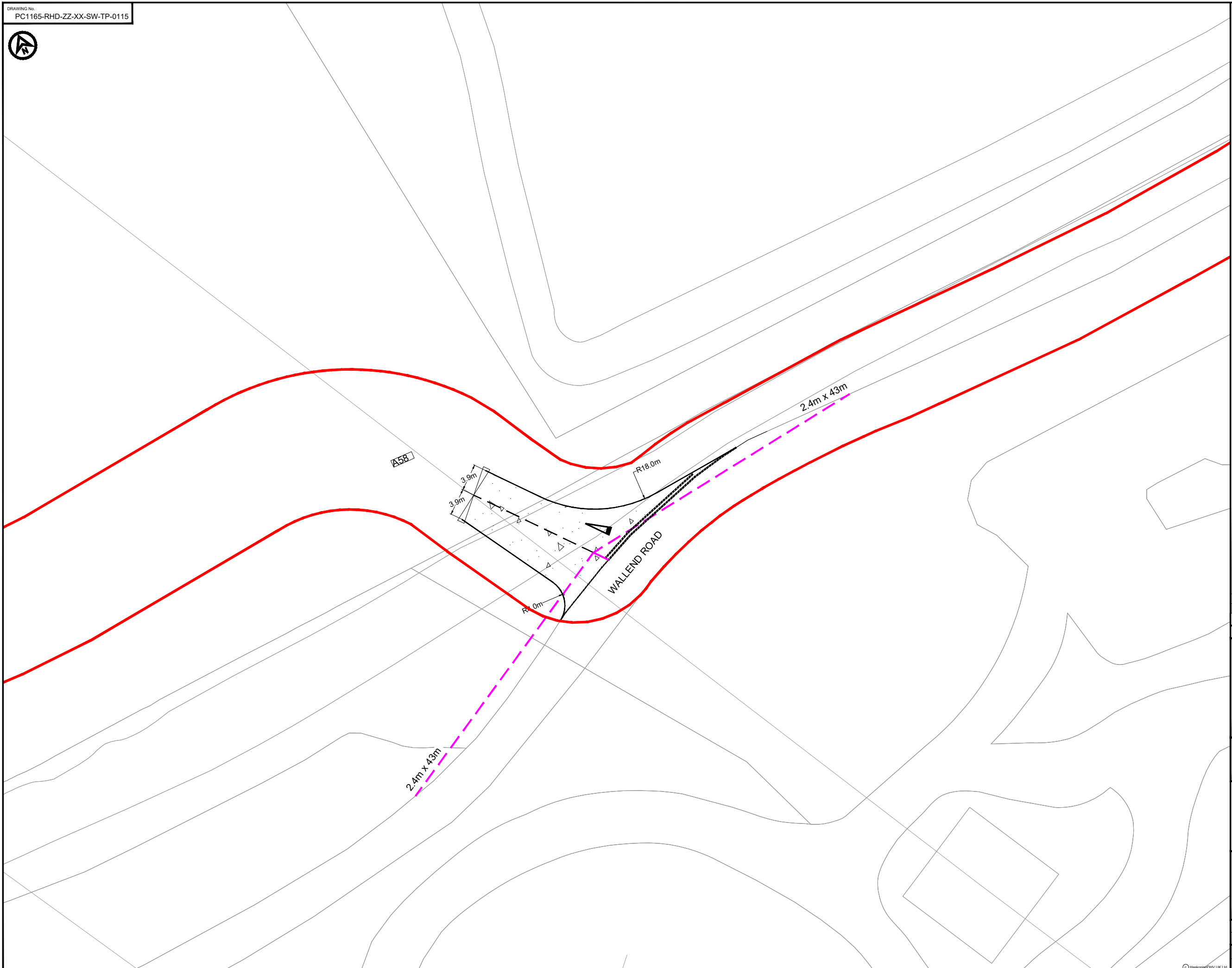

REV	DATE	DESCRIPTION	BY	CHK	APP
P02	03.05.24	UPDATED WORK AREA AND ORDER LIMITS	AA	SKT	SKT
P01	06.12.23	FIRST ISSUE	AA	SKT	SKT

REVISIONS

CLIENT

**MORECAMBE OFFSHORE WIND FARM LTD AND MORGAN OFFSHORE WINDFARM LTD**

**PROJECT**  
MORGAN AND MORECAMBE OFFSHORE WIND FARMS TRANSMISSION ASSETS

**TITLE**  
A58 ACCESS  
GENERAL ARRANGEMENT



DRAWN	CHECKED	APPROVED
AA	SKT	SKT
DATE	SCALE AT A3	AUTOCAD REF.
06.12.23	1:500	
DRAWING No.	PC1165-RHD-ZZ-XX-SW-TP-0115	REVISION
CLIENT DWG No.		P02



**NOTES**  
 1. Do not scale from this drawing, all dimensions are in metres unless noted otherwise.  
 2. This drawing has been based upon Ordnance Survey Maps and Royal HaskoningDHV can not guarantee the accuracy of data.

**KEY**

- EXISTING ARRANGEMENT
- PROPOSED ACCESS BOUNDARY/ROAD MARKINGS
- MORGAN AND MORECAMBE ORDER LIMITS

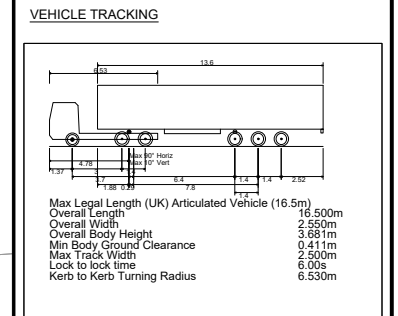

▨ VEHICLE BODY SWEEP PATH (FORWARD GEAR)  
 — VEHICLE CHASSIS SWEEP PATH

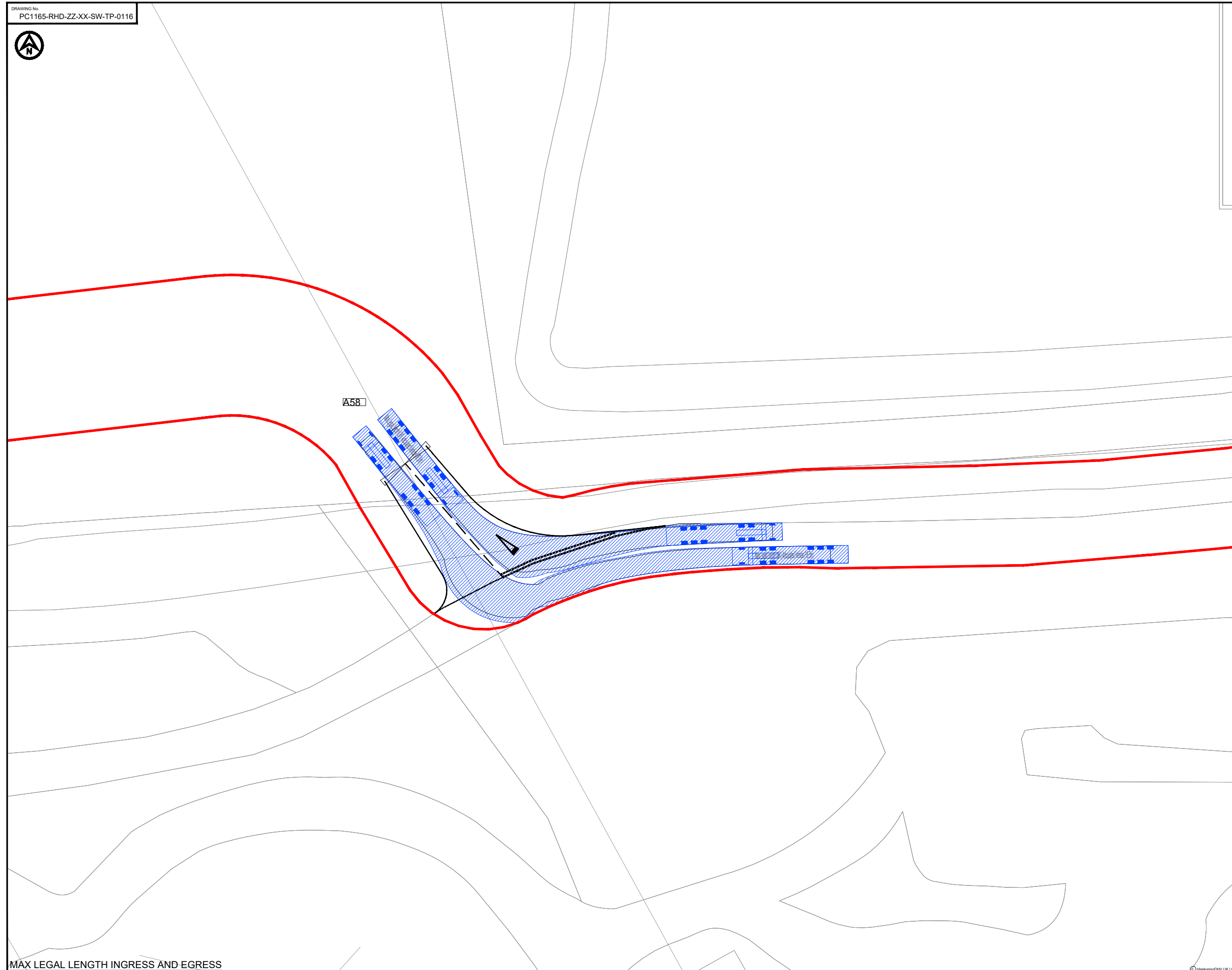

REV	DATE	DESCRIPTION	BY	CHK	APP
P01	06.12.23	FIRST ISSUE	AA	SKT	SKT

REVISIONS

CLIENT

**MORECAMBE OFFSHORE WIND FARM LTD AND MORGAN OFFSHORE WINDFARM LTD**

**PROJECT**  
 MORGAN AND MORECAMBE OFFSHORE WIND FARMS TRANSMISSION ASSETS

**TITLE**  
 A58 ACCESS SWEEP PATH ANALYSIS



DRAWN	CHECKED	APPROVED
AA	SKT	SKT
DATE	SCALE AT A3	AUTOCAD REF.
06.12.23	1:500	
DRAWING No.	PC1165-RHD-ZZ-XX-SW-TP-0116	REVISION
CLIENT DWG No.		P01

DRAWING No.  
PC1165-RHD-ZZ-XX-SW-TP-0126

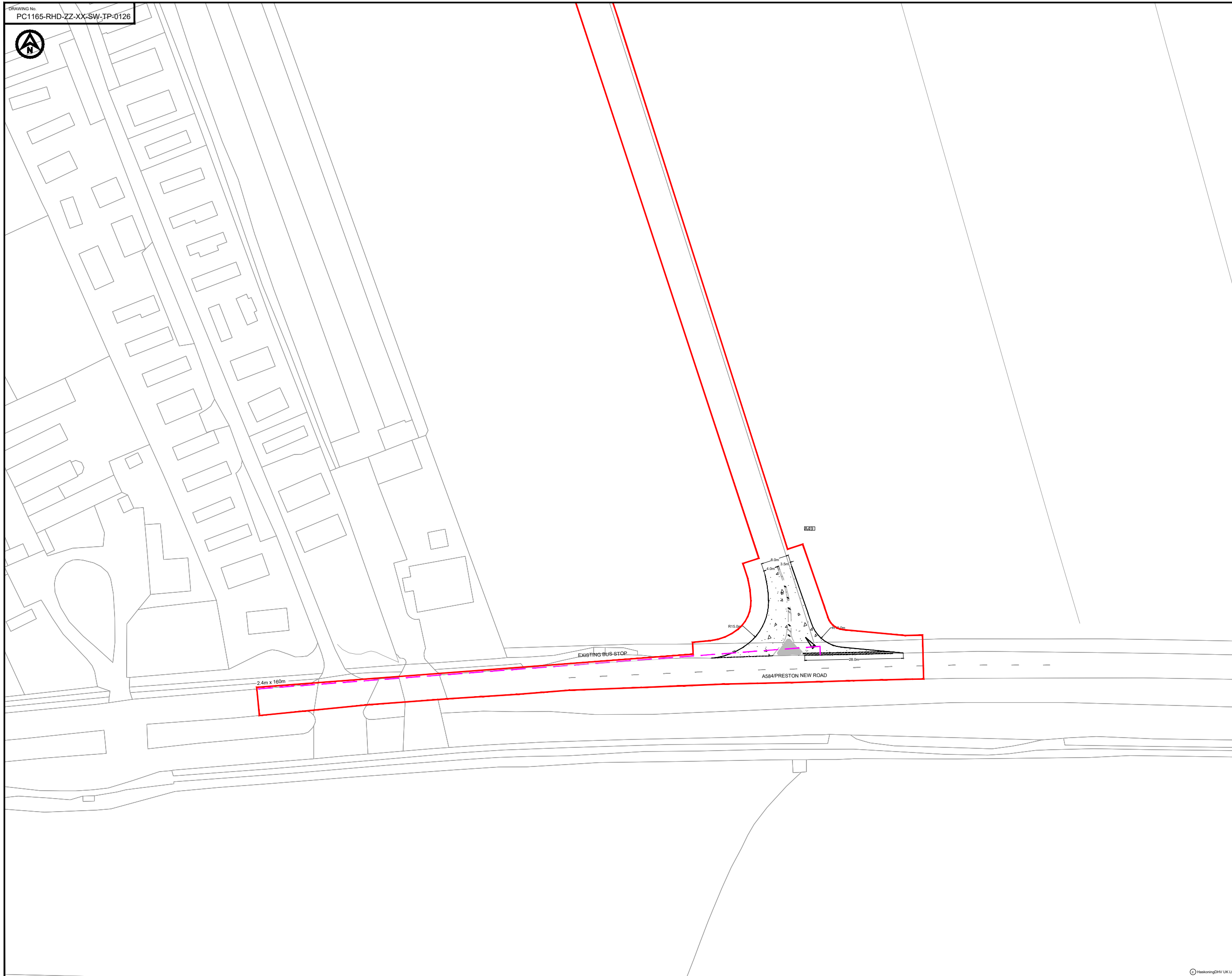

- NOTES**
1. Do not scale from this drawing, all dimensions are in metres unless noted otherwise.
  2. This drawing has been based upon Ordnance Survey Maps and Royal HaskoningDHV can not guarantee the accuracy of data.
  3. X-distance - the set back from the nearest edge of the carriageway from which the access will be taken
  4. Y-Distance - the SSD measured along the nearest edge of the carriageway to its intersection with the centreline of the access.
  5. All vegetation to be cleared/trimmed within identified visibility envelope and thereafter maintained in accordance with Local Highway Authority maintenance practices.

**KEY**

- EXISTING ARRANGEMENT
- PROPOSED ACCESS BOUNDARY/ROAD MARKINGS
- - - VISIBILITY SPLAY FOR ASSUMED JUNCTION LOCATION
- MORGAN AND MORECAMBE ORDER LIMITS
- FULL DEPTH CARRIAGEWAY CONSTRUCTION WITH BOUND SURFACE

REV	DATE	DESCRIPTION	BY	CHK	APP
P02	03.05.24	UPDATED WORK AREA AND ORDER LIMITS	AA	SKT	SKT
P01	13.12.23	FIRST ISSUE	AA	SKT	SKT

REVISIONS

CLIENT

MORECAMBE OFFSHORE WIND FARM LTD AND MORGAN OFFSHORE WINDFARM LTD

PROJECT  
MORGAN AND MORECAMBE OFFSHORE WIND FARMS TRANSMISSION ASSETS

TITLE  
ACCESS A49  
GENERAL ARRANGEMENT



DRAWN	CHECKED	APPROVED
AA	SKT	SKT
DATE	SCALE AT A3	AUTOCAD REF.
13.12.23	1:1000	
DRAWING No.	PC1165-RHD-ZZ-XX-SW-TP-0126	REVISION
CLIENT DWG No.		P02



**NOTES**  
 1. Do not scale from this drawing, all dimensions are in metres unless noted otherwise.  
 2. This drawing has been based upon Ordnance Survey Maps and Royal HaskoningDHV can not guarantee the accuracy of data.

**KEY**

- EXISTING ARRANGEMENT
- PROPOSED ACCESS BOUNDARY/ROAD MARKINGS
- MORGAN AND MORECAMBE ORDER LIMITS

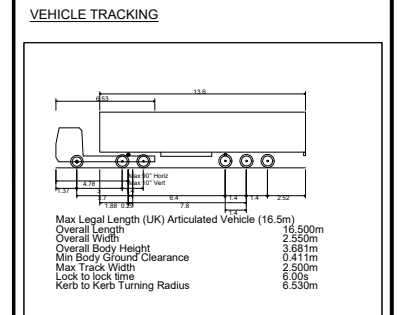

VEHICLE BODY SWEEP PATH (FORWARD GEAR)  
 VEHICLE CHASSIS SWEEP PATH

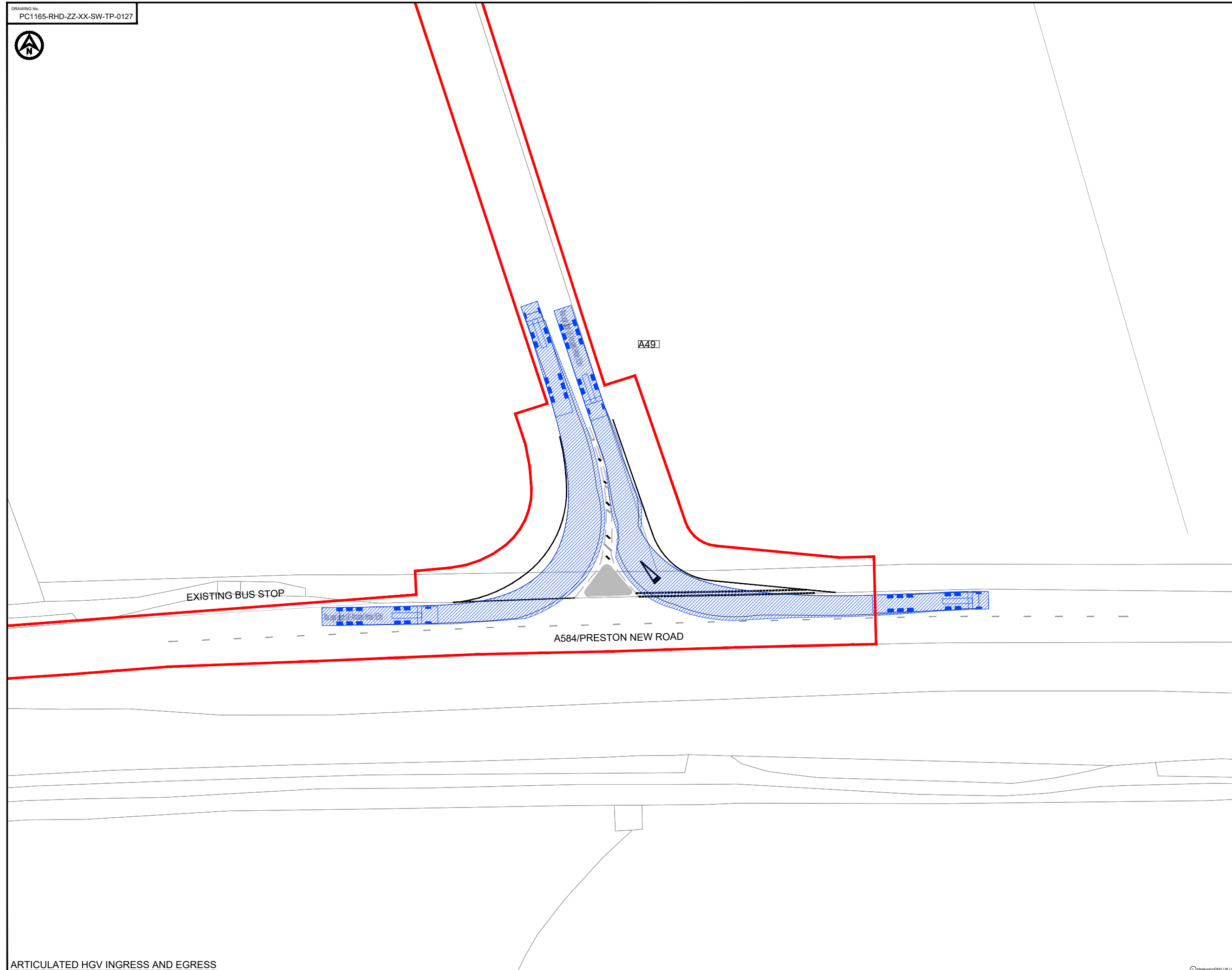

P01	12.12.23	FIRST ISSUE	AA	SKT	SKT
REV	DATE	DESCRIPTION	BY	CHK	APP

REVISIONS

CLIENT

**MORECAMBE OFFSHORE WIND FARM LTD AND MORGAN OFFSHORE WINDFARM LTD**

**MORGAN AND MORECAMBE OFFSHORE WIND FARMS TRANSMISSION ASSETS**

**ACCESS A49 SWEEP PATH ANALYSIS**



DRAWN	AA	CHECKED	SKT	APPROVED	SKT
DATE	13.12.23	SCALE AT A3	1:500	AUTOCAD REF.	
DRAWING No.	PC1165-RHD-ZZ-XX-SW-TP-0127			REVISION	
CLIENT DWG No.				REVISION	P01

DRAWING No.  
PC1165-RHD-ZZ-XX-SW-TP-0006

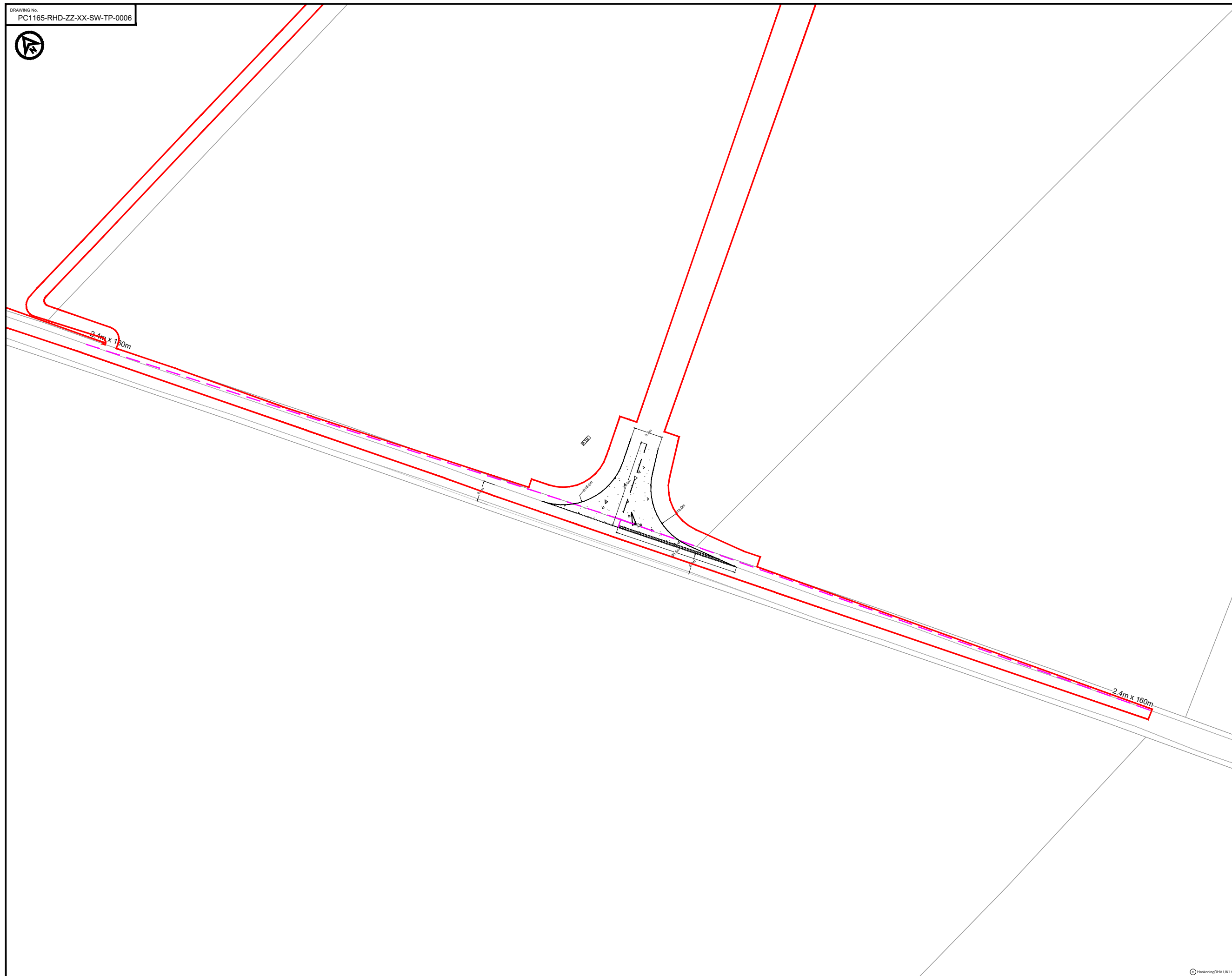

- NOTES**
1. Do not scale from this drawing, all dimensions are in metres unless noted otherwise.
  2. This drawing has been based upon Ordnance Survey Maps and Royal HaskoningDHV can not guarantee the accuracy of data.
  3. X-distance - the set back from the nearest edge of the carriageway from which the access will be taken
  4. Y-Distance - the SSD measured along the nearest edge of the carriageway to its intersection with the centreline of the access.
  5. All vegetation to be cleared/trimmed within identified visibility envelope and thereafter maintained in accordance with Local Highway Authority maintenance practices.

- KEY**
- EXISTING ARRANGEMENT
  - PROPOSED ACCESS BOUNDARY/ROAD MARKINGS
  - - - VISIBILITY SPLAY FOR ASSUMED JUNCTION LOCATION
  - MORGAN AND MORECAMBE ORDER LIMITS
  - FULL DEPTH CARRIAGEWAY CONSTRUCTION WITH BOUND SURFACE

REV	DATE	DESCRIPTION	BY	CHK	APP
P02	01.05.24	UPDATED WORK AREA AND ORDER LIMITS	AA	SKT	SKT
P01	12.01.24	FIRST ISSUE	AA	SKT	SKT

REVISIONS

CLIENT

**MORECAMBE OFFSHORE WIND FARM LTD AND MORGAN OFFSHORE WINDFARM LTD**

**PROJECT**  
MORGAN AND MORECAMBE OFFSHORE WIND FARMS TRANSMISSION ASSETS

**TITLE**  
ACCESS A19  
GENERAL ARRANGEMENT



DRAWN	CHECKED	APPROVED
AA	SKT	SKT
DATE	SCALE AT A3	AUTOCAD REF.
12.01.2024	1:1000	
DRAWING No.	PC1165-RHD-ZZ-XX-SW-TP-0006	REVISION
CLIENT DWG No.		P02



**NOTES**  
 1. Do not scale from this drawing, all dimensions are in metres unless noted otherwise.  
 2. This drawing has been based upon Ordnance Survey Maps and Royal HaskoningDHV can not guarantee the accuracy of data.

**KEY**  
 — EXISTING ARRANGEMENT  
 — PROPOSED ACCESS BOUNDARY/ROAD MARKINGS  
 — MORGAN AND MORECAMBE ORDER LIMITS

**VEHICLE TRACKING**

Max Legal Length (UK) Articulated Vehicle (16.5m)  
 Overall Length 15.500m  
 Overall Width 2.550m  
 Overall Body Height 3.581m  
 Min Body Ground Clearance 0.411m  
 Max Track Width 2.500m  
 Lock to lock time 6.00s  
 Kerb to Kerb Turning Radius 6.530m

▨ VEHICLE BODY SWEEP PATH (FORWARD GEAR)  
 — VEHICLE CHASSIS SWEEP PATH

A19

A19

REV	DATE	DESCRIPTION	BY	CHK	APP
P01	12.01.24	FIRST ISSUE	AA	SKT	SKT

REVISIONS

CLIENT

**MORECAMBE OFFSHORE WIND FARM LTD AND MORGAN OFFSHORE WINDFARM LTD**

**MORGAN AND MORECAMBE OFFSHORE WIND FARMS TRANSMISSION ASSETS**

**ACCESS A19 SWEEP PATH ANALYSIS**



DRAWN	CHECKED	APPROVED
AA	SKT	SKT
DATE	SCALE AT A3	AUTOCAD REF.
12.01.2024	1:500	
DRAWING No. PC1165-RHD-ZZ-XX-SW-TP-0054	REVISION	
CLIENT DWG No.		P01

DRAWING No.  
PC1165-RHD-ZZ-XX-SW-TP-0005



- NOTES**
1. Do not scale from this drawing, all dimensions are in metres unless noted otherwise.
  2. This drawing has been based upon Ordnance Survey Maps and Royal HaskoningDHV can not guarantee the accuracy of data.
  3. X-distance - the set back from the nearest edge of the carriageway from which the access will be taken
  4. Y-Distance - the SSD measured along the nearest edge of the carriageway to its intersection with the centreline of the access.
  5. All vegetation to be cleared/trimmed within identified visibility envelope and thereafter maintained in accordance with Local Highway Authority maintenance practices.

- KEY**
- EXISTING ARRANGEMENT
  - PROPOSED ACCESS BOUNDARY/ROAD MARKINGS
  - - - VISIBILITY SPLAY FOR ASSUMED JUNCTION LOCATION
  - MORGAN AND MORECAMBE ORDER LIMITS
  - FULL DEPTH CARRIAGEWAY CONSTRUCTION WITH BOUND SURFACE

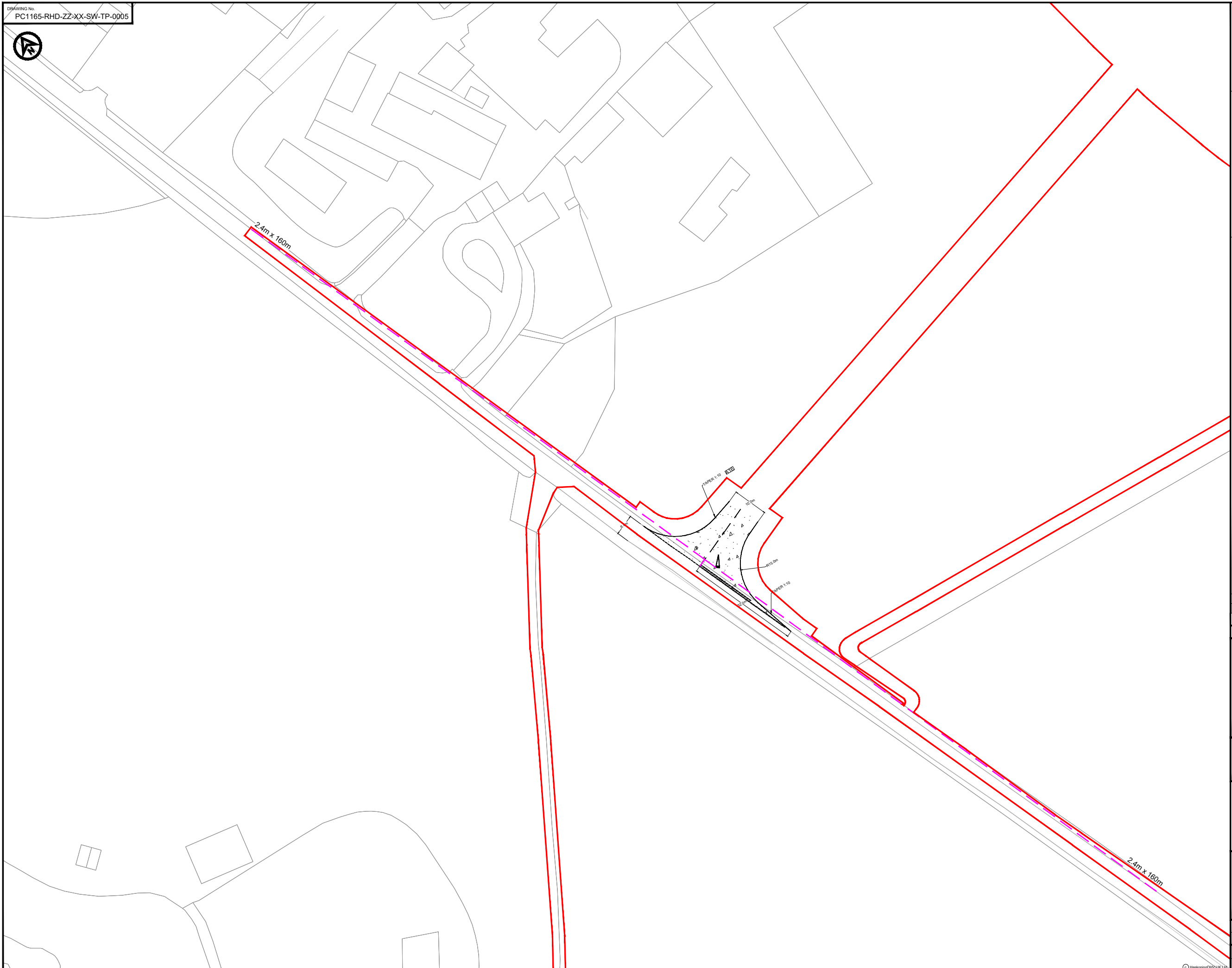

REV	DATE	DESCRIPTION	BY	CHK	APP
P02	01.05.24	UPDATED WORK AREA AND ORDER LIMITS	AA	SKT	SKT
P01	12.01.24	FIRST ISSUE	AA	SKT	SKT

REVISIONS

CLIENT

**MORECAMBE OFFSHORE WIND FARM LTD AND MORGAN OFFSHORE WINDFARM LTD**

**PROJECT**  
MORGAN AND MORECAMBE OFFSHORE WIND FARMS TRANSMISSION ASSETS

**TITLE**  
ACCESS A16 GENERAL ARRANGEMENT



DRAWN	CHECKED	APPROVED
AA	SKT	SKT
DATE	SCALE AT A3	AUTOCAD REF.
12.01.2024	1:1000	
DRAWING No.	PC1165-RHD-ZZ-XX-SW-TP-0005	REVISION
CLIENT DWG No.		P02



**NOTES**  
 1. Do not scale from this drawing, all dimensions are in metres unless noted otherwise.  
 2. This drawing has been based upon Ordnance Survey Maps and Royal HaskoningDHV can not guarantee the accuracy of data.

**KEY**  
 — EXISTING ARRANGEMENT  
 — PROPOSED ACCESS BOUNDARY/ROAD MARKINGS  
 — MORGAN AND MORECAMBE ORDER LIMITS

**VEHICLE TRACKING**

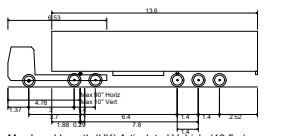

Max Legal Length (UK) Articulated Vehicle (16.5m)  
 Overall Length 15.500m  
 Overall Width 2.550m  
 Overall Body Height 3.581m  
 Min Body Ground Clearance 0.411m  
 Max Track Width 2.500m  
 Lock to lock time 6.00s  
 Kerb to Kerb Turning Radius 6.530m

▨ VEHICLE BODY SWEEP PATH (FORWARD GEAR)  
 — VEHICLE CHASSIS SWEEP PATH



ARTICULATED HGV INGRESS

ARTICULATED HGV EGRESS

REV	DATE	DESCRIPTION	BY	CHK	APP
P01	12.01.24	FIRST ISSUE	AA	SKT	SKT

REVISIONS

CLIENT

MORECAMBE OFFSHORE WIND FARM LTD AND MORGAN OFFSHORE WINDFARM LTD

PROJECT  
MORGAN AND MORECAMBE OFFSHORE WIND FARMS TRANSMISSION ASSETS

TITLE  
ACCESS A16 SWEEP PATH ANALYSIS



DRAWN	CHECKED	APPROVED
AA	SKT	SKT

DATE: 12.01.2024 SCALE AT A3 VARIES AUTOCAD REF. DRAWING No. PC1165-RHD-ZZ-XX-SW-TP-0053 REVISION CLIENT DWG No. P01





- NOTES**
1. Do not scale from this drawing, all dimensions are in metres unless noted otherwise.
  2. This drawing has been based upon Ordnance Survey Maps and Royal HaskoningDHV can not guarantee the accuracy of data.
  3. X-Distance - the set back from the nearest edge of the carriageway from which the access will be taken
  4. Y-Distance - the SSD measured along the nearest edge of the carriageway to its intersection with the centreline of the access.
  5. All vegetation to be cleared/trimmed within identified visibility envelope and thereafter maintained in accordance with Local Highway Authority maintenance practices.
  6. Requirement for diverge tapers to be determined once daily flows into access established.

- KEY**
- EXISTING ARRANGEMENT
  - PROPOSED ACCESS BOUNDARY/ROAD MARKINGS
  - VISIBILITY SPLAY FOR ASSUMED JUNCTION LOCATION
  - MORGAN AND MORECAMBE ORDER LIMITS
  - EXISTING CYCLE WAY
  - PROPOSED NEW UNCONTROLLED TACTILE CROSS OVER
  - FULL DEPTH CARRIAGEWAY CONSTRUCTION WITH BOUND SURFACE

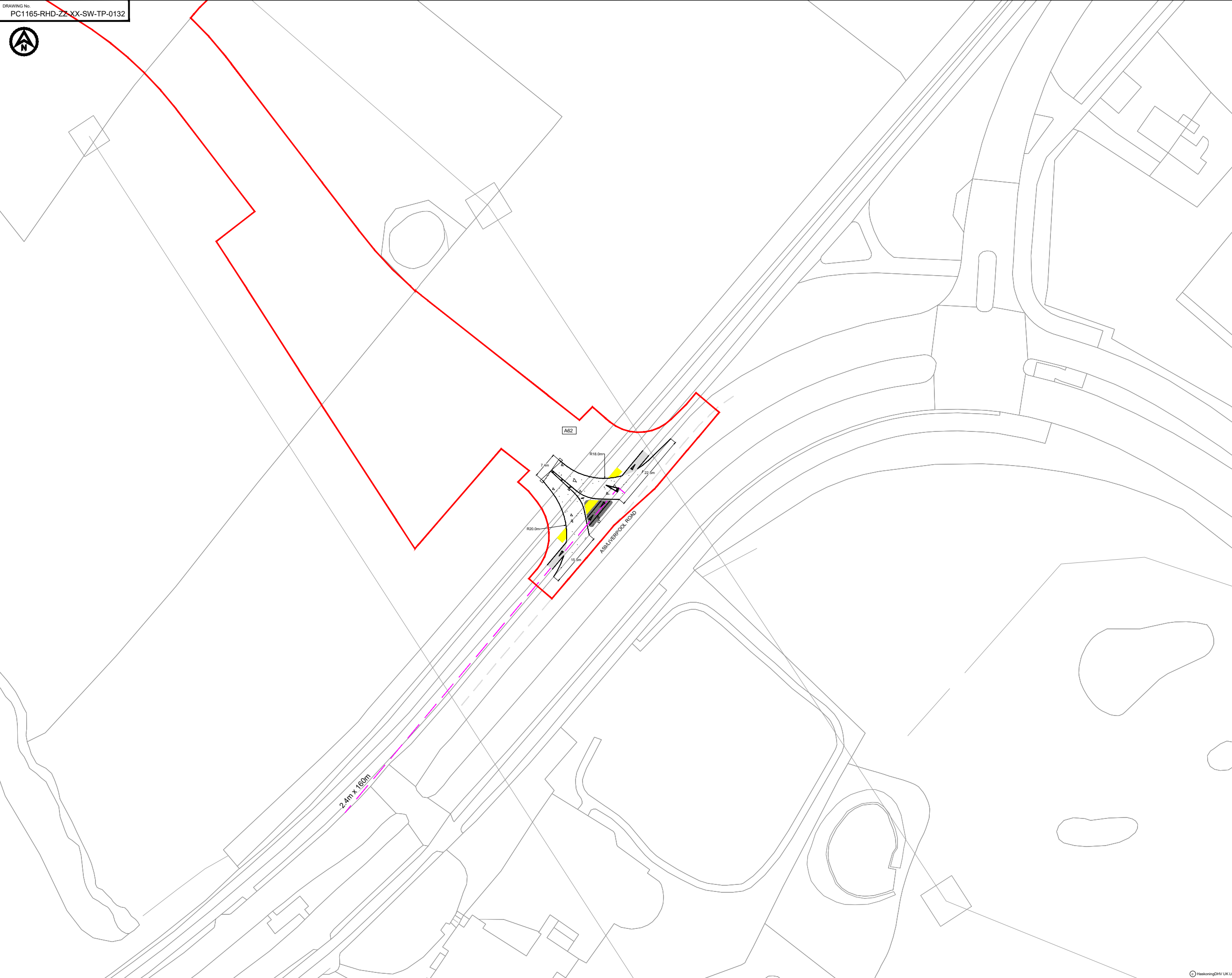

REV	DATE	DESCRIPTION	BY	CHK	APP
P02	03.05.24	UPDATED WORK AREA AND ORDER LIMITS	AA	SKT	SKT
P01	15.01.23	FIRST ISSUE	AA	SKT	SKT

REVISIONS

CLIENT

**MORECAMBE OFFSHORE WIND FARM LTD AND MORGAN OFFSHORE WINDFARM LTD**

**PROJECT**  
MORGAN AND MORECAMBE OFFSHORE WIND FARMS TRANSMISSION ASSETS

**TITLE**  
ACCESS A62  
GENERAL ARRANGEMENT



DRAWN	CHECKED	APPROVED
AA	SKT	SKT
DATE	SCALE AT A3	AUTOCAD REF.
15.01.24	1:1000	
DRAWING No.	PC1165-RHD-ZZ-XX-SW-TP-0132	REVISION
CLIENT DWG No.		P02

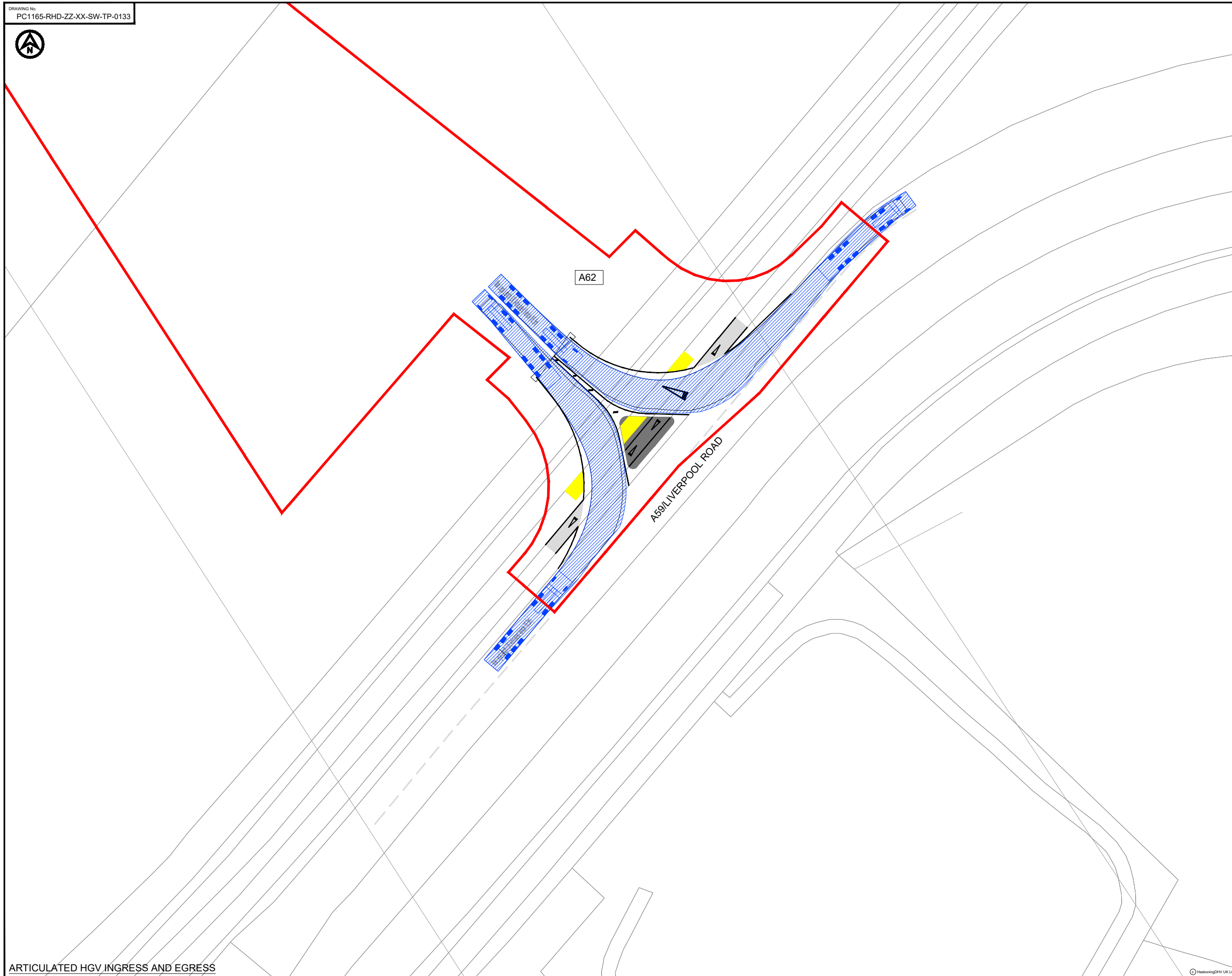

- NOTES**
1. Do not scale from this drawing, all dimensions are in metres unless noted otherwise.
  2. This drawing has been based upon Ordnance Survey Maps and Royal HaskoningDHV can not guarantee the accuracy of data.
  3. X-distance - the set back from the nearest edge of the carriageway from which the access will be taken
  4. Y-distance - the SSD measured along the nearest edge of the carriageway to its intersection with the centreline of the access.
  5. All vegetation to be cleared/trimmed within identified visibility envelope and thereafter maintained in accordance with Local Highway Authority maintenance practices.
  6. Requirement for diverge tapers to be determined once daily flows into access established.

**KEY**

- EXISTING ARRANGEMENT
- PROPOSED ACCESS BOUNDARY/ROAD MARKINGS
- MORGAN AND MORECAMBE ORDER LIMITS
- EXISTING CYCLE WAY
- PROPOSED NEW UNCONTROLLED TACTILE CROSS OVER

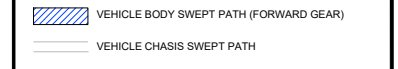
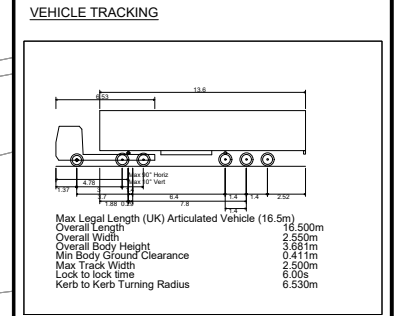

REV	DATE	DESCRIPTION	BY	CHK	APP
P01	15.01.24	FIRST ISSUE	AA	SKT	SKT

REVISIONS

CLIENT

**MORECAMBE OFFSHORE WIND FARM LTD AND MORGAN OFFSHORE WINDFARM LTD**

PROJECT

**MORGAN AND MORECAMBE OFFSHORE WIND FARMS TRANSMISSION ASSETS**

TITLE

**ACCESS A62 SWEEP PATH ANALYSIS**



DRAWN	CHECKED	APPROVED
AA	SKT	SKT
DATE	SCALE AT A3	AUTOCAD REF.
15.01.24	1:500	
DRAWING No.	PC1165-RHD-ZZ-XX-SW-TP-0133	REVISION
CLIENT DWG No.		P01

DRAWING No.  
PC1165-RHD-ZZ-XX-SW-TP-0134



- NOTES**
1. Do not scale from this drawing, all dimensions are in metres unless noted otherwise.
  2. This drawing has been based upon Ordnance Survey Maps and Royal HaskoningDHV can not guarantee the accuracy of data.
  3. X-distance - the set back from the nearest edge of the carriageway from which the access will be taken
  4. Y-Distance - the SSD measured along the nearest edge of the carriageway to its intersection with the centreline of the access.
  5. All vegetation to be cleared/trimmed within identified visibility envelope and thereafter maintained in accordance with Local Highway Authority maintenance practices.
  6. Requirement for diverge tapers to be determined once daily flows into access established.

- KEY**
- EXISTING ARRANGEMENT
  - PROPOSED ACCESS BOUNDARY/ROAD MARKINGS
  - VISIBILITY SPLAY FOR ASSUMED JUNCTION LOCATION
  - MORGAN AND MORECAMBE ORDER LIMITS
  - ▨ PROPOSED EXTENTS OF JUNCTION WIDENING

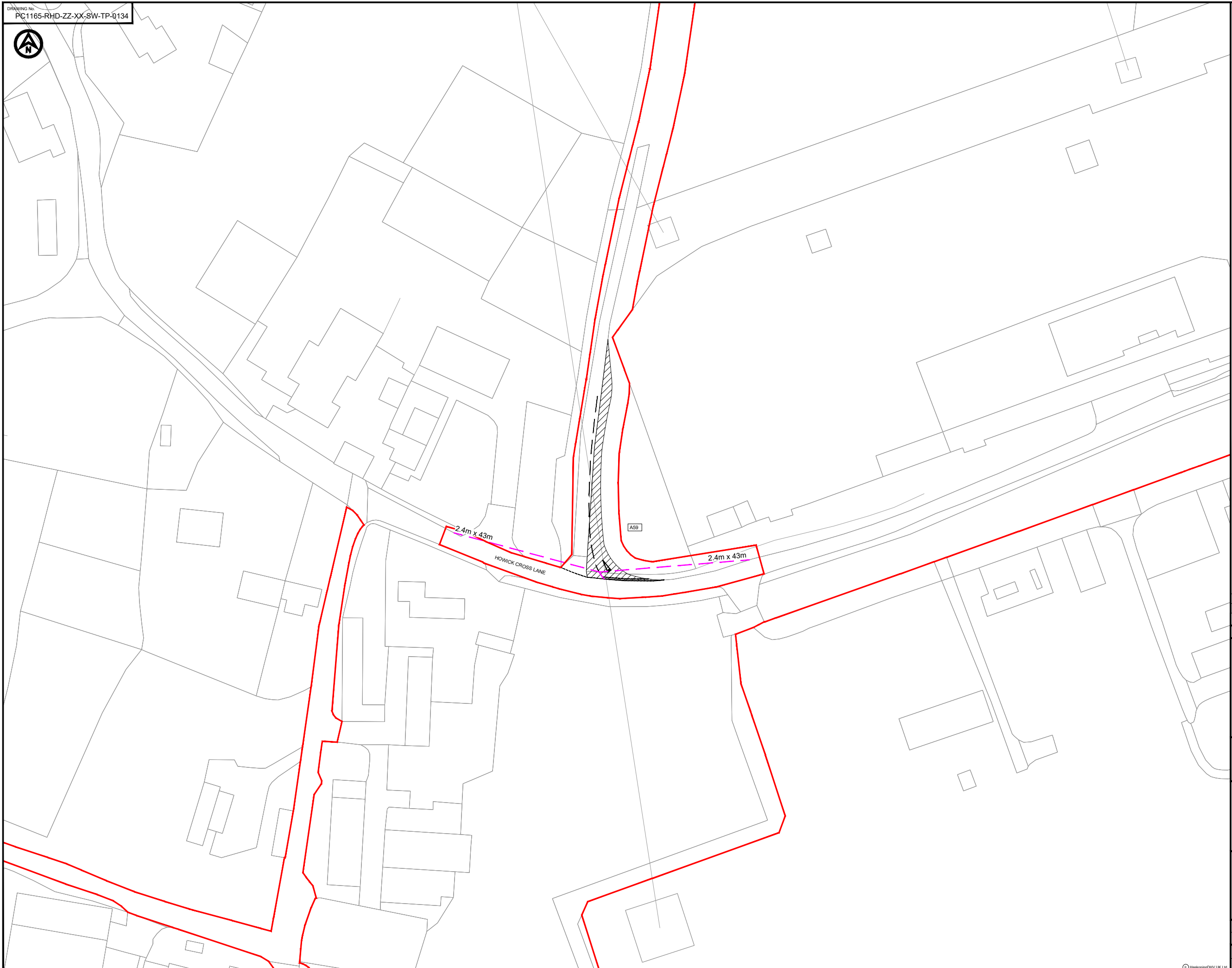

P02	03.05.24	UPDATED WORK AREA AND ORDER LIMITS	AA	SKT	SKT
P01	15.01.23	FIRST ISSUE	AA	SKT	SKT
REV	DATE	DESCRIPTION	BY	CHK	APP

REVISIONS

CLIENT

**MORECAMBE OFFSHORE WIND FARM LTD AND MORGAN OFFSHORE WINDFARM LTD**

**PROJECT**  
MORGAN AND MORECAMBE OFFSHORE WIND FARMS TRANSMISSION ASSETS

**TITLE**  
ACCESS A59  
GENERAL ARRANGEMENT



DRAWN	AA	CHECKED	SKT	APPROVED	SKT
DATE	15.01.24	SCALE AT AS	1:1000	AUTOCAD REF.	

DRAWING No.	PC1165-RHD-ZZ-XX-SW-TP-0134	REVISION	
CLIENT DWG No.			P02

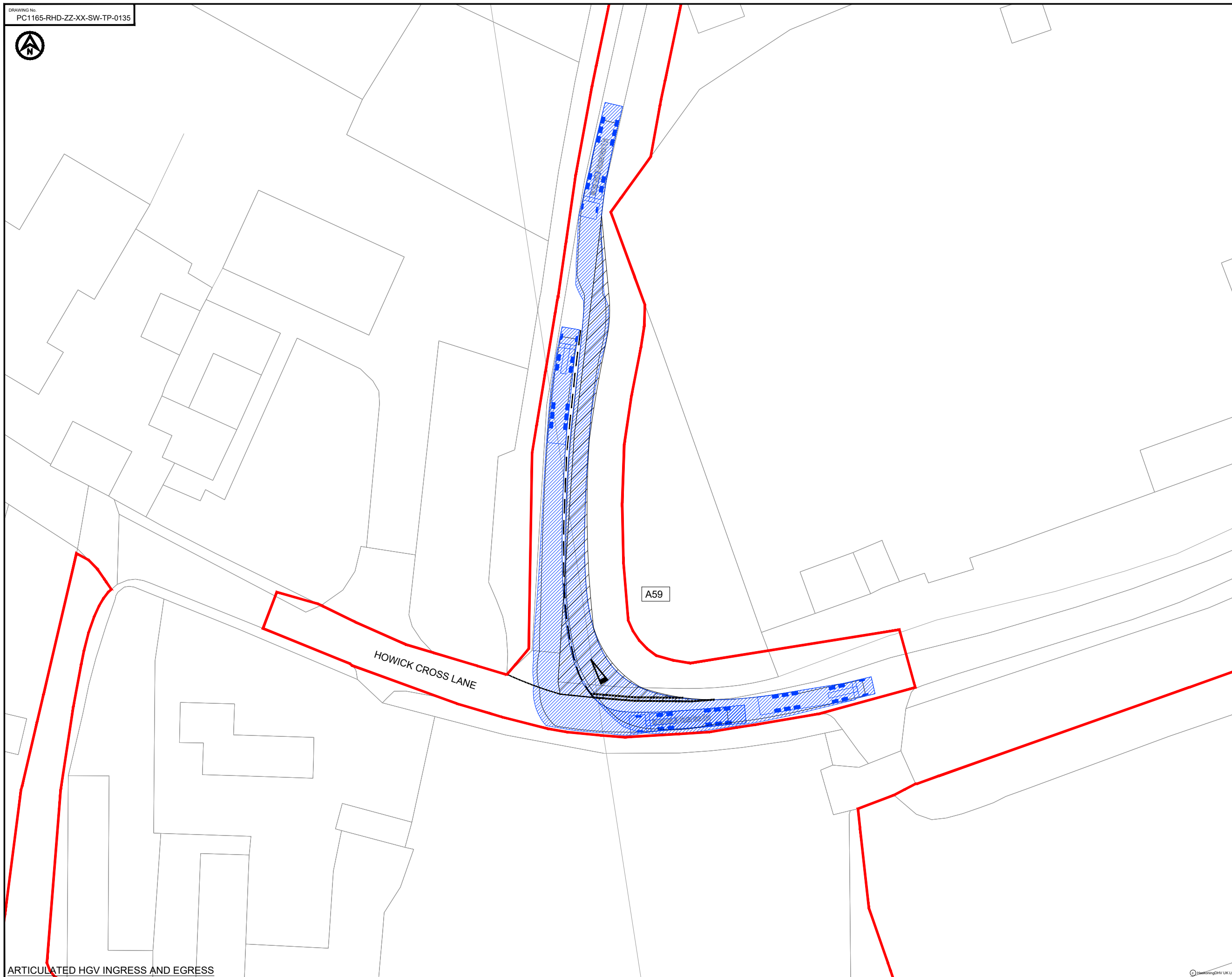

ARTICULATED HGV INGRESS AND EGRESS

- NOTES**
1. Do not scale from this drawing, all dimensions are in metres unless noted otherwise.
  2. This drawing has been based upon Ordnance Survey Maps and Royal HaskoningDHV can not guarantee the accuracy of data.
  3. X-distance - the set back from the nearest edge of the carriageway from which the access will be taken
  4. Y-Distance - the SSD measured along the nearest edge of the carriageway to its intersection with the centreline of the access.
  5. All vegetation to be cleared/trimmed within identified visibility envelope and thereafter maintained in accordance with Local Highway Authority maintenance practices.
  6. Requirement for diverge tapers to be determined once daily flows into access established.

**KEY**

- EXISTING ARRANGEMENT
- PROPOSED ACCESS BOUNDARY/ROAD MARKINGS
- MORGAN AND MORECAMBE ORDER LIMITS
- ▨ PROPOSED EXTENTS OF JUNCTION WIDENING

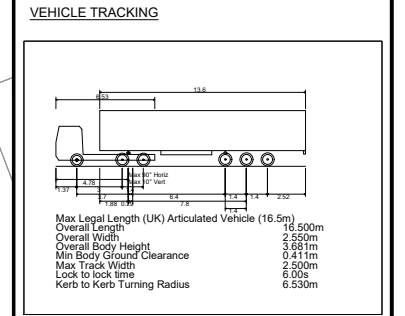

- ▨ VEHICLE BODY SWEEP PATH (FORWARD GEAR)
- VEHICLE CHASSIS SWEEP PATH

REV	DATE	DESCRIPTION	BY	CHK	APP
P01	15.01.24	FIRST ISSUE	AA	SKT	SKT

REVISIONS

CLIENT

MORECAMBE OFFSHORE WIND FARM LTD AND MORGAN OFFSHORE WINDFARM LTD

PROJECT  
MORGAN AND MORECAMBE OFFSHORE WIND FARMS TRANSMISSION ASSETS

TITLE  
ACCESS A59 SWEEP PATH ANALYSIS



DRAWN	CHECKED	APPROVED
AA	SKT	SKT
DATE	SCALE	AUTOCAD REF.
15.01.24	AT A3 1:500	
DRAWING No.	PC1165-RHD-ZZ-XX-SW-TP-0135	REVISION
CLIENT DWG No.		P01

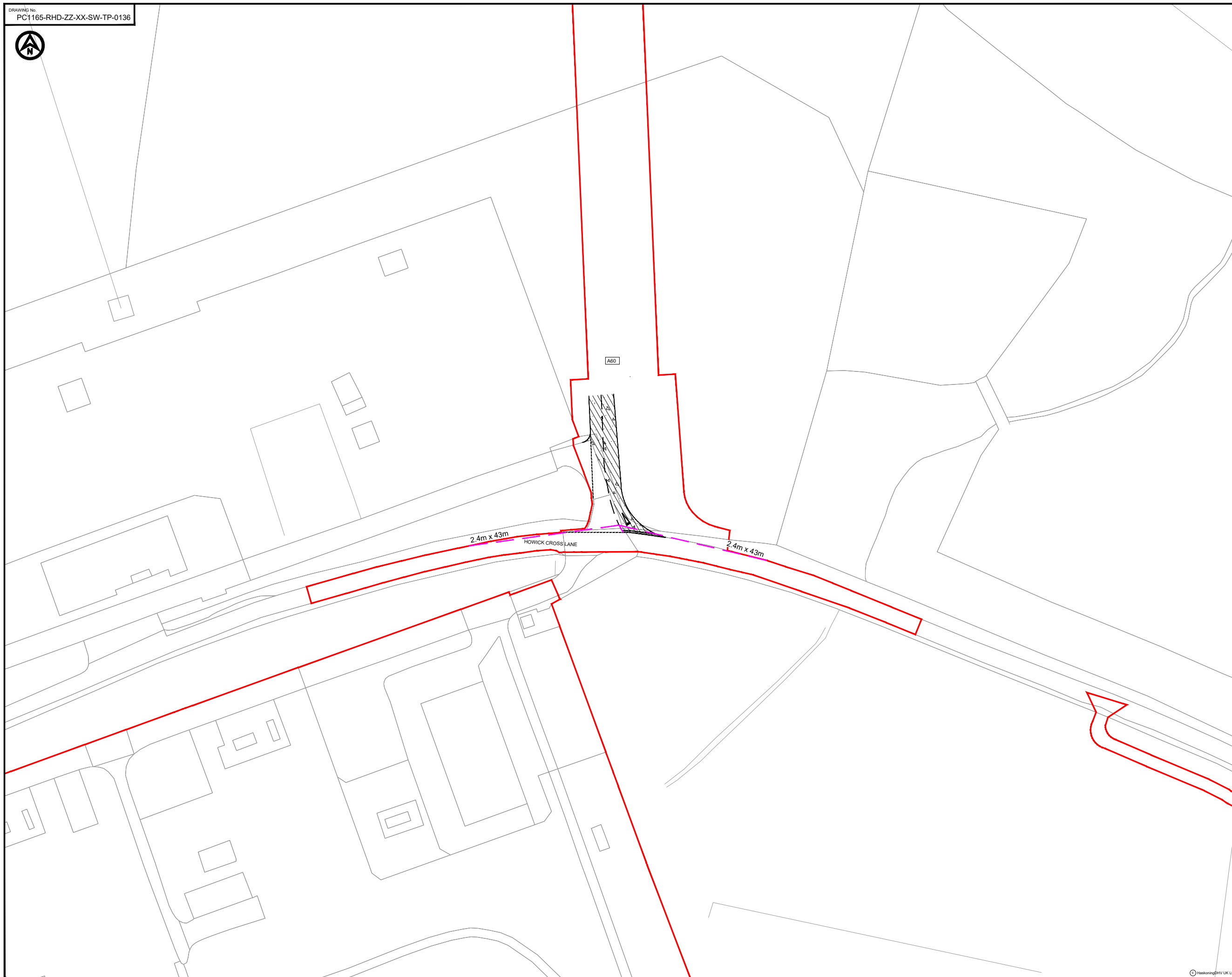

- NOTES**
1. Do not scale from this drawing, all dimensions are in metres unless noted otherwise.
  2. This drawing has been based upon Ordnance Survey Maps and Royal HaskoningDHV can not guarantee the accuracy of data.
  3. X-distance - the set back from the nearest edge of the carriageway from which the access will be taken
  4. Y-Distance - the SSD measured along the nearest edge of the carriageway to its intersection with the centreline of the access.
  5. All vegetation to be cleared/trimmed within identified visibility envelope and thereafter maintained in accordance with Local Highway Authority maintenance practices.
  6. Requirement for diverge tapers to be determined once daily flows into access established.

**KEY**

- EXISTING ARRANGEMENT
- PROPOSED ACCESS BOUNDARY/ROAD MARKINGS
- VISIBILITY SPLAY FOR ASSUMED JUNCTION LOCATION
- MORGAN AND MORECAMBE ORDER LIMITS
- ▨ FULL DEPTH CARRIAGEWAY CONSTRUCTION WITH BOUND SURFACE
- ▨ PROPOSED EXTENTS OF JUNCTION WIDENING

P02	03.05.24	UPDATED WORK AREA AND ORDER LIMITS	AA	SKT	SKT
P01	15.01.23	FIRST ISSUE	AA	SKT	SKT
REV	DATE	DESCRIPTION	BY	CHK	APP

REVISIONS

CLIENT

**MORECAMBE OFFSHORE WIND FARM LTD AND MORGAN OFFSHORE WINDFARM LTD**

**PROJECT**  
MORGAN AND MORECAMBE OFFSHORE WIND FARMS TRANSMISSION ASSETS

**TITLE**  
ACCESS A60  
GENERAL ARRANGEMENT



DRAWN	AA	CHECKED	SKT	APPROVED	SKT
DATE	15.01.24	SCALE AT AS	1:1000	AUTOCAD REF.	
DRAWING No.	PC1165-RHD-ZZ-XX-SW-TP-0136			REVISION	
CLIENT DWG No.					P02

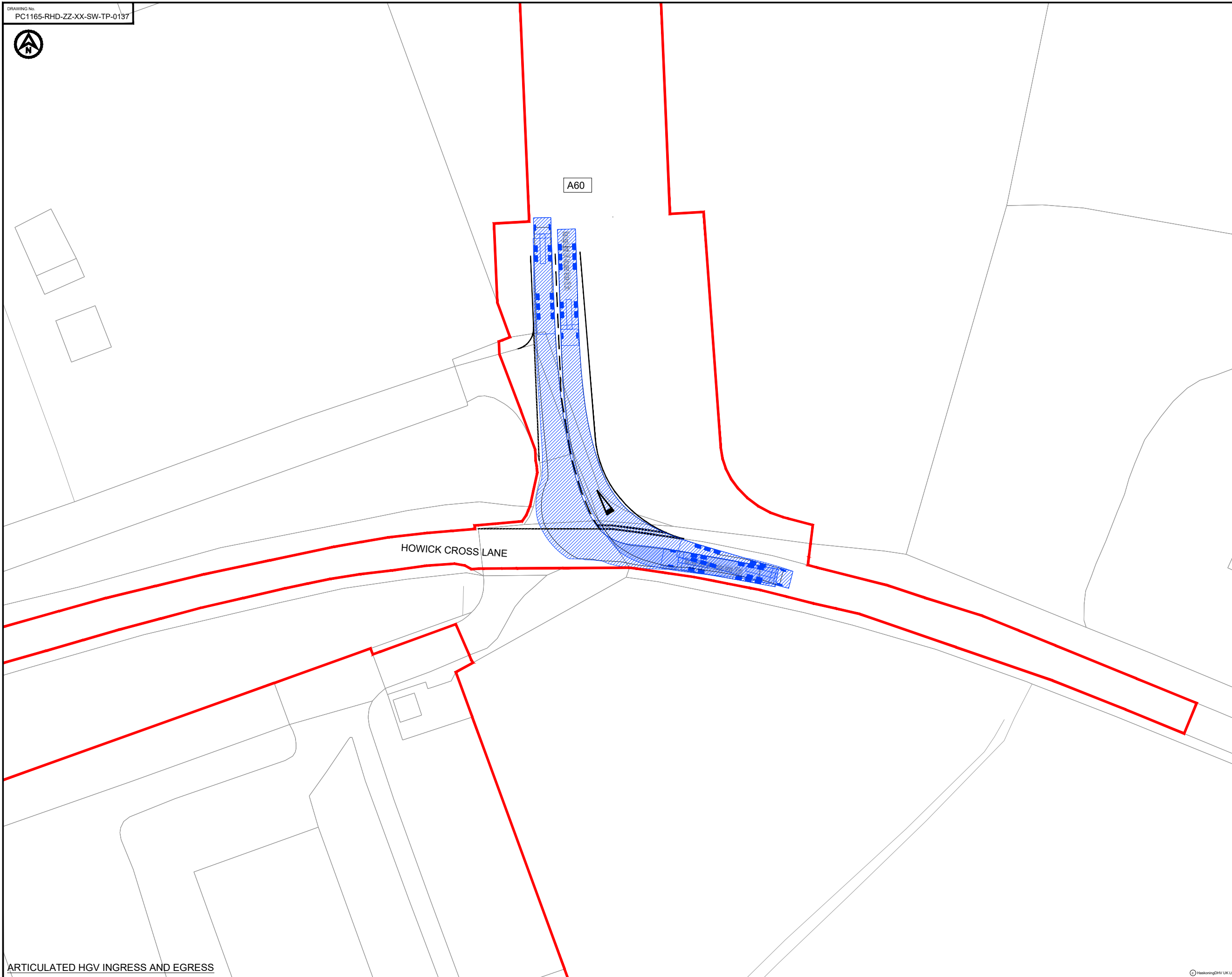

ARTICULATED HGV INGRESS AND EGRESS

- NOTES**
1. Do not scale from this drawing, all dimensions are in metres unless noted otherwise.
  2. This drawing has been based upon Ordnance Survey Maps and Royal HaskoningDHV can not guarantee the accuracy of data.
  3. X-distance - the set back from the nearest edge of the carriageway from which the access will be taken
  4. Y-Distance - the SSD measured along the nearest edge of the carriageway to its intersection with the centreline of the access.
  5. All vegetation to be cleared/trimmed within identified visibility envelope and thereafter maintained in accordance with Local Highway Authority maintenance practices.
  6. Requirement for diverge tapers to be determined once daily flows into access established.

**KEY**

	EXISTING ARRANGEMENT
	PROPOSED ACCESS BOUNDARY/ROAD MARKINGS
	MORGAN AND MORECAMBE ORDER LIMITS

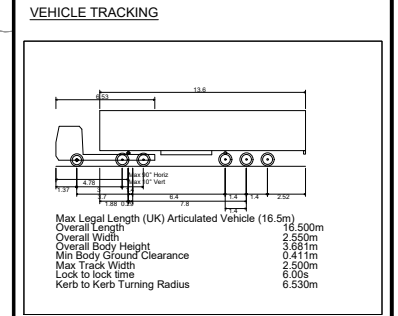

	VEHICLE BODY SWEEP PATH (FORWARD GEAR)
	VEHICLE CHASSIS SWEEP PATH

REV	DATE	DESCRIPTION	BY	CHK	APP
P01	15.01.24	FIRST ISSUE	AA	SKT	SKT

REVISIONS

CLIENT

**MORECAMBE OFFSHORE WIND FARM LTD AND MORGAN OFFSHORE WINDFARM LTD**

PROJECT

**MORGAN AND MORECAMBE OFFSHORE WIND FARMS TRANSMISSION ASSETS**

TITLE

**ACCESS A60 SWEEP PATH ANALYSIS**



DRAWN	AA	CHECKED	SKT	APPROVED	SKT
DATE	15.01.24	SCALE AT A3	1:500	AUTOCAD REF.	
DRAWING No.	PC1165-RHD-ZZ-XX-SW-TP-0137			REVISION	
CLIENT DWG No.				REVISION	P01

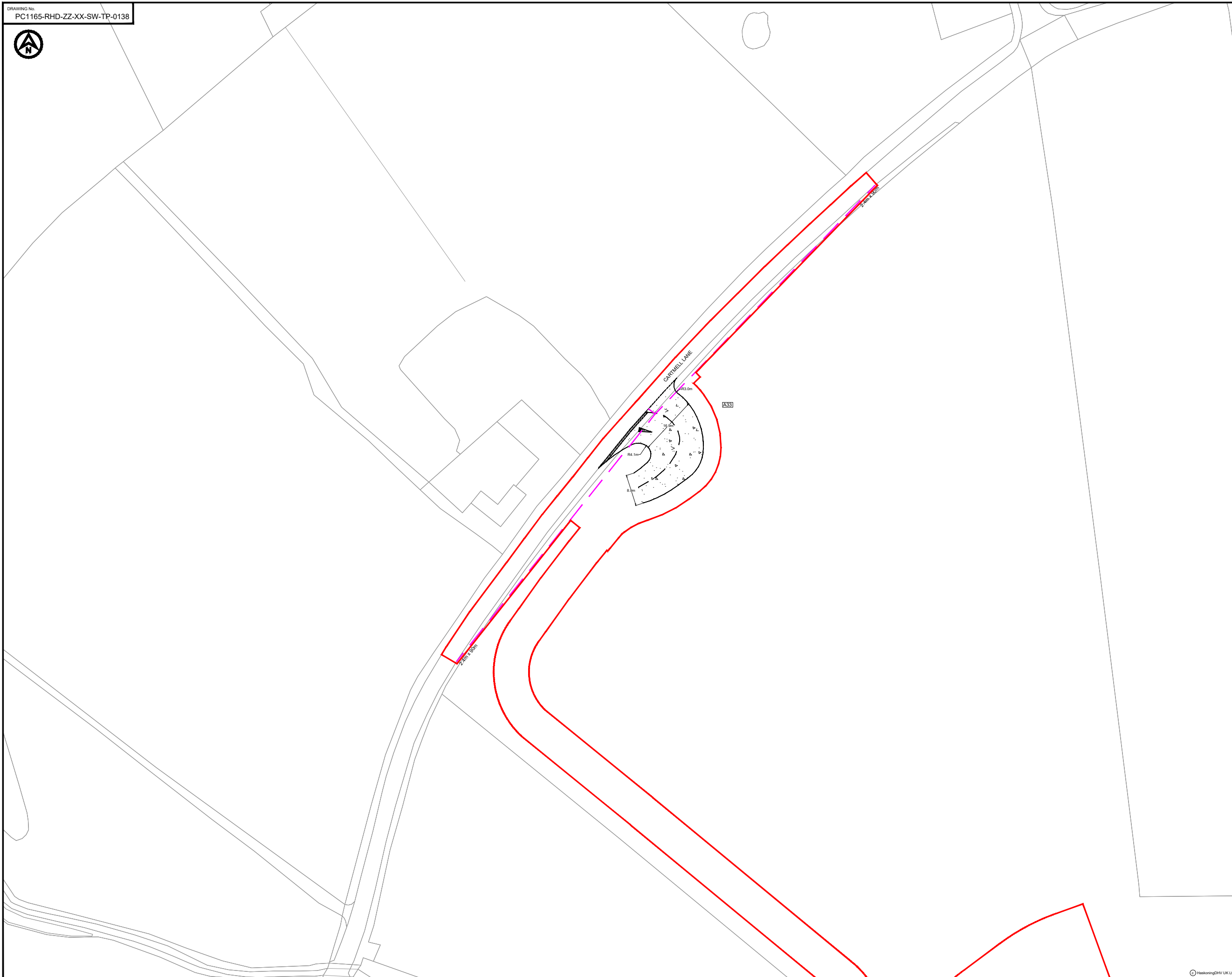

- NOTES**
1. Do not scale from this drawing, all dimensions are in metres unless noted otherwise.
  2. This drawing has been based upon Ordnance Survey Maps and Royal HaskoningDHV can not guarantee the accuracy of data.
  3. X-distance - the set back from the nearest edge of the carriageway from which the access will be taken
  4. Y-Distance - the SSD measured along the nearest edge of the carriageway to its intersection with the centreline of the access.
  5. All vegetation to be cleared/trimmed within identified visibility envelope and thereafter maintained in accordance with Local Highway Authority maintenance practices.
  6. Requirement for diverge tapers to be determined once daily flows into access established.

**KEY**

- EXISTING ARRANGEMENT
- PROPOSED ACCESS BOUNDARY/ROAD MARKINGS
- VISIBILITY SPLAY FOR ASSUMED JUNCTION LOCATION
- MORGAN AND MORECAMBE ORDER LIMITS
- FULL DEPTH CARRIAGEWAY CONSTRUCTION WITH BOUND SURFACE

REV	DATE	DESCRIPTION	BY	CHK	APP
P02	01.05.24	UPDATED WORK AREA AND ORDER LIMITS	AA	SKT	SKT
P01	15.01.23	FIRST ISSUE	AA	SKT	SKT

REVISIONS

CLIENT

**MORECAMBE OFFSHORE WIND FARM LTD AND MORGAN OFFSHORE WINDFARM LTD**

PROJECT

**MORGAN AND MORECAMBE OFFSHORE WIND FARMS TRANSMISSION ASSETS**

TITLE

**ACCESS A33  
GENERAL ARRANGEMENT**



DRAWN	CHECKED	APPROVED
AA	SKT	SKT

DATE: 15.01.24 SCALE AT A3: 1:1000 AUTOCAD REF:

DRAWING No: PC1165-RHD-ZZ-XX-SW-TP-0138 REVISION: P02

CLIENT DWG No: P02

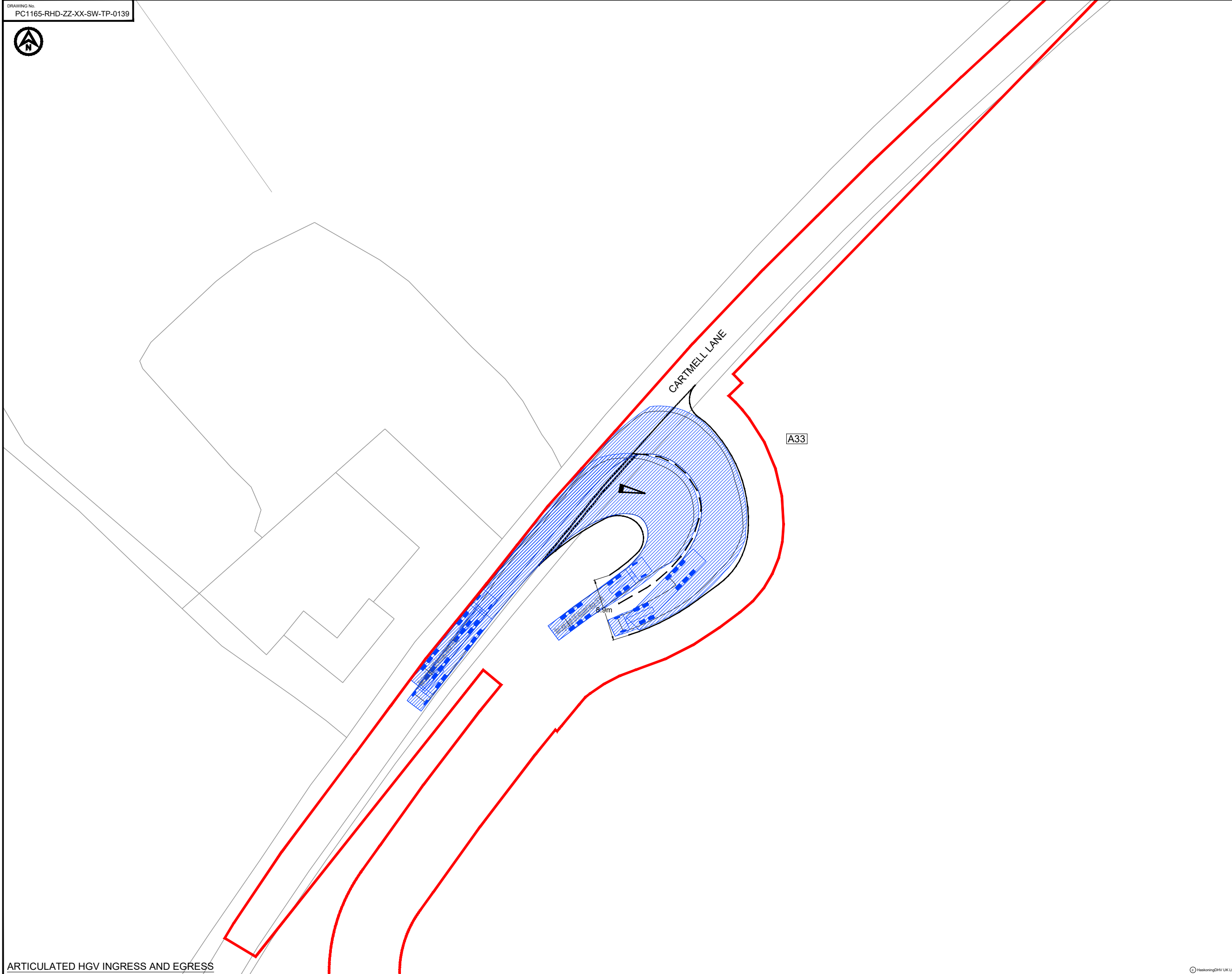

- NOTES**
1. Do not scale from this drawing, all dimensions are in metres unless noted otherwise.
  2. This drawing has been based upon Ordnance Survey Maps and Royal HaskoningDHV can not guarantee the accuracy of data.
  3. X-distance - the set back from the nearest edge of the carriageway from which the access will be taken
  4. Y-Distance - the SSD measured along the nearest edge of the carriageway to its intersection with the centreline of the access.
  5. All vegetation to be cleared/trimmed within identified visibility envelope and thereafter maintained in accordance with Local Highway Authority maintenance practices.
  6. Requirement for diverge tapers to be determined once daily flows into access established.

**KEY**

	EXISTING ARRANGEMENT
	PROPOSED ACCESS BOUNDARY/ROAD MARKINGS
	MORGAN AND MORECAMBE ORDER LIMITS

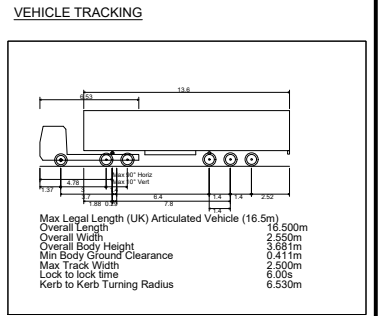

	VEHICLE BODY SWEEP PATH (FORWARD GEAR)
	VEHICLE CHASSIS SWEEP PATH

REV	DATE	DESCRIPTION	BY	CHK	APP
P01	15.01.24	FIRST ISSUE	AA	SKT	SKT

REVISIONS

CLIENT

**MORECAMBE OFFSHORE WIND FARM LTD AND MORGAN OFFSHORE WINDFARM LTD**

PROJECT

**MORGAN AND MORECAMBE OFFSHORE WIND FARMS TRANSMISSION ASSETS**

TITLE

**ACCESS A33 SWEEP PATH ANALYSIS**



DRAWN	AA	CHECKED	SKT	APPROVED	SKT
DATE	15.01.24	SCALE AT A3	1:500	AUTOCAD REF.	
DRAWING No.	PC1165-RHD-ZZ-XX-SW-TP-0139			REVISION	
CLIENT DWG No.					P01





- NOTES**
- Do not scale from this drawing, all dimensions are in metres unless noted otherwise.
  - This drawing has been based upon Ordnance Survey Maps and Royal HaskoningDHV can not guarantee the accuracy of data.
  - X-distance - the set back from the nearest edge of the carriageway from which the access will be taken
  - Y-Distance - the SSD measured along the nearest edge of the carriageway to its intersection with the centreline of the access.
  - All vegetation to be cleared/trimmed within identified visibility envelope and thereafter maintained in accordance with Local Highway Authority maintenance practices.
  - Requirement for diverge tapers to be determined once daily flows into access established.

**KEY**

- EXISTING ARRANGEMENT
- PROPOSED ACCESS BOUNDARY/ROAD MARKINGS
- - - VISIBILITY SPLAY FOR ASSUMED JUNCTION LOCATION
- MORGAN AND MORECAMBE ORDER LIMITS
- FULL DEPTH CARRIAGEWAY CONSTRUCTION WITH BOUND SURFACE

REV	DATE	DESCRIPTION	BY	CHK	APP
P02	03.05.24	UPDATED WORK AREA AND ORDER LIMITS	AA	SKT	SKT
P01	17.01.23	FIRST ISSUE	AA	SKT	SKT

REVISIONS

CLIENT

**MORECAMBE OFFSHORE WIND FARM LTD AND MORGAN OFFSHORE WINDFARM LTD**

**PROJECT**  
MORGAN AND MORECAMBE OFFSHORE WIND FARMS TRANSMISSION ASSETS

**TITLE**  
ACCESS A02  
GENERAL ARRANGEMENT



DRAWN	CHECKED	APPROVED
AA	SKT	SKT

DATE: 17.01.24 SCALE AT A3: 1:1000 AUTOCAD REF:  
DRAWING No: PC1165-RHD-ZZ-XX-SW-TP-0142 REVISION:  
CLIENT DWG No: P02

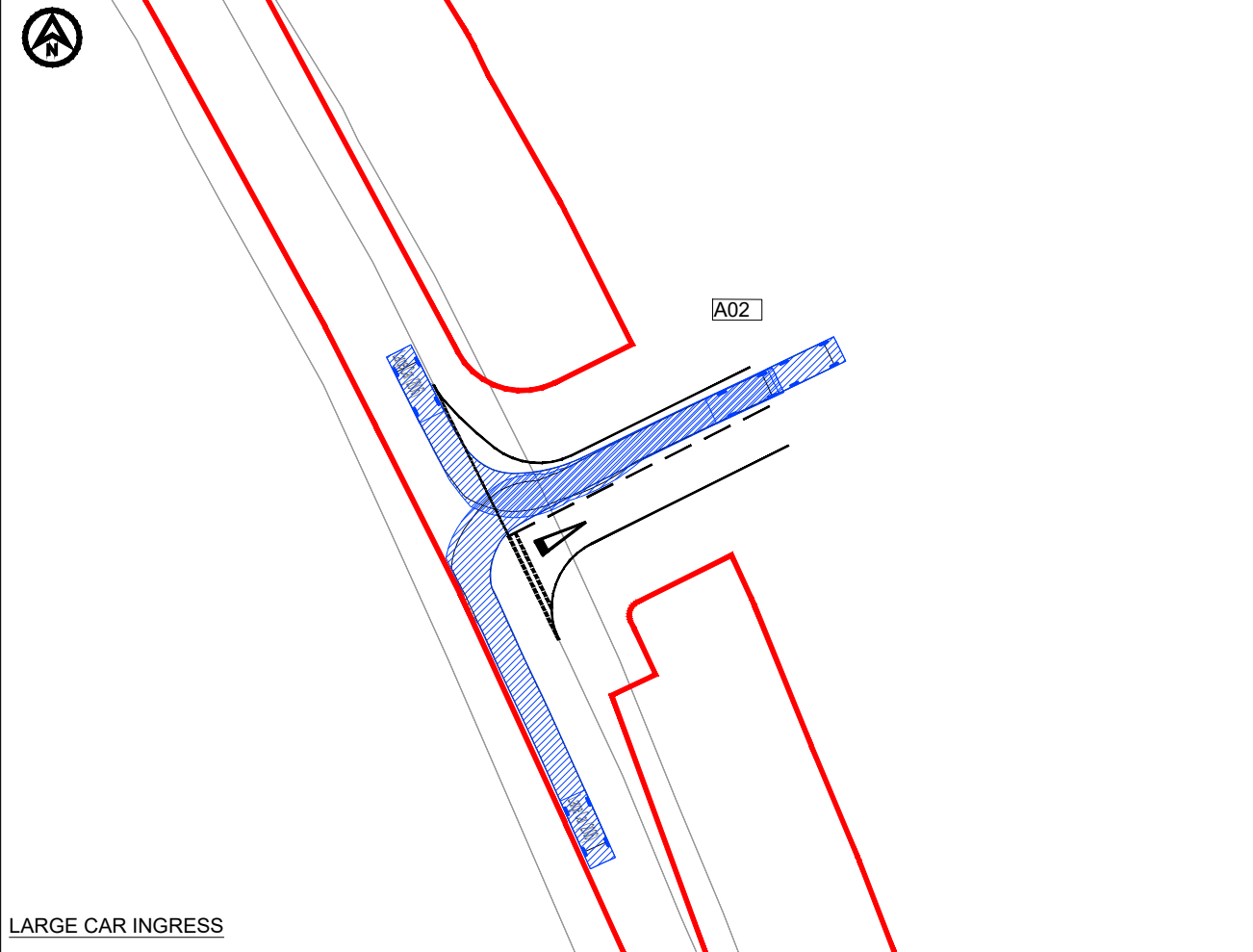

LARGE CAR INGRESS

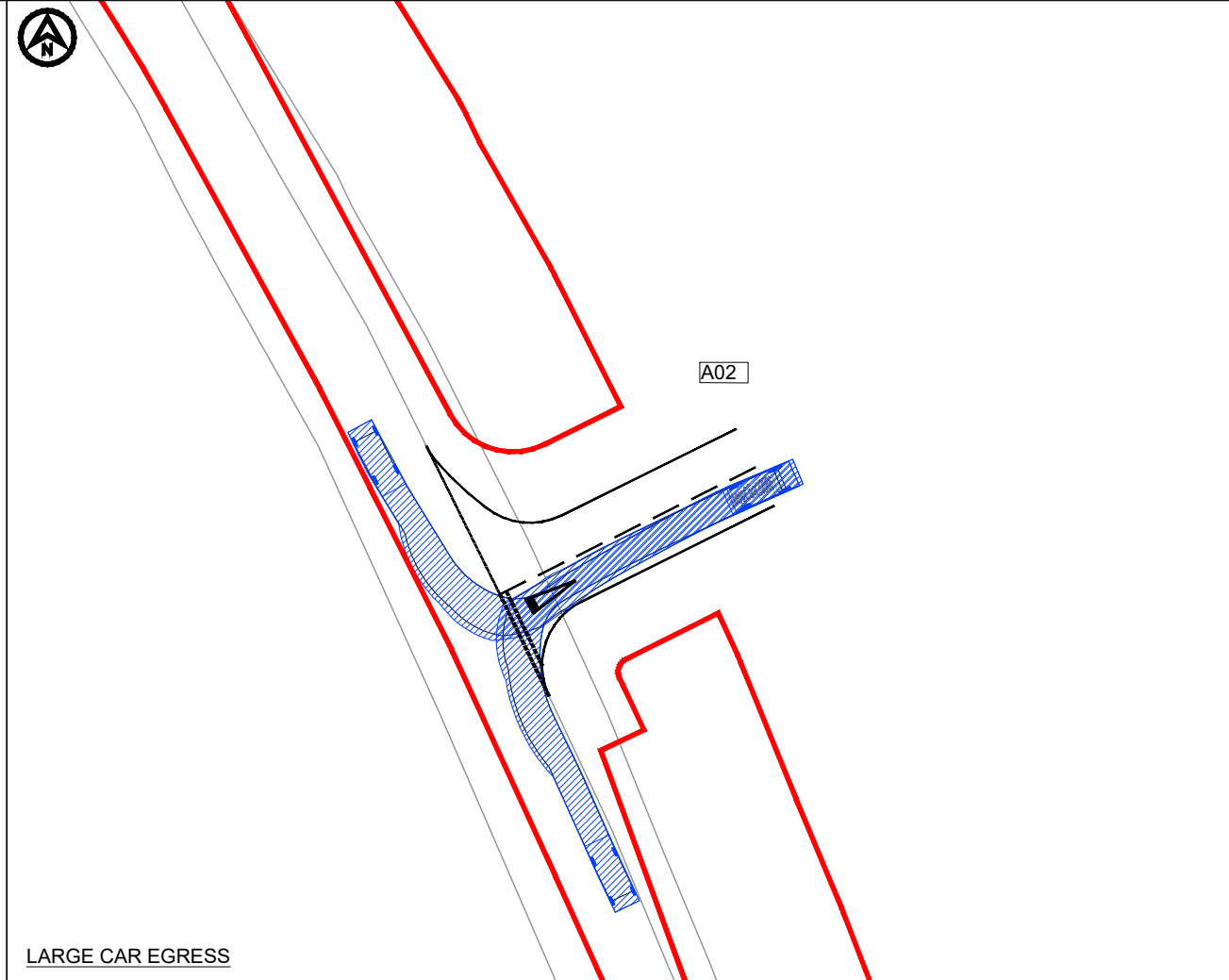

LARGE CAR EGRESS

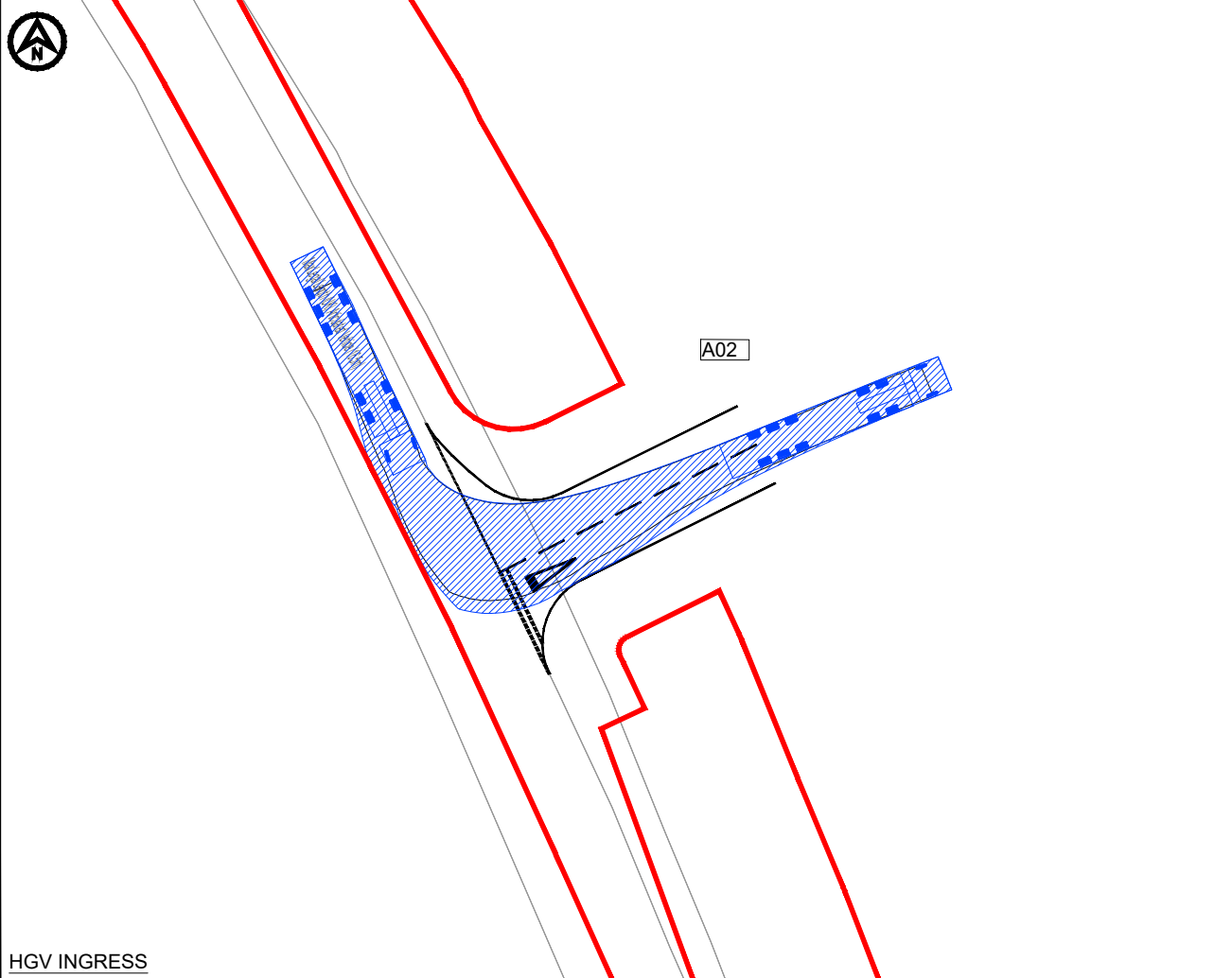

HGV INGRESS

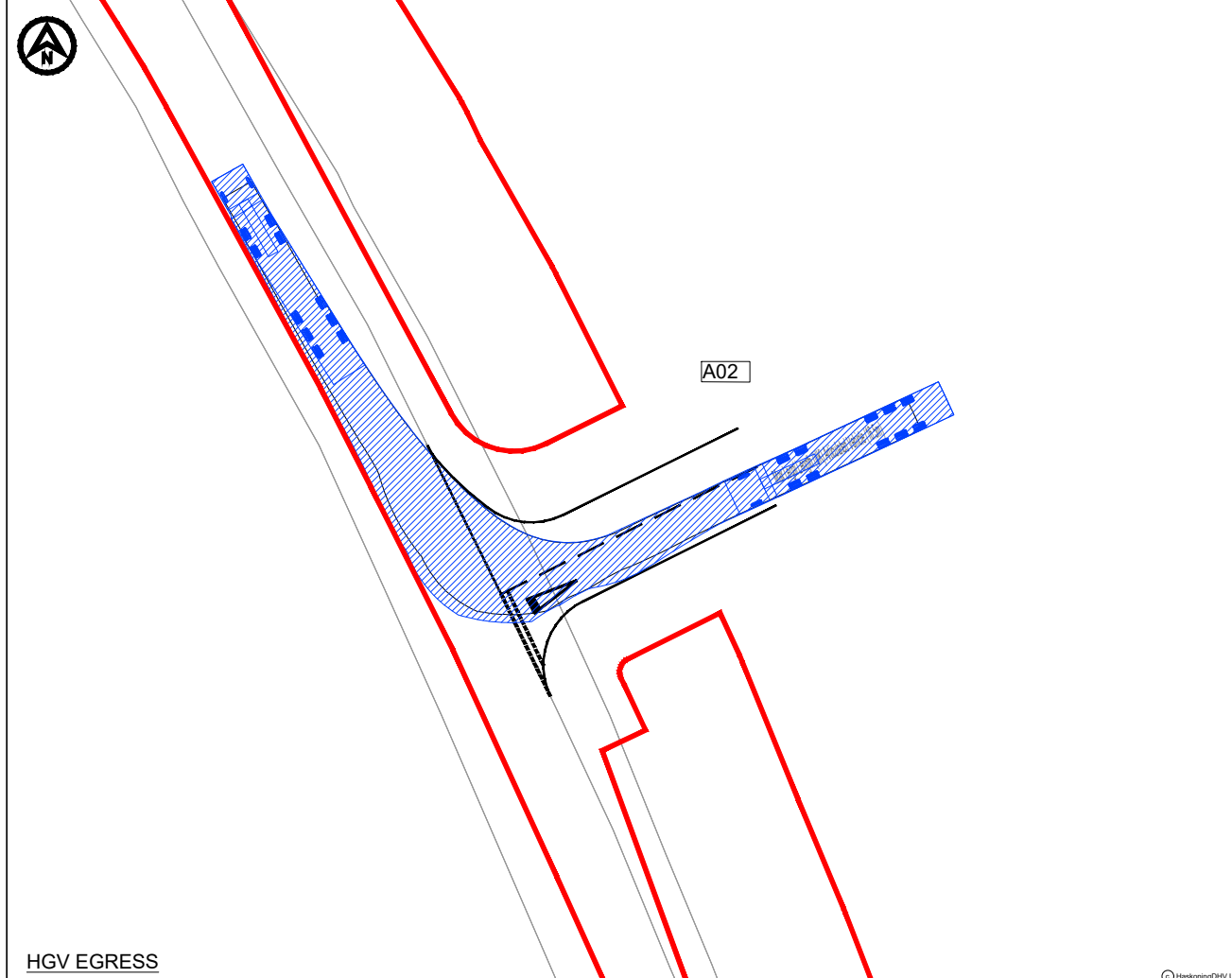

HGV EGRESS

- NOTES**
1. Do not scale from this drawing, all dimensions are in metres unless noted otherwise.
  2. This drawing has been based upon Ordnance Survey Maps and Royal HaskoningDHV can not guarantee the accuracy of data.
  3. X-Distance - the set back from the nearest edge of the access.
  4. Y-Distance - the SSD measured along the nearest edge of the carriageway to its intersection with the centreline of the access.
  5. All vegetation to be cleared/trimmed within identified visibility envelope and thereafter maintained in accordance with Local Highway Authority maintenance practices.
  6. Requirement for diverge tapers to be determined once daily flows into access established.

**KEY**

- EXISTING ARRANGEMENT
- PROPOSED ACCESS BOUNDARY/ROAD MARKINGS
- MORGAN AND MORECAMBE ORDER LIMITS

**VEHICLE TRACKING**

Large Car (2006)	5.079m
Overall Length	1.972m
Overall Width	1.525m
Overall Body Height	0.310m
Min Body Ground Clearance	1.931m
Max Track Width	4.00s
Lock to lock time	5.900m
Kerb to Kerb Turning Radius	

Max Legal Length (UK) Articulated Vehicle (16.5m)	16.500m
Overall Length	2.550m
Overall Width	3.381m
Overall Body Height	0.411m
Min Body Ground Clearance	2.500m
Max Track Width	6.00s
Lock to lock time	6.530m
Kerb to Kerb Turning Radius	

- VEHICLE BODY SWEEP PATH (FORWARD GEAR)
- VEHICLE CHASSIS SWEEP PATH

REV	DATE	DESCRIPTION	BY	CHK	APP
P01	17.01.24	FIRST ISSUE	AA	SKT	SKT

REVISIONS

CLIENT

MORECAMBE OFFSHORE WIND FARM LTD AND MORGAN OFFSHORE WINDFARM LTD

PROJECT  
MORGAN AND MORECAMBE OFFSHORE WIND FARMS TRANSMISSION ASSETS

TITLE  
ACCESS A02 SWEEP PATH ANALYSIS



DRAWN	AA	CHECKED	SKT	APPROVED	SKT
DATE	17.01.24	SCALE AT A3	1:500	AUTOCAD REF.	
DRAWING No.	PC1165-RHD-ZZ-XX-SW-TP-0143			REVISION	
CLIENT DWG No.				REVISION	P01



- NOTES**
1. Do not scale from this drawing, all dimensions are in metres unless noted otherwise.
  2. This drawing has been based upon Ordnance Survey Maps and Royal HaskoningDHV can not guarantee the accuracy of data.
  3. X-distance - the set back from the nearest edge of the carriageway from which the access will be taken
  4. Y-Distance - the SSD measured along the nearest edge of the carriageway to its intersection with the centreline of the access.
  5. All vegetation to be cleared/trimmed within identified visibility envelope and thereafter maintained in accordance with Local Highway Authority maintenance practices.

**KEY**

- EXISTING ARRANGEMENT
- PROPOSED ACCESS BOUNDARY/ROAD MARKINGS
- INDICATIVE ACCESS TRACK
- MORGAN AND MORECAMBE ORDER LIMITS
- VISIBILITY SPLAY FOR ASSUMED JUNCTION LOCATION
- BARRIERS SET 1m FROM THE EDGE OF THE PROPOSED ACCESS
- FULL DEPTH CARRIAGEWAY CONSTRUCTION WITH BOUND SURFACE
- VEGETATION REMOVAL AREA = 135 sq m (APPROX)
- EXISTING FOOTPATH
- PROPOSED FOOTPATH AREA TO BE CLOSED

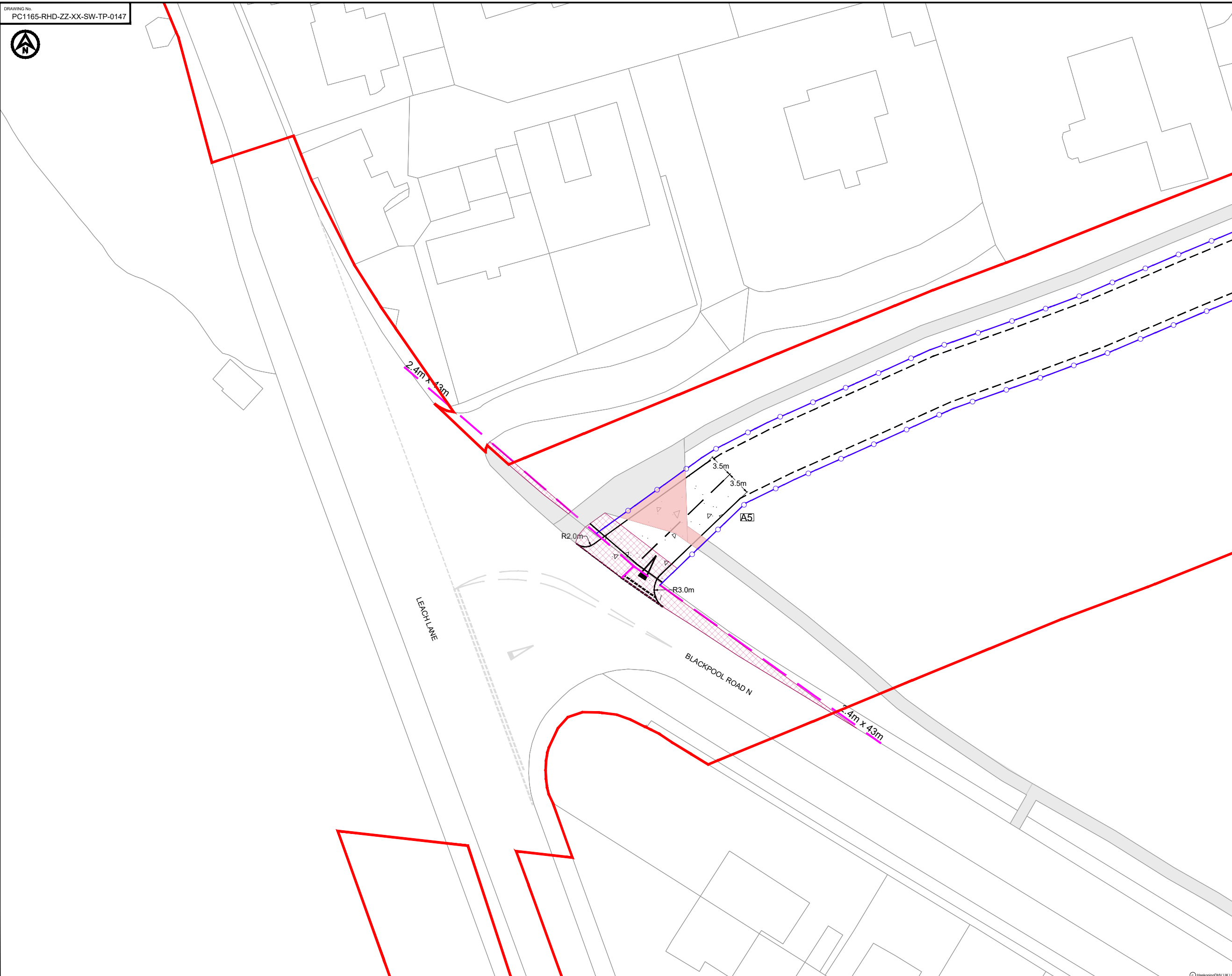

REV	DATE	DESCRIPTION	BY	CHK	APP
P02	30.04.24	UPDATED WORK AREA AND ORDER LIMITS	AA	SKT	SKT
P01	04.04.24	FIRST ISSUE	AA	SKT	SKT

REVISIONS

CLIENT

MORECAMBE OFFSHORE WIND FARM LTD AND MORGAN OFFSHORE WINDFARM LTD

PROJECT  
MORGAN AND MORECAMBE OFFSHORE WIND FARMS TRANSMISSION ASSETS

TITLE  
ACCESS A5  
GENERAL ARRANGEMENT



DRAWN	CHECKED	APPROVED
AA	SKT	SKT
DATE	SCALE AT A3	AUTOCAD REF.
04.04.24	1:500	
DRAWING No.	PC1165-RHD-ZZ-XX-SW-TP-0147	REVISION
CLIENT DWG No.		P01



**NOTES**  
 1. Do not scale from this drawing, all dimensions are in metres unless noted otherwise.  
 2. This drawing has been based upon Ordnance Survey Maps and Royal HaskoningDHV can not guarantee the accuracy of data.

**KEY**

- EXISTING ARRANGEMENT
- PROPOSED ACCESS BOUNDARY/ROAD MARKINGS
- MORGAN AND MORECAMBE ORDER LIMITS

**VEHICLE TRACKING**

Max Legal Length (UK) Articulated Vehicle (16.5m)  
 Overall Length 16.500m  
 Overall Width 2.550m  
 Overall Body Height 3.681m  
 Min Body Ground Clearance 0.411m  
 Max Track Width 2.500m  
 Lock to lock time 6.00s  
 Kerb to Kerb Turning Radius 6.530m

▨ VEHICLE BODY SWEPT PATH (FORWARD GEAR)  
 — VEHICLE CHASSIS SWEPT PATH

REV	DATE	DESCRIPTION	BY	CHK	APP
P01	04.04.24	FIRST ISSUE	AA	SKT	SKT

REVISIONS

CLIENT

**MORECAMBE OFFSHORE WIND FARM LTD AND MORGAN OFFSHORE WINDFARM LTD**

PROJECT

**MORGAN AND MORECAMBE OFFSHORE WIND FARMS TRANSMISSION ASSETS**

TITLE

**ACCESS A5 SWEPT PATH ANALYSIS**



DRAWN	AA	CHECKED	SKT	APPROVED	SKT
DATE	04.04.2024	SCALE AT A3	1:500	AUTOCAD REF.	
DRAWING No.	PC1165-RHD-ZZ-XX-SW-TP-0148			REVISION	
CLIENT DWG No.					P01



- NOTES**
1. Do not scale from this drawing, all dimensions are in metres unless noted otherwise.
  2. This drawing has been based upon Ordnance Survey Maps and Royal HaskoningDHV can not guarantee the accuracy of data.
  3. X-distance - the set back from the nearest edge of the carriageway from which the access will be taken
  4. Y-Distance - the SSD measured along the nearest edge of the carriageway to its intersection with the centreline of the access.
  5. All vegetation to be cleared/trimmed within identified visibility envelope and thereafter maintained in accordance with Local Highway Authority maintenance practices.

**KEY**

- EXISTING ARRANGEMENT
- PROPOSED ACCESS BOUNDARY/ROAD MARKINGS
- MORGAN AND MORECAMBE ORDER LIMITS
- VISIBILITY SPLAY FOR ASSUMED JUNCTION LOCATION
- BARRIERS SET 1m FROM THE EDGE OF THE PROPOSED ACCESS
- EXISTING BOLLARD FENCE
- FULL DEPTH CARRIAGEWAY CONSTRUCTION WITH BOUND SURFACE
- PROPOSED NEW UNCONTROLLED TACTILE CROSS OVER

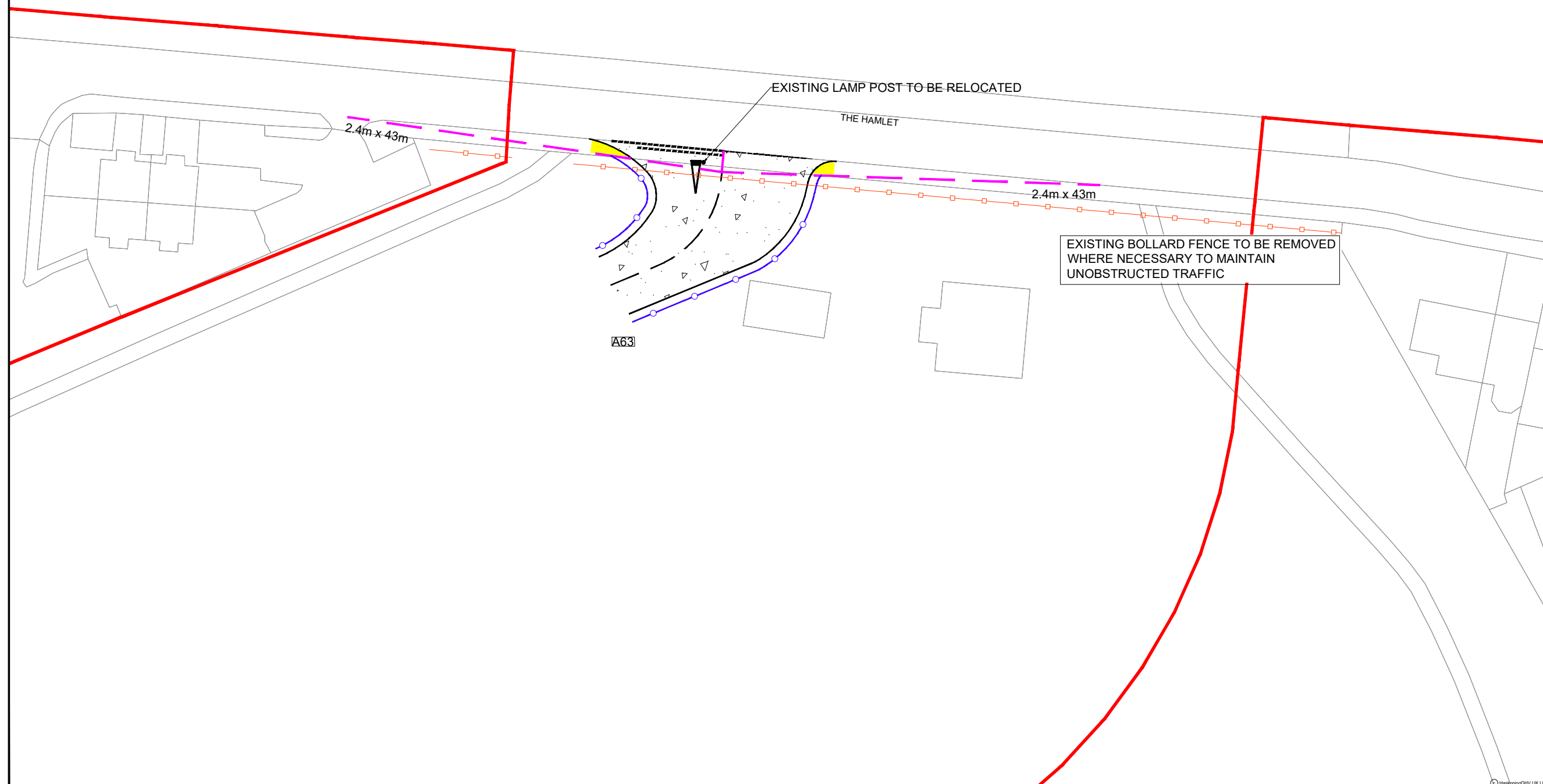

REV	DATE	DESCRIPTION	BY	CHK	APP
P01	04.09.24	FIRST ISSUE	AA	SKT	SKT

REVISIONS

CLIENT

MORECAMBE OFFSHORE WIND FARM LTD AND MORGAN OFFSHORE WINDFARM LTD

PROJECT  
MORGAN AND MORECAMBE OFFSHORE WIND FARMS TRANSMISSION ASSETS

TITLE  
ACCESS A63  
GENERAL ARRANGEMENT



DRAWN	CHECKED	APPROVED
AA	SKT	SKT
DATE	SCALE AT A3	AUTOCAD REF.
04.09.24	1:500	
DRAWING No.	PC1165-RHD-ZZ-XX-SW-TP-0152	REVISION
CLIENT DWG No.		P01



**NOTES**  
 1. Do not scale from this drawing, all dimensions are in metres unless noted otherwise.  
 2. This drawing has been based upon Ordnance Survey Maps and Royal HaskoningDHV can not guarantee the accuracy of data.

**KEY**

- EXISTING ARRANGEMENT
- PROPOSED ACCESS BOUNDARY/ROAD MARKINGS
- MORGAN AND MORECAMBE ORDER LIMITS

**VEHICLE TRACKING**

Max Legal Length (UK) Articulated Vehicle (16.5m)  
 Overall Length 2.550m  
 Overall Width 2.350m  
 Overall Body Height 3.881m  
 Min Body Ground Clearance 0.411m  
 Max Track Width 2.500m  
 Lock to lock time 6.00s  
 Kerb to Kerb Turning Radius 6.530m

- VEHICLE BODY SWEPT PATH (FORWARD GEAR)
- VEHICLE CHASSIS SWEPT PATH

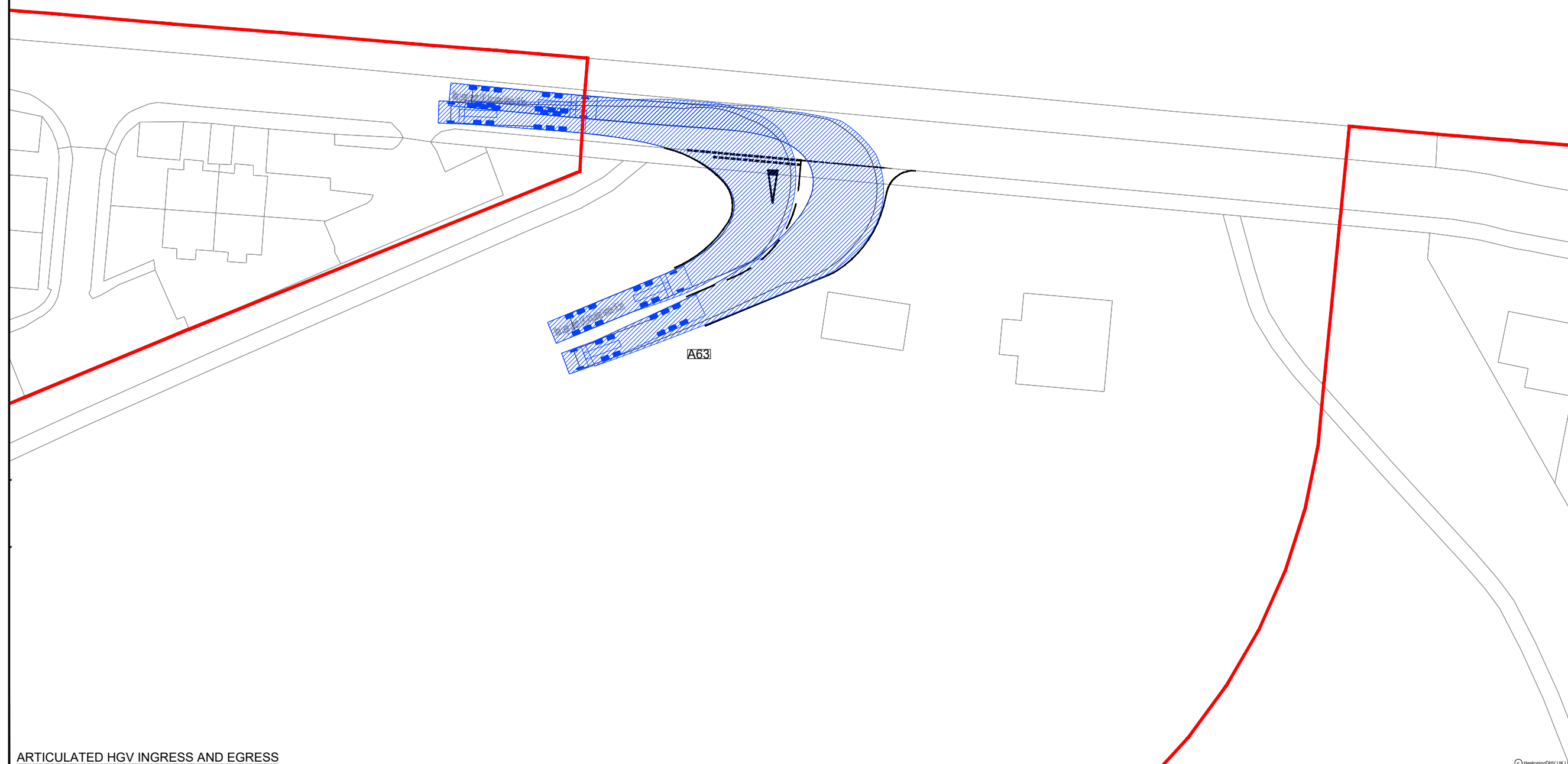

P01	04.09.24	FIRST ISSUE	AA	SKT	SKT
REV	DATE	DESCRIPTION	BY	CHK	APP

REVISIONS

CLIENT  
**MORECAMBE OFFSHORE WIND FARM LTD AND MORGAN OFFSHORE WINDFARM LTD**

PROJECT  
**MORGAN AND MORECAMBE OFFSHORE WIND FARMS TRANSMISSION ASSETS**

TITLE  
**ACCESS A63 SWEPT PATH ANALYSIS**



DRAWN	AA	CHECKED	SKT	APPROVED	SKT
DATE	04.09.24	SCALE AT A3	1:500	AUTOCAD REF.	
DRAWING No.	PC1165-RHD-ZZ-XX-SW-TP-0153			REVISION	
CLIENT DWG No.				REVISION	P01



**NOTES**

- Do not scale from this drawing; all dimensions are in metres unless noted otherwise.
- This drawing has been based upon Ordnance Survey Maps and Royal HaskoningDHV can not guarantee the accuracy of data.

**KEY**

- EXISTING ARRANGEMENT
- MORGAN AND MORECAMBE ORDER LIMITS
- - - VISIBILITY SPLAY FOR ASSUMED JUNCTION LOCATION

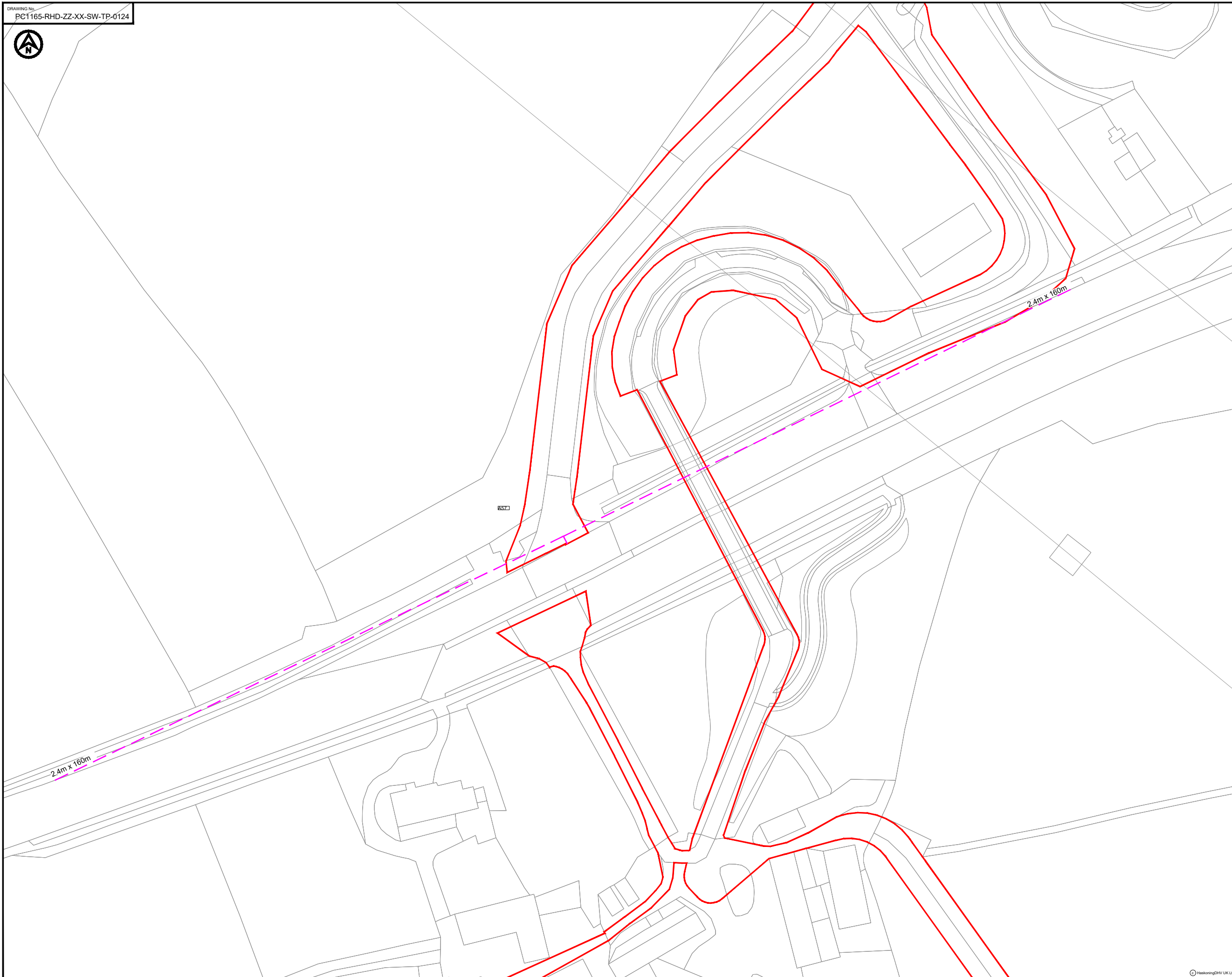

REV	DATE	DESCRIPTION	BY	CHK	APP
P01	13.12.23	FIRST ISSUE	AA	SKT	SKT

REVISIONS

CLIENT

**MORECAMBE OFFSHORE WIND FARM LTD AND MORGAN OFFSHORE WINDFARM LTD**

**PROJECT**  
MORGAN AND MORECAMBE OFFSHORE WIND FARMS TRANSMISSION ASSETS

**TITLE**  
ACCESS A57  
GENERAL ARRANGEMENT



DRAWN	CHECKED	APPROVED
AA	SKT	SKT
DATE	SCALE AT A3	AUTOCAD REF.
13.12.23	1:1000	
DRAWING No.	PC1165-RHD-ZZ-XX-SW-TP-0124	REVISION
CLIENT DWG No.		P01

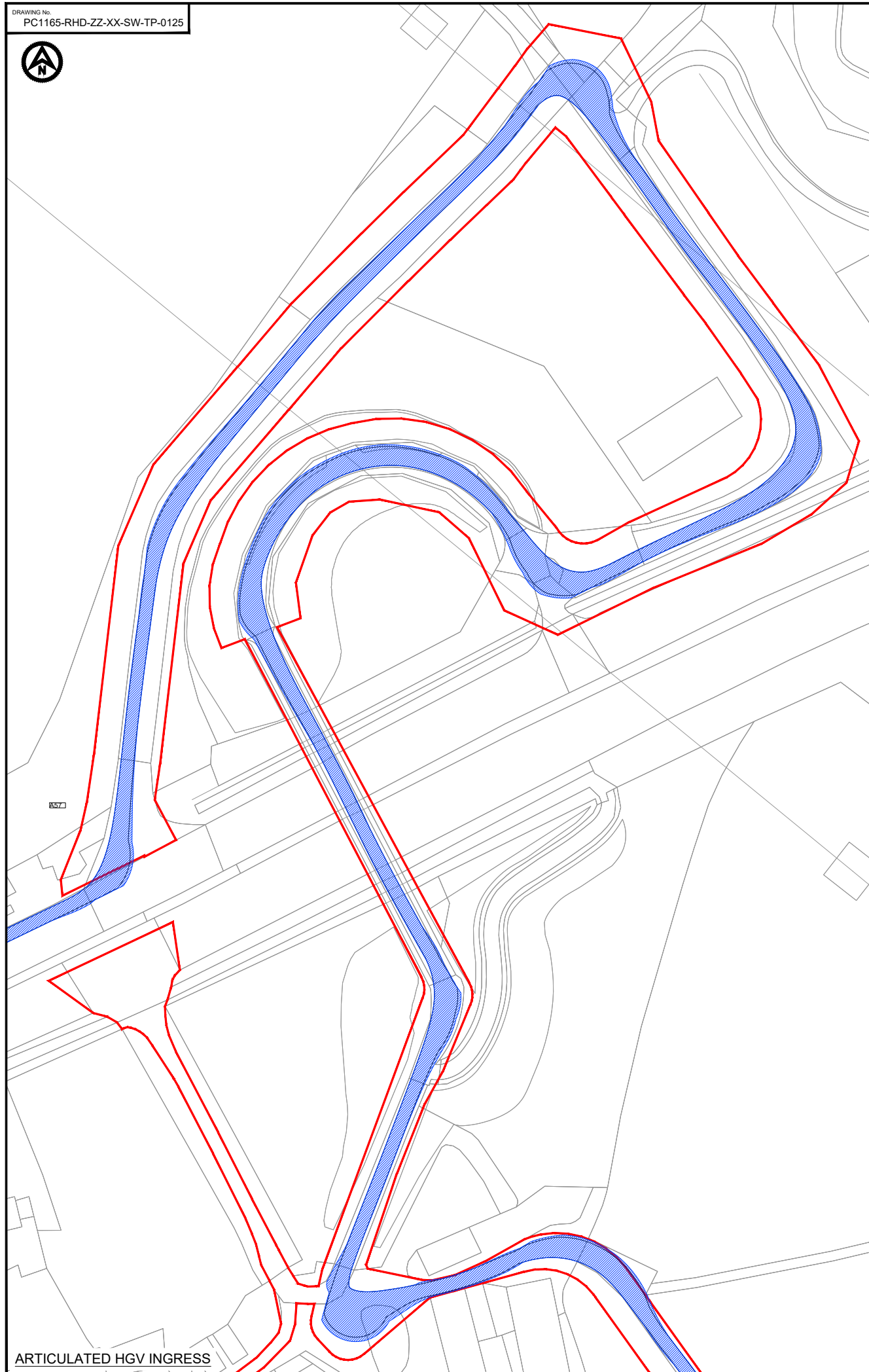

ARTICULATED HGV INGRESS

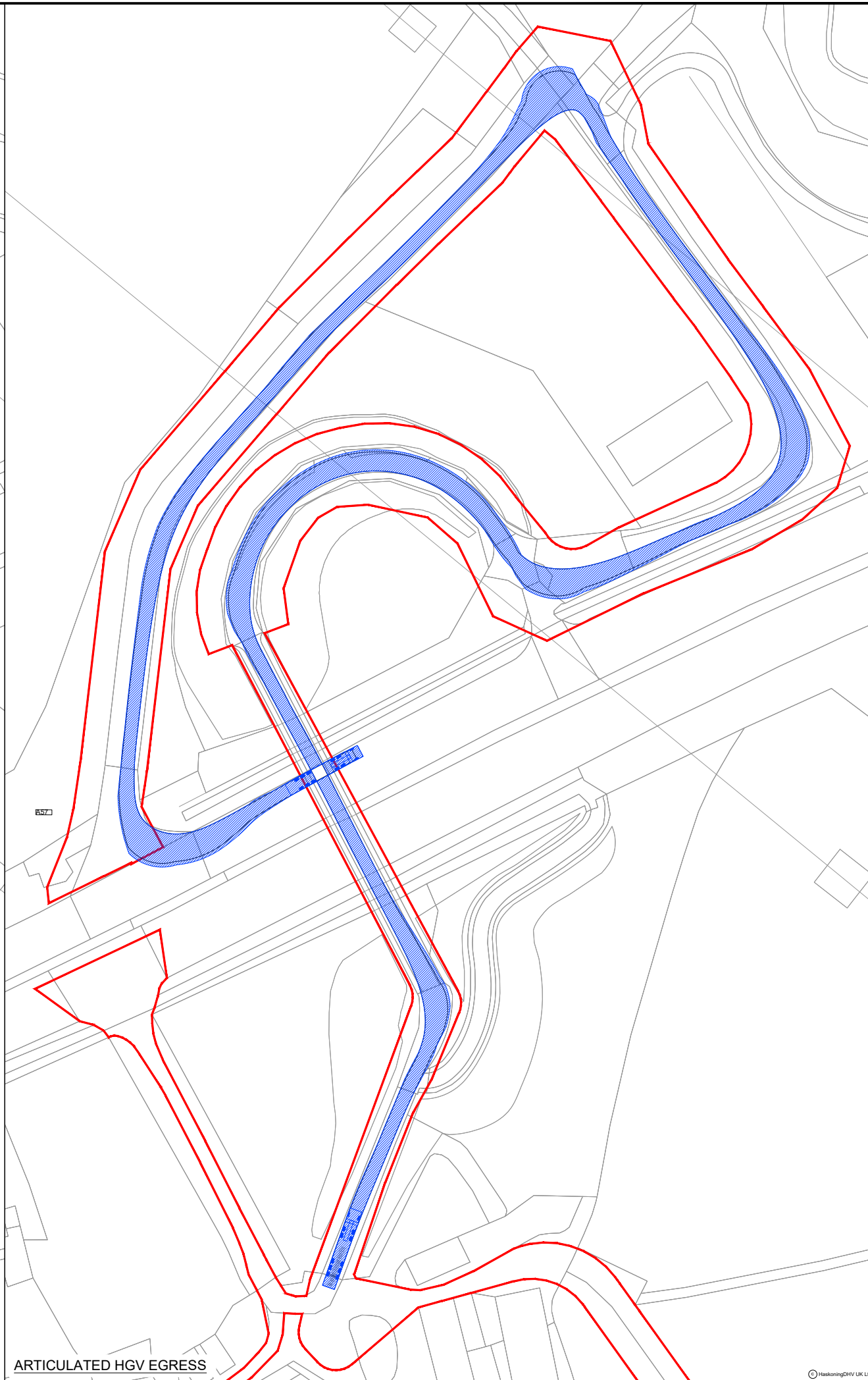

ARTICULATED HGV EGRESS

**NOTES**  
 1. Do not scale from this drawing; all dimensions are in metres unless noted otherwise.  
 2. This drawing has been based upon Ordnance Survey Maps and Royal HaskoningDHV can not guarantee the accuracy of data.

**KEY**

- EXISTING ARRANGEMENT
- MORGAN AND MORECAMBE ORDER LIMITS

**VEHICLE TRACKING**

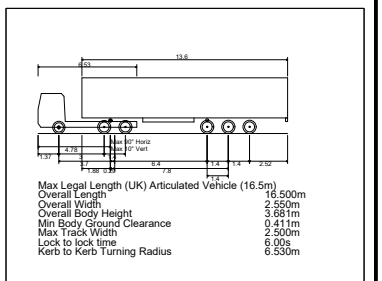

VEHICLE BODY SWEEP PATH (FORWARD GEAR)  
 VEHICLE CHASSIS SWEEP PATH

REV	DATE	DESCRIPTION	BY	CHK	APP
P01	13.12.23	FIRST ISSUE	AA	SKT	SKT

**REVISIONS**

**CLIENT**

MORECAMBE OFFSHORE WIND FARM LTD AND MORGAN OFFSHORE WINDFARM LTD

**PROJECT**  
MORGAN AND MORECAMBE OFFSHORE WIND FARMS TRANSMISSION ASSETS

**TITLE**

ACCESS A57  
SWEEP PATH ANALYSIS



DRAWN	CHECKED	APPROVED
AA	SKT	SKT
DATE	SCALE AT AS	AUTOCAD REF.
13.12.23	1:1000	
DRAWING No.	PC1165-RHD-ZZ-XX-SW-TP-0125	REVISION
CLIENT DWG No.		P01





- NOTES**
1. Do not scale from this drawing, all dimensions are in metres unless noted otherwise.
  2. This drawing has been based upon Ordnance Survey Maps and Royal HaskoningDHV can not guarantee the accuracy of data.
  3. X-distance - the set back from the nearest edge of the carriageway from which the access will be taken
  4. Y-Distance - the SSD measured along the nearest edge of the carriageway to its intersection with the centreline of the access.
  5. All vegetation to be cleared/trimmed within identified visibility envelope and thereafter maintained in accordance with Local Highway Authority maintenance practices.

**KEY**

	EXISTING ARRANGEMENT
	MORGAN AND MORECAMBE ORDER LIMITS
	VISIBILITY SPLAY FOR ASSUMED JUNCTION LOCATION

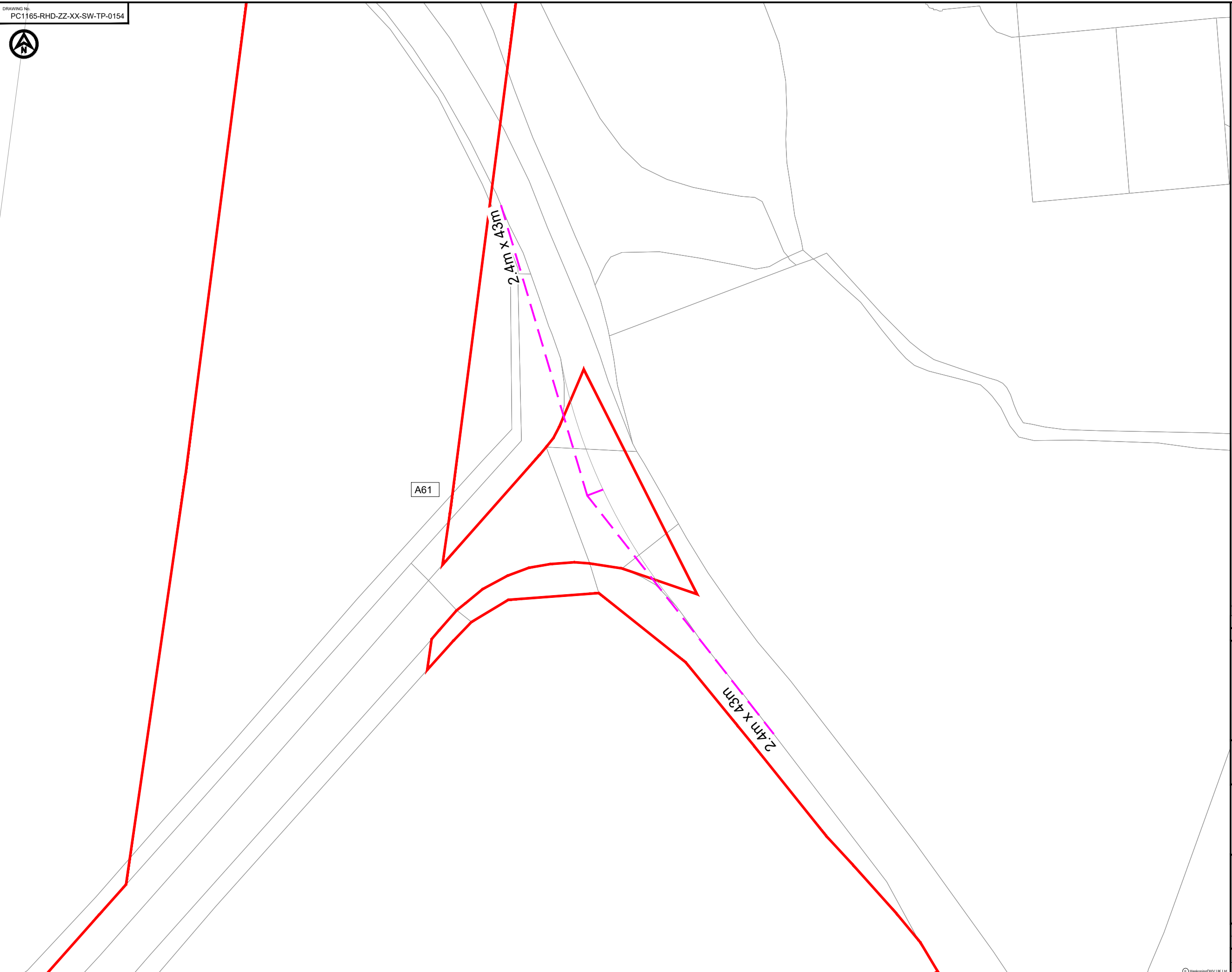

REV	DATE	DESCRIPTION	BY	CHK	APP
P01	20.09.24	FIRST ISSUE	AA	SKT	SKT

REVISIONS

CLIENT

MORECAMBE OFFSHORE WIND FARM LTD AND MORGAN OFFSHORE WINDFARM LTD

PROJECT  
MORGAN AND MORECAMBE OFFSHORE WIND FARMS TRANSMISSION ASSETS

TITLE  
ACCESS A61  
GENERAL ARRANGEMENT



DRAWN	AA	CHECKED	SKT	APPROVED	SKT
DATE	20.09.24	SCALE AT A3	1:500	AUTOCAD REF.	
DRAWING No.	PC1165-RHD-ZZ-XX-SW-TP-0154				REVISION
CLIENT DWG No.					P01



**NOTES**  
 1. Do not scale from this drawing, all dimensions are in metres unless noted otherwise.  
 2. This drawing has been based upon Ordnance Survey Maps and Royal HaskoningDHV can not guarantee the accuracy of data.

**KEY**

- EXISTING ARRANGEMENT
- MORGAN AND MORECAMBE ORDER LIMITS

**VEHICLE TRACKING**

Max Legal Length (UK) Articulated Vehicle (16.5m)  
 Overall Length 16.500m  
 Overall Width 2.550m  
 Overall Body Height 3.681m  
 Min Body Ground Clearance 0.411m  
 Max Track Width 2.500m  
 Lock to lock time 6.00s  
 Kerb to Kerb Turning Radius 6.536m

- VEHICLE BODY SWEEP PATH (FORWARD GEAR)
- VEHICLE CHASSIS SWEEP PATH

REV	DATE	DESCRIPTION	BY	CHK	APP
P01	20.09.24	FIRST ISSUE	AA	SKT	SKT

REVISIONS

CLIENT

MORECAMBE OFFSHORE WIND FARM LTD AND MORGAN OFFSHORE WINDFARM LTD

PROJECT  
MORGAN AND MORECAMBE OFFSHORE WIND FARMS TRANSMISSION ASSETS

TITLE  
ACCESS A61 SWEEP PATH ANALYSIS



DRAWN	CHECKED	APPROVED
AA	SKT	SKT
DATE: 20.09.24	SCALE AT A3: 1:500	AUTOCAD REF:
DRAWING No: PC1165-RHD-ZZ-XX-SW-TP-0155	REVISION	
CLIENT DWG No:		P01